

# 35% Extra 300 ARF

*Assembly Manual*



**HANGAR 9®**

## Notice

All instructions, warranties and other collateral documents are subject to change at the sole discretion of Horizon Hobby, Inc. For up-to-date product literature, visit <http://www.horizonhobby.com> and click on the support tab for this product.

## Meaning of Special Language

The following terms are used throughout the product literature to indicate various levels of potential harm when operating this product:

**NOTICE:** Procedures, which if not properly followed, create a possibility of physical property damage AND a little or no possibility of injury.

**CAUTION:** Procedures, which if not properly followed, create the probability of physical property damage AND a possibility of serious injury.

**WARNING:** Procedures, which if not properly followed, create the probability of property damage, collateral damage, and serious injury OR create a high probability of superficial injury.



**WARNING:** Read the ENTIRE instruction manual to become familiar with the features of the product before operating. Failure to operate the product correctly can result in damage to the product, personal property and cause serious injury.

This is a sophisticated hobby product and NOT a toy. It must be operated with caution and common sense and requires some basic mechanical ability. Failure to operate this Product in a safe and responsible manner could result in injury or damage to the product or other property. This product is not intended for use by children without direct adult supervision. Do not attempt disassembly, use with incompatible components or augment product in any way without the approval of Horizon Hobby, Inc. This manual contains instructions for safety, operation and maintenance. It is essential to read and follow all the instructions and warnings in the manual, prior to assembly, setup or use, in order to operate correctly and avoid damage or serious injury.

## Table of Contents

Intro .....	2
Product Support .....	2
Specifications .....	2
Included Parts .....	3
Contents of Kit and Parts Number .....	4
Safety Precautions and Warnings .....	4
35% Extra 300 Operating Recommendations .....	5
Important Information Regarding Warranty .....	5
Using the Manual .....	5
Aileron Servos Installation .....	7
Elevator Servo Installation .....	11
Rudder Installation .....	13
Tail Wheel Assembly Installation .....	14
Rudder Servo Installation .....	15
Main Gear and Wheel Pants Installation .....	17
Engine and throttle Servo Installation .....	19
In-Cowl Mufflers Installation .....	22
Canisters Installation .....	23
Tuned Pipe Installation .....	25
Receiver and Ignition Battery Installation .....	28
Ignition Module, Switch and Regulator Installation .....	29
Fuel Tank, Fill and Over Flow Installation .....	31
Cowl Mounting .....	33
Pilot Installation .....	33
Receiver, Switch and throttle Servo Regulator Installation .....	34
Satellite Receivers Installation .....	36
Center of Gravity .....	37
Control Throws .....	37
Applying Decals .....	38
Preflight .....	39
Range Test Your Radio .....	39
Safety Do's and Don'ts for Pilots .....	39
Daily Flight Checks .....	39
Warranty and Repair Policy .....	40
Warranty Services .....	40
Compliance Information for the European Union .....	41
2011 Official Academy of Model Aeronautics Safety Code .....	42

## Intro

Pulling from the success of its predecessor, designer Mike McConville built on strengths of the popular 35% Extra 260 to create the new Extra 300, which is undoubtedly his best Extra design yet.

With improved aerodynamic design, and a completely reengineered structure, the Extra 300 offers straight and true flight performance in an airframe designed to stand up to the most extreme acrobatic routines.

Ideal for IMAC competition, freestyle flying or extreme 3D, the Extra will not disappoint.

Finished in a new trim scheme from the creative mind of Mike Hilderbrandt, the Extra is as visible in the air as it is beautiful on the tarmac.

All guess work has been taken out of this ARF— the most popular engine and exhaust choices are covered in this manual.

The Hangar 9® 35% Extra 300 sets a new standard for giant—scale: ease of assembly and world class performance.

Enjoy your new 300 and many happy landings.

## Product Support

For technical assistance with this product, please contact the appropriate Horizon Product Support office.

## Specifications

Wingspan	105 in (2.7 m)
Length	98.0 in (2.5 m)
Wing Area	2003 sq in (129.2 sq dm)
Weight	27.0–30.0 lb (12.2–13.6 kg)
Transmitter & Servos	4-channel (or greater) with 8 servos
Engine	100cc - 120cc gas engine

## Included Parts

### PACKAGED IN KIT

Fuselage with hinged rudder	1
Right horizontal stabilizer with hinged elevator	1
Left horizontal stabilizer with hinged elevator	1
Wings with hinged aileron	1
Cowl	1

### HARDWARE BAGS



Ball Links include 4-40 screws, locknuts and conical spacers



Pushrods

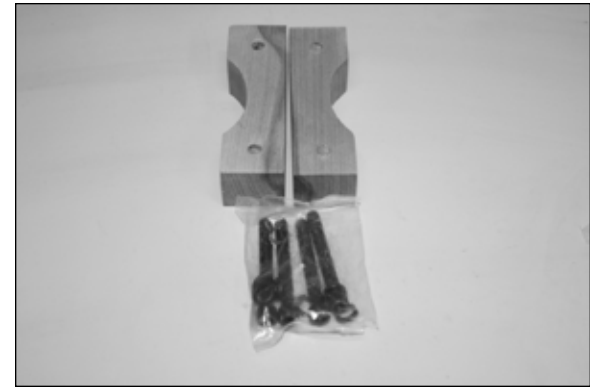

Engine standoffs and bolts

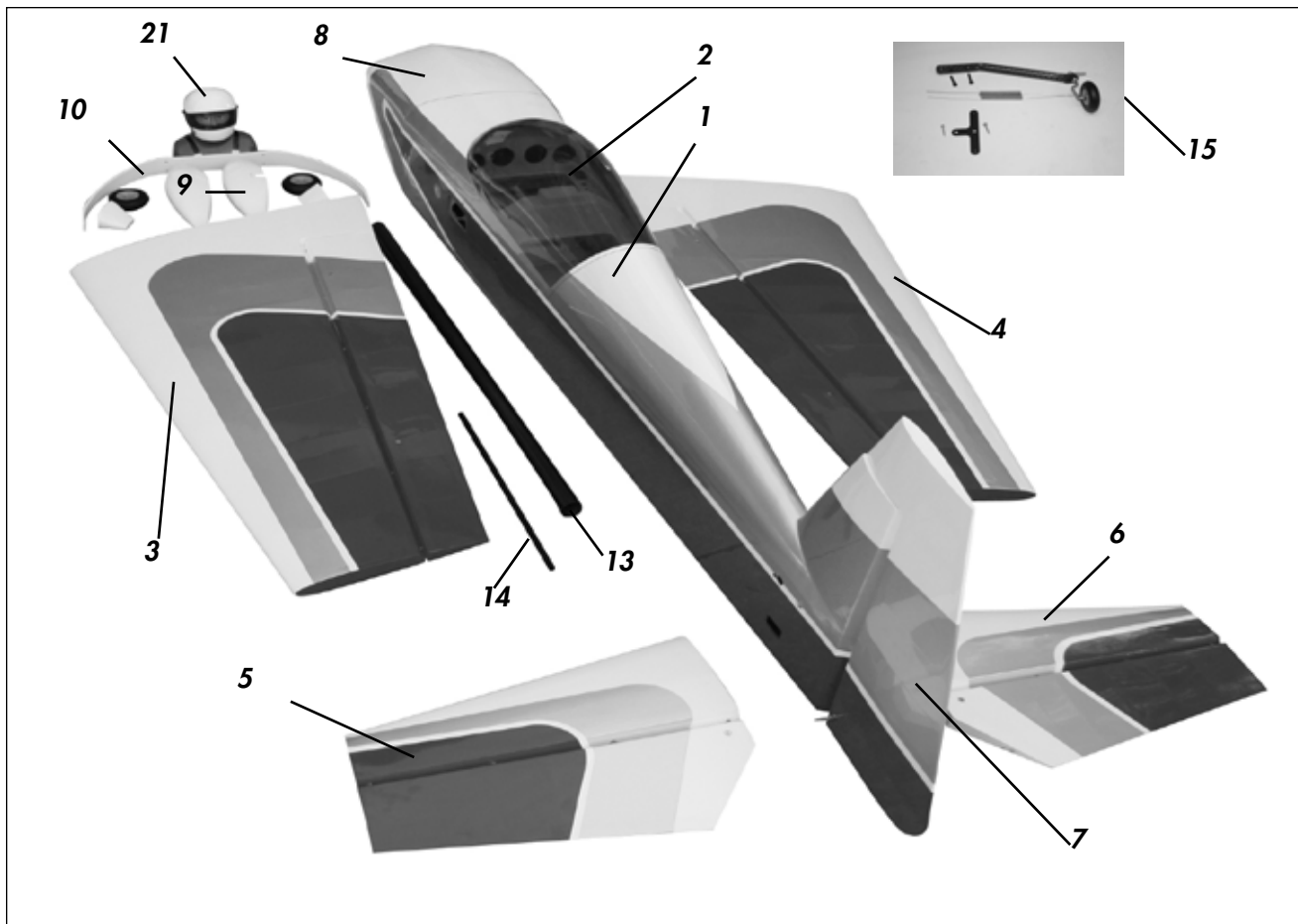

### Contents of Kit and Parts Number

#### Replacement Parts

- 1. HAN105501 Fuselage w/Hatch 35% Extra 300 ARF
- 2. HAN105502 Hatch w/Canopy, 35% Extra 300 ARF
- 3. HAN105503 Left Wing Panel, 35% Extra 300 ARF
- 4. HAN105504 Right Wing Panel, 35% Extra 300 ARF
- 5. HAN105505 Left Stab Panel, 35% Extra 300 ARF
- 6. HAN105506 Right Stab Panel, 35% Extra 300 ARF
- 7. HAN105507 Rudder w/Horn, 35% Extra 300 ARF
- 8. HAN105509 Painted Cowl, 35% Extra 300 ARF
- 9. HAN105510 Wheel Pant Set, 35% Extra 300 ARF
- 10. HAN105511 Painted Landing Gear, 35% Extra 300 ARF
- 11. HAN105512 Linkage Hdwr Set, 35% Extra 300 ARF
- 12. HAN105513 Assembled Gas Tank, 35% Extra 300 ARF

#### Replacement Parts

- 13. HAN105514 Carbon Wing Tube, 35% Extra 300 ARF
- 14. HAN105514 Carbon Stab Tube, 35% Extra 300
- 15. HAN105515 Tailwheel Unit, 35% Extra 300 ARF
- 16. HAN105516 Main Axle Set, 35% Extra 300 ARF
- 17. HAN105517 Exh/Batt Mount Set, 35% Extra 300 ARF
- 18. HAN105518 Cowl/Canopy Screws; 35% Extra 300 ARF
- 19. HAN105519 Decal Set, 35% Extra 300 ARF
- 20. HAN105520 Nylon Wing Bolts, 35% Extra 300 AEF
- 21. HAN376 35% Painted Pilot Helmet Extra 300

## Safety Precautions and Warnings

Read and follow all instructions and safety precautions before use. Improper use can result in fire, serious injury and damage to property.

### COMPONENTS

Use only with compatible components. Should any compatibility questions exist please refer to the product instructions, the component instructions or contact Horizon Hobby, Inc.

### FLIGHT

Fly only in open areas to ensure safety. It is recommended flying be done at AMA (Academy of Model Aeronautics) approved flying sites. Consult local ordinances before choosing a flying location.

### PROPELLER

Keep loose items that can get entangled in the propeller away from the prop, including loose clothing, neck strap or other objects such as pencils and screwdrivers. Especially keep your hands away from the propeller as sever injury can occur. Using a thick glove is highly recommended.

### BATTERIES

#### Notes on Lithium Polymer Batteries

When misused Lithium Polymer batteries are significantly more volatile than alkaline or Ni-Cd/Ni-MH batteries used in RC applications. Always follow the manufacturer's instructions when using and disposing of any batteries. Mishandling of Li-Po batteries can result in fire and rupture causing serious injury and damage.

### SMALL PARTS

This kit includes small parts and should not be left unattended near children as choking and serious injury could result.

#### Age Recommendation:

For advanced fliers ages 14 and above. This is not a toy.

## 35% Extra 300 Operating Recommendations

- Inspect your model before every flight to make certain it is airworthy.
- Be aware of any other radio frequency user who may present an interference problem.
- Always be courteous and respectful of other users of your selected flight area.
- Choose an area clear of obstacles and large enough to safely accommodate your flying activity.
- Make certain this area is clear of friends and spectators prior to launching your aircraft.
- Be aware of other activities in the vicinity of your flight path that could cause potential conflict.
- Carefully plan your flight path prior to launch.
- Abide by any and all established AMA National Model Aircraft Safety Code.

### **Important Information Regarding Warranty**

Please read our Warranty and Liability Limitations section before building this product. If you as the purchaser or user are not prepared to accept the liability associated with the use of this Product, you are advised to return this Product immediately in new and unused condition to the place of purchase.

### **Using the Manual**

This manual is divided into sections to help make assembly easier to understand, and to provide breaks between each major section. In addition, check boxes have been placed next to each step to keep track of each step completed. Steps with a single box (☐) are performed once, while steps with two or more boxes (☐☐) indicate that the step will require repeating, such as for a right or left wing panel, two servos, etc. Remember to take your time and follow the directions.

## **UltraCote® Covering Colors**

- |            |         |
|------------|---------|
| • White    | HANU870 |
| • True Red | HANU866 |
| • Silver   | HANU881 |

### **Recommended Setup—2-Stroke Gas**

- DA100
- DA-120

### **Recommended Spinner**

- 4 1/2-inch silver Tru-Turn Ultimate Style with solid backplate.
- DA120, TT-4552-B-M-DA120 (2-Bladed Prop)
  - DA120, TT-4553-B-M-DA120 (3-Bladed Prop)

### **Optional Tuned Pipe and Canister Installation**

If you are installing the optional tuned pipe, the following items will be required:

- 50mm drop header, 11 1/2-inch long for tuned pipe (MTW, RE2) and 10-inch for canister (MTW TD75)
- Clamps
- Couplers

### **Transmitter Requirements**

The 35% Extra 300 requires a minimum of a 4-channel radio to operate all the functions of your aircraft. However to get the best performance from the Extra, a radio with mixing functions is recommended. We suggest the following radio system available through Horizon Hobby or your local hobby distributor.

Spektrum DX8	SPM8800
Spektrum DX10t	SPM2800US SPM2800
JR DSM2 or DSMX systems	

## **Radio Equipment Requirements**

The following items are recommended when installing the 9-Channel AR9110 (SPMAR9110) in your aircraft:

DS8911HV Digital Servo (7)	JRPS8911HV
JR 537 Servo (1)	JRPS537
3-inch Servo Extension (1) (Regulator)	JSP98100
18-inch Servo Extension (2) (RX to Ailerons)	JRPA099
24-inch Servo Extension (1) (Throttle)	JRPA102
24-inch Servo Extension (2) (Ailerons)	JRPA102
24-inch Servo Extension (1) (Rudder)	JRPA102
36-inch Servo Extension (2)	JRPA103
(2) Receiver Packs, 4000mAh Spektrum	SPMB4000LP
Ignition Pack 2000mAh Spektrum	SPMB2000LP
JR Charge Switch	JRPA004
JR MatchBox (2)	JRPA900
JR 5203 Regulator (2)	JRPVR5203

## ***Additional Required Tools***

Rotary too  
Cut-off wheel  
Drill  
Felt-tipped pen  
Hex wrench: 1.5mm, 3mm, 4mm, 4.5mm, 3/32-inch, 5/32-inch  
Hobby knife with #11 blade  
Mixing stick  
Pencil  
Shoo Goo or Zap-A-Dap-A-Goo  
Phillips screwdriver: #1, #2  
Vise grip  
Rubbing alcohol  
Nut driver: 1/4-inch, 1/2-inch, 9mm  
Heat gun  
Drill bit: 1/16-inch (1.5mm), 5/64-inch (2mm), 3/32-inch (2.5mm), 3/16-inch (5mm), 1/4-inch (6.35mm)

Sanding drum  
Epoxy brush  
Ruler  
Iron  
Mixing cup  
Paper towel  
Hemostat  
Pin vise  
Masking tape

## ***Additional Required Adhesives***

Medium CA (PAAPT02)  
Thin CA (PAAPT08)  
CA remover/debonder (PAAPT16)  
CA accelerator (PAAPT15)  
Blue Threadlock (PAAPT42)  
30-Minute Epoxy, 8 oz (PAAPT39)

## ***Before Starting Assembly***

Before beginning the assembly of your model, remove each part from its bag for inspection. Closely inspect the fuselage, wing panels, rudder and stabilizer for damage. If you find any damaged or missing parts, contact the place of purchase.

If you find any wrinkles in the covering, use a heat gun or covering iron to remove them. Use caution while working around areas where the colors overlap to prevent separating the colors.



**HAN100 – Heat Gun**

**HAN150 – Covering Glove**



**HAN101 – Sealing Iron**

**HAN141 – Sealing Iron Sock**

## Aileron Servos Installation

### Required Parts

Wing panel  
Control horns (4)  
Aileron pushrod (4)  
Ball link (4)

### Required Parts (not included)

JR 8911HV with hardware (4) or similar digital servo  
JR 1-1/4-inch servo arm (4)  
JR heavy-duty servo extension, 24-inch (2)  
JR MatchBox™ (2)

### Required Tools and Adhesives

Pin vise  
Thin CA  
Drill bit: 1/16-inch  
Adhesive-backed hook and loop  
3/32-inch ball driver  
Dental floss (string)  
Phillips screwdriver: #1  
Masking tape  
Scissors

1. Prepare the aileron servos by installing the rubber grommets and brass eyelets.

**Hint:** Prepare all servos for the wing at this time.



2. Secure a 24-inch servo extension to the outboard aileron servo lead using string or a commercially available connector. This will prevent the extension from accidentally disconnecting inside the wing.

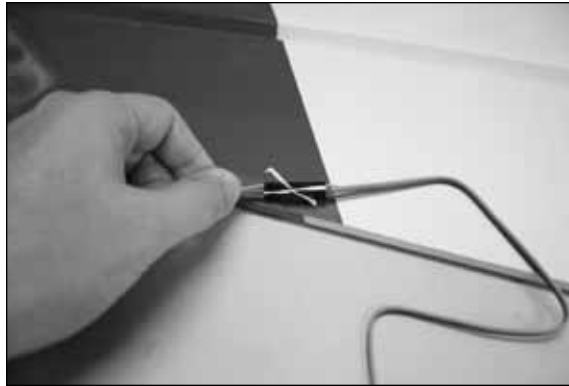

3. Apply a piece of masking tape around the connector and over the string.

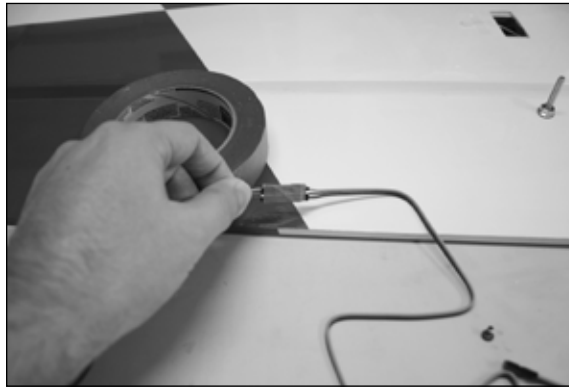

4. A string has been installed in the wing to pull the aileron servo extension through the wing. Tie or tape the string to the end of the extension and pull the lead to the wing root.

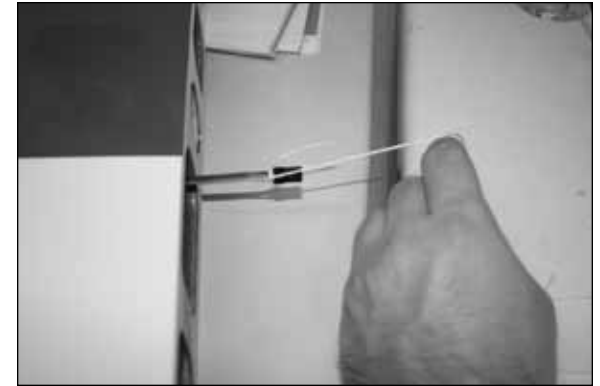
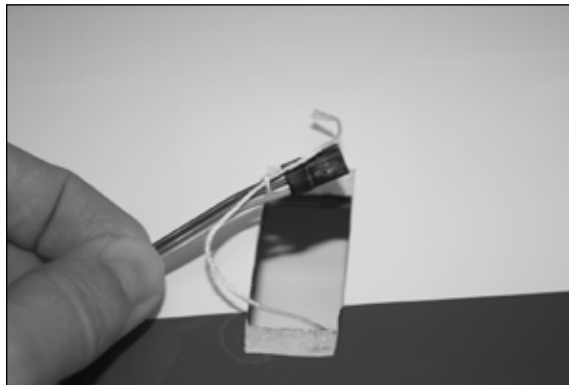

5. Mount the servo so the output shaft is facing toward the trailing edge and mark the servo mounting lugs location.



6. Remove the servo. Using a pin vise, drill the servo mounting screw locations.

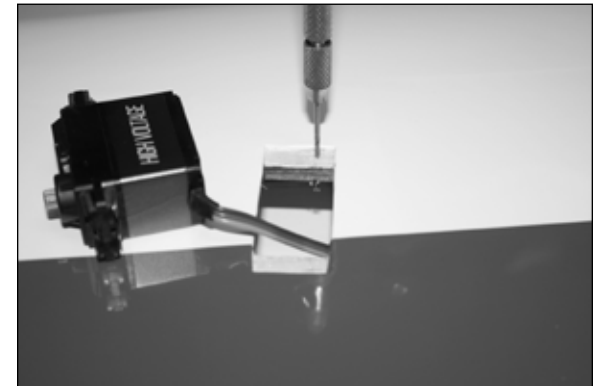

7. In order to harden the servo mounting holes in the bays, mount the servo screws, back them out and apply some thin CA in the hole. Wait until CA is dry before

installing the servo.

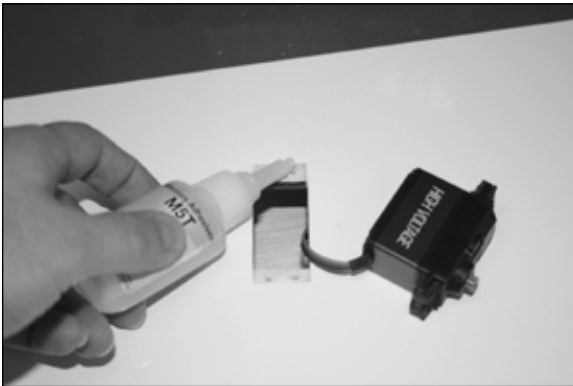
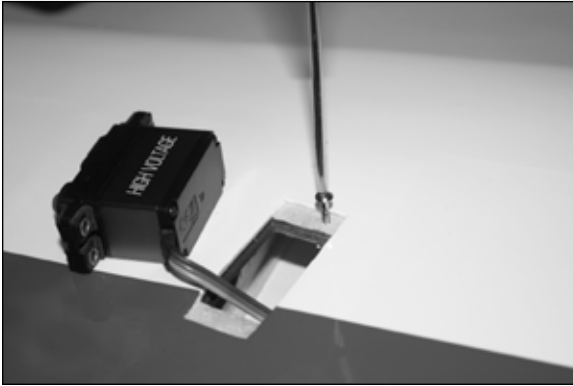

□□ 8. Install the servo.

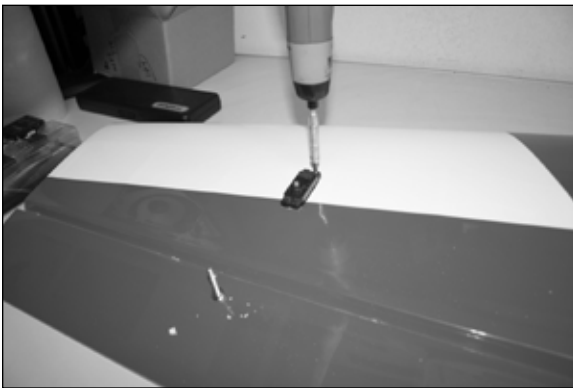

□□ 9. Prepare the linkages and servo arm for outboard servo installation.



Order of ball link assembly is bolt through the ball link, conical spacer with flat end facing the servo arm, servo arm and then nut.



□□ 10. Attach the linkage to control horn and ball link.



□□ 11. Screw on the control horn so the distance **from the hinge line** to the center of the pivot point measures 1 1/2-inch.

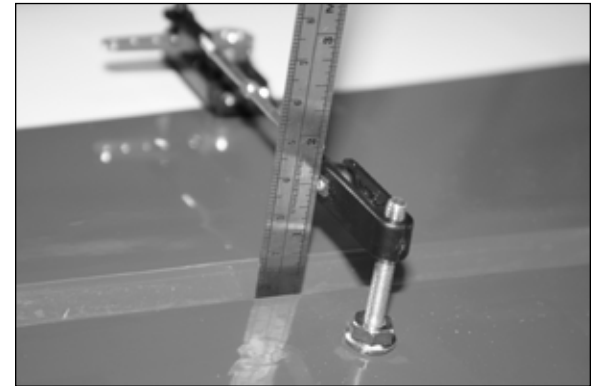

□□ 12. Attach the ball link to 1 1/4-inch servo arm hole; in case of JR servo arm, this is the second outermost hole.

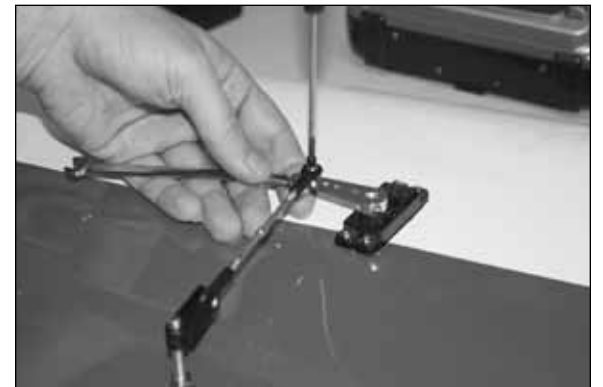

□□ 13. Connect the servo to the MatchBox and receiver, with radio sub-trim at 0, install the servo arm onto the servo



on the spline that gets it as close to parallel to the hinge line as possible. If necessary, use the sub trim in the transmitter to adjust the neutral position so the arm is parallel to the hinge line. Attach the linkage to the servo arm and adjust the length using a Hangar 9 Pro-Link™ adjustment tool so the aileron is at the neutral position.

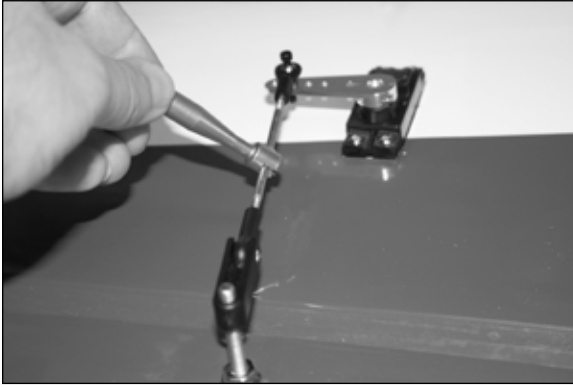

□□ 14. Apply a drop of threadlock on the servo arm center screw and tighten.



□□ 15. Tighten the servo arm setscrews. Do not use threadlock on these screws.

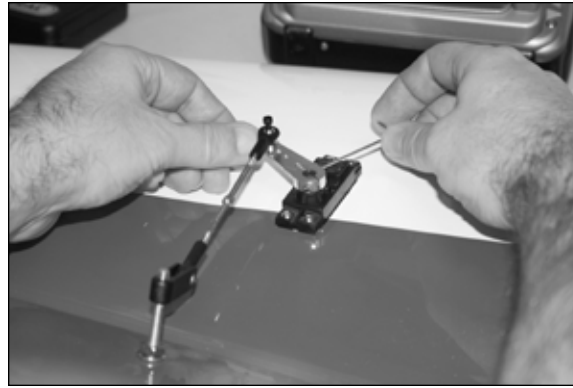

□□ 16. Mount the inboard servo following the same method as outboard but no extension is required. Tie a knot using the string that has been attached to the servo bay and pull the servo lead through the root rib as shown.



□□ 17. Mount the servo so that the output shaft is toward the trailing edge. Follow the same steps in marking and making the servo mounting holes as the outboard servo.



□□ 18. Assemble the servo linkage following the same steps as the outboard servo. Make sure to set the distance of center of the control horn pivot to the aileron hinge at 1 1/2 inch.

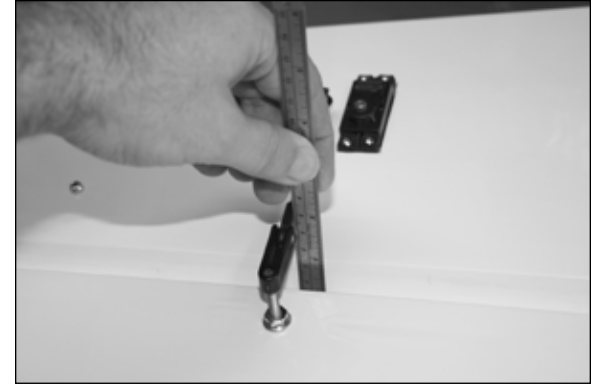

□□ 19. Connect the servo to the Matchbox and refer to the MatchBox Programming Hints on page 10 for final setup.



□□ 20. The picture below shows both servos installed.

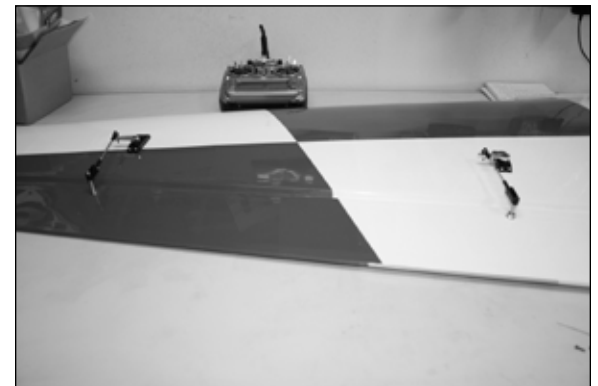

21. Apply a piece of masking tape to the back of the MatchBox.



22. Glue a piece of hook and loop using CA to the masking tape.

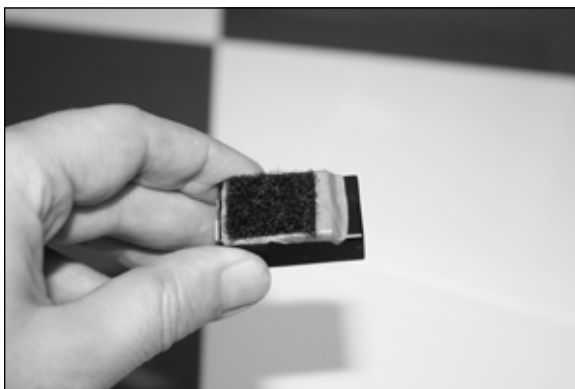

23. Glue opposite side of hook and loop using CA to the root of the wing panel.

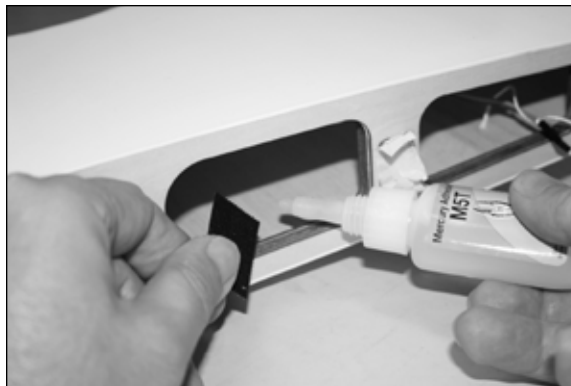

24. Connect the inboard and outboard servo leads to the MatchBox and mount the MatchBox in the root.



## MatchBox Programming Hints

The pointers below can help make matching servos easier. This is not to take the place of the MatchBox instruction manual.

1. Connect the outboard servo to the MatchBox and then make all adjustments to servo center and travel adjustments in the transmitter programming. No adjustments to this servo should be made in the MatchBox.

2. Connect the inboard servo to the MatchBox, then install the servo arm onto the servo on the spline that gets it as close to parallel with the hinge line as possible. Then use the MatchBox to set the center of this servo so the servo arm is exactly parallel to the hinge line. Now adjust the linkage length so the hole in the ball link directly aligns with the appropriate hole in the servo arm.

Deflect the servo to full stick in one direction and use the MatchBox to set the endpoint so the ball link directly lines up with the hole in the servo arm. Repeat this with the stick fully deflected in the opposite direction. Once the center and both endpoints are set for the second servo, remember to turn the dial on the MatchBox back to the 0 position to save the settings before powering off the receiver. Hint, when adjusting for endpoints (full deflection), it is hard to hold the sticks and adjust the MatchBox at the same time. It is best to move the sticks to full deflection and while holding the stick, turn off the radio. This will put the receiver into hold and makes adjustment easier working only the MatchBox and observing the linkage position over the servo arm.

## Elevator Servos Installation

### Required Parts

- Elevator panel
- Ball link (2)
- Control horns (2)
- Elevator pushrod (2)

### Required Parts (not included)

- JR 8911HV or similar digital servo (2)
- JR 1 1/2-inch servo arm (2)
- JR heavy-duty servo extension, 36-inch (2)

### Required Tools and Adhesives

- Pin vise
- Thin CA
- Drill bit: 1/16-inch
- String (Dental floss)
- 3/32-inch ball driver
- Phillips screwdriver: #1
- Masking tape

Note: It is important to go over the covering with covering iron and make sure all the seams are sealed.

- 1. Prepare the servo by installing the rubber grommets and brass eyelets.



The servo needs to be installed in such a way that the output shaft is towards the leading edge of the stab. The servo arm needs to be 1 1/2 inch. If using a JR aluminum servo arm, this would be the third outermost hole.

- 2. Mount the servo and mark the servo mounting holes.



- 3. Using a pin vise, drill the servo mounting screw.



- 4. In order to harden the servo mounting holes in the bays, mount the servo screws, back them out and apply some thin CA in the hole. Wait until CA is dry before installing the servo.



- 5. Secure a 36-inch JR Heavy-Duty extension using a string or commercially available safety connector.

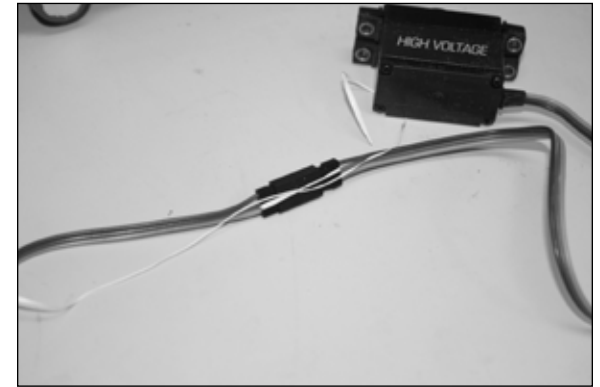

- 6. Apply a piece of masking tape over the knot holding the leads.

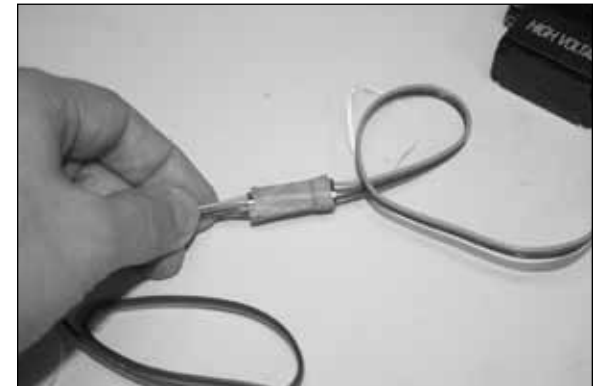

- 7. For removable stab setup, do not connect the extension to the elevator servo, instead run a 36-inch extension through the fuselage and exit from stab mounting

hole. Use a commercially available safety connector instead of the string and masking tape to secure the connector.

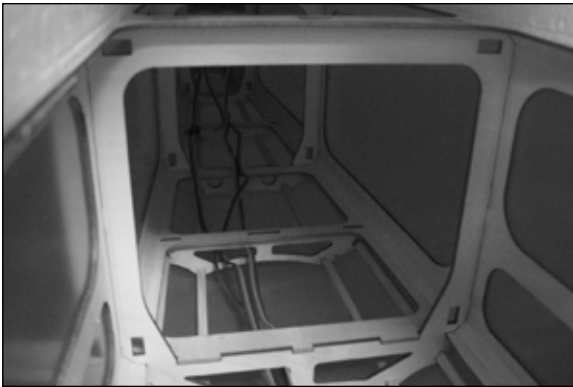
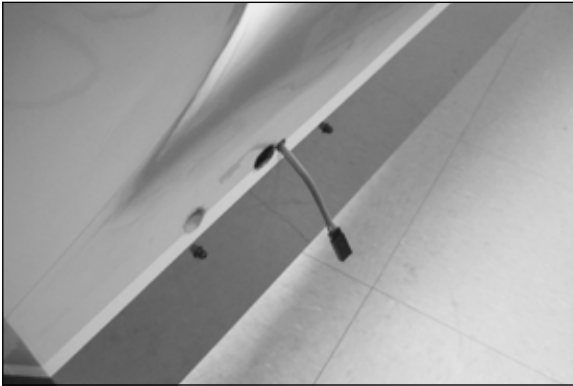

□□ 8. Mount the servo so that the output shaft is closer to the leading edge of the elevator. Pass the extension through the slot provided in the root of the elevator panel.



The picture below shows the slot that extension needs to exit from.



□□ 9. Prepare the linkage and control horn for installation.



□□ 10. Screw on the control horn so that the distance from the elevator hinge line to the center of the pivot point of the horn is 1 3/8 inch.

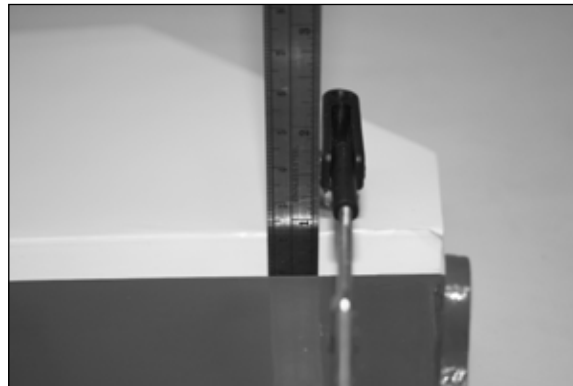

11. Power up the servo by connecting it to the receiver. With radio sub-trim set at 0.



□□ 12. Mount the servo arm so it is perpendicular to the center line of the stab, make adjustment to sub-trim if necessary.



□□ 13. Apply a drop of threadlock to the servo center screw and tighten the screw. This is the outer hole in the JR Aluminum arm.

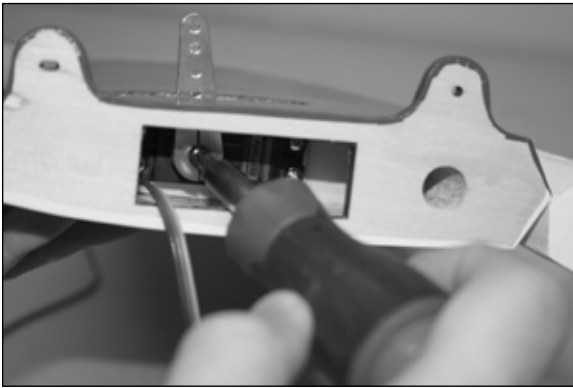

□□ 14. Tighten the servo arm setscrews. Move the servo arm all the way to the front and back to access the mounting lugs.

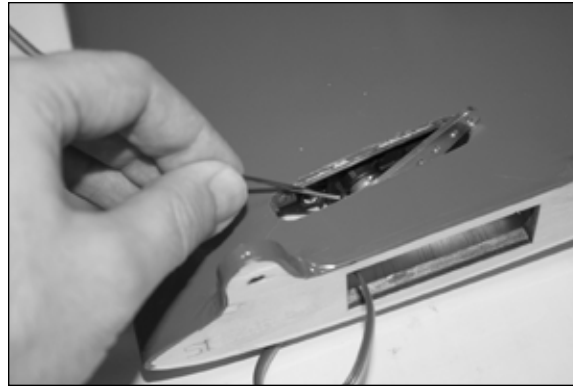

□□ 15. Connect the ball link to 1 1/2-inch servo arm. In case of JR Aluminum servo arm, this is the outermost hole. Insert the ball link screw into the ball link through the conical spacer (flat surface facing the arm) and servo arm and then nut.

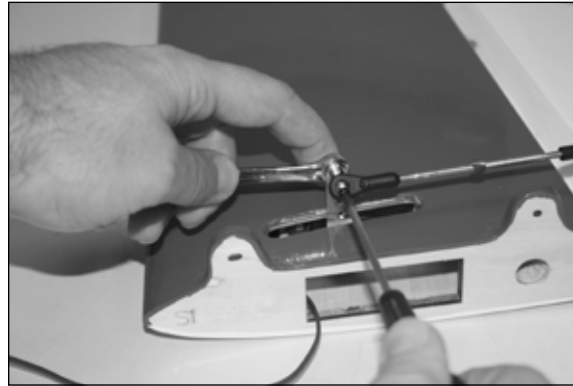

□□ 16. With servo arm perpendicular to the center line of the stab, use a Hangar 9 Pro-Link Wrench to adjust the linkage so the elevator is at neutral position.

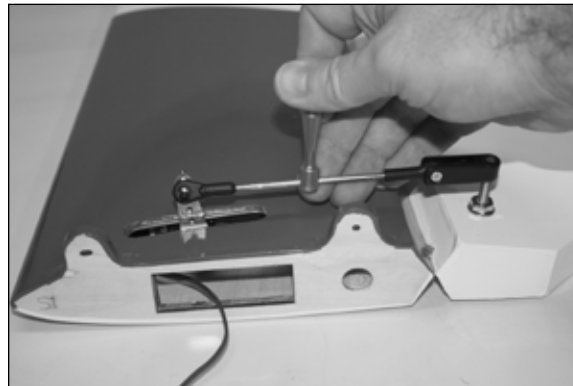

## Rudder Installation

### Required Parts

Fuselage	Rudder
Hinge rod	

### Required Tools and Adhesives

Drill	Pliers
Petroleum Jelly/Industrial Lubricant	

□ 1. Apply some industrial lubricant to the rod. Pass the rod through the hinges in the rudder and fuselage vertical fin separately. This helps remove any possible dirt in the hinges and makes for easier final assembly.

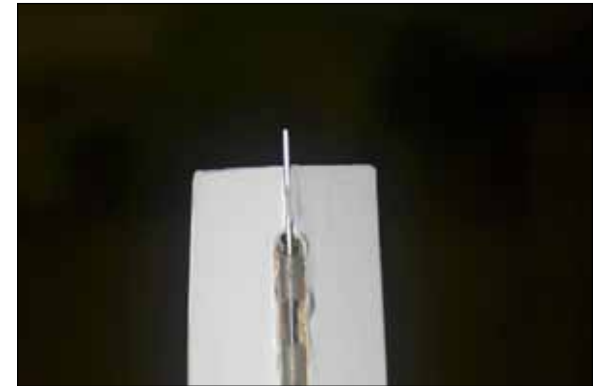
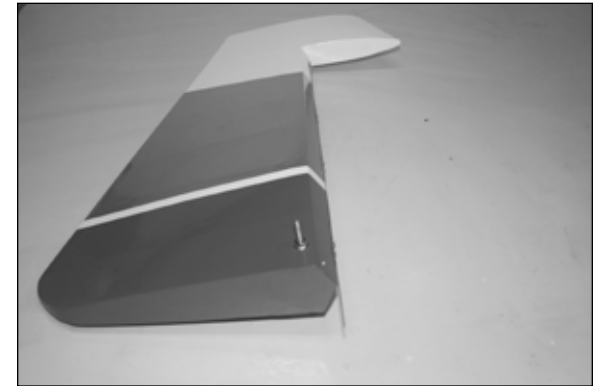

□ 2. Mate the rudder and fuselage vertical stabilizer and carefully pass the rod through hinges. This can be accomplished by two ways. 1. Use a drill on slow speed and gently pass through the rod. If there is any resistance, back out and repeat. 2. Use a pair of pliers and push the rod through the hinges. Make sure not to buckle the rod. This is a rather slow process and needs attention.



3. Cut excess rod long enough (1mm) that it is easy to grab and pull out when needed for transportation. The tail wheel bracket will stop the rod from backing out of the hinges.



The picture below shows the rod when cut.



## ***Tail Wheel Assembly Installation***

### **Required Parts**

Tail gear and screws	Springs
T-bracket and screws	

### **Required Tools and Adhesives**

2.5mm and 7/64-inch ball driver	
Blue threadlock	Felt-tipped pen
Thin CA	Pin vise

1. Mount the T-bracket so it is parallel to the rudder horn bolt and mark using a felt-tipped pen.

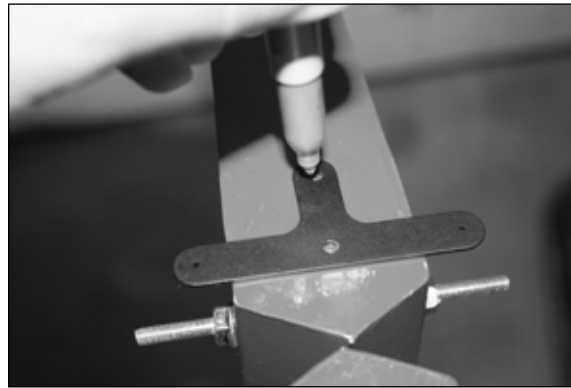

2. Using a pin vise, drill the marked spots.

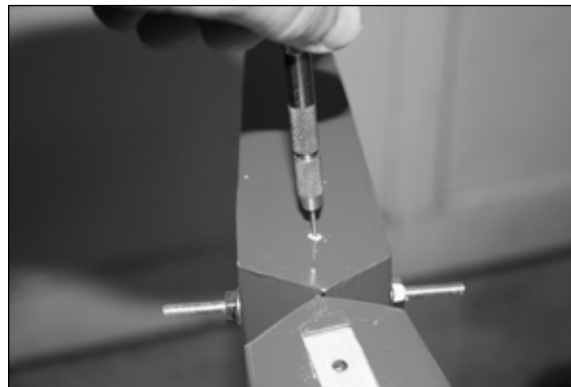

3. Mount the sheet metal screws provided and back them out.

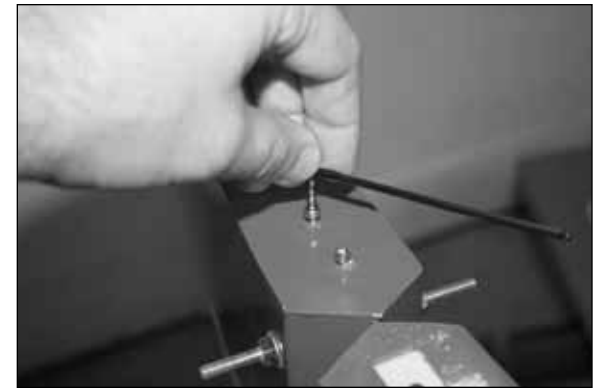

4. To harden the wall, apply some thin CA into the holes. Wait until CA is dry before installing the T-bracket.

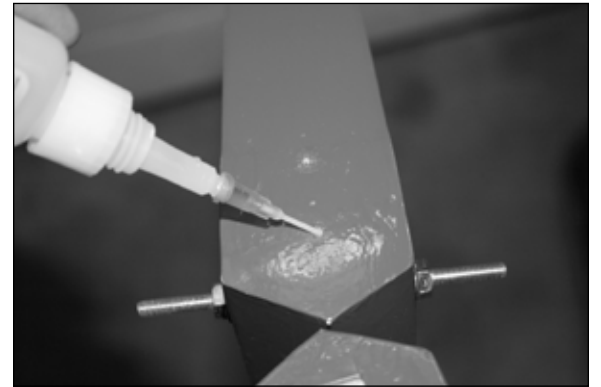

5. Apply threadlock to the tail gear bolts.



- 6. Mount the tail gear.



- 7. Hook the springs to the T-bracket from the tiller arm. Pass through the hole and wrap the spring around the arm a couple of times.

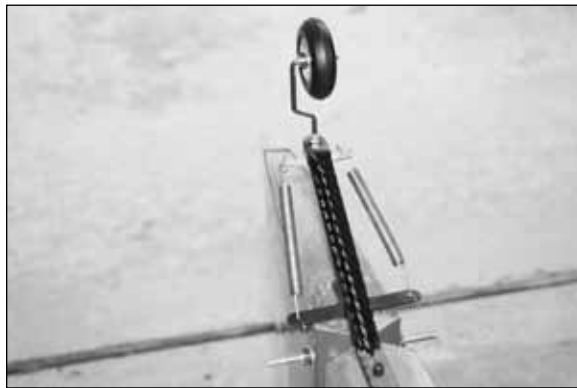

## **Rudder Servo Installation**

### **Required Parts**

- Fuselage
- Ball link (1)
- Rudder pushrod (1)

### **Required Parts (not included)**

- JR 8911HV or similar digital servo (1)
- JR 1.5-inch servo arm (1)
- JR heavy-duty servo extension, 24-inch (1)

### **Required Tools and Adhesives**

- Pin vise
- String (Dental floss)
- 3/32-inch ball driver
- Phillips screwdriver: #1

Note: The fuselage is made to accept 2 rudder servos, however if the recommended servo is used, only one servo is needed even for the most extreme 3D flying. For lower torque servo, use two servos.

- 1. Prepare the servo by installing the rubber grommets and brass eyelets. Attach the 24-inch extension and secure the connector with a piece of dental floss (string).

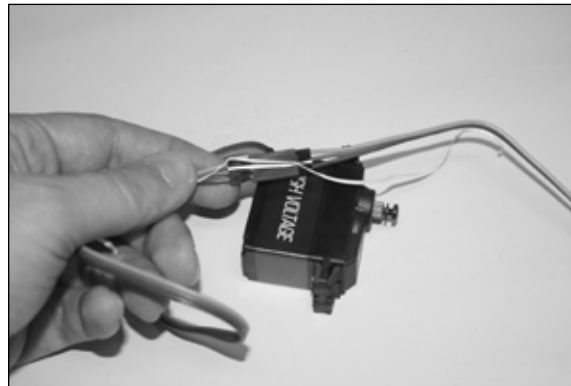

- 2. Apply a piece of masking tape over the knot holding the leads.



- 3. Mount the servo so the output shaft is closer to the rudder hinge line and mark the mounting lugs.

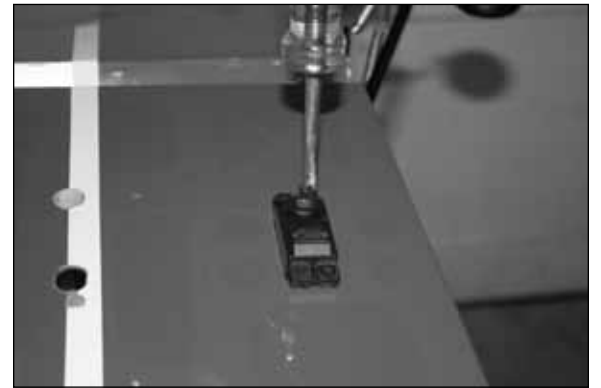

- 4. Using a pin vise, drill the marked spots.



- 5. Mount the servo screws and back them out, then

apply some CA to harden the wall. Once CA is dry, mount the servo.

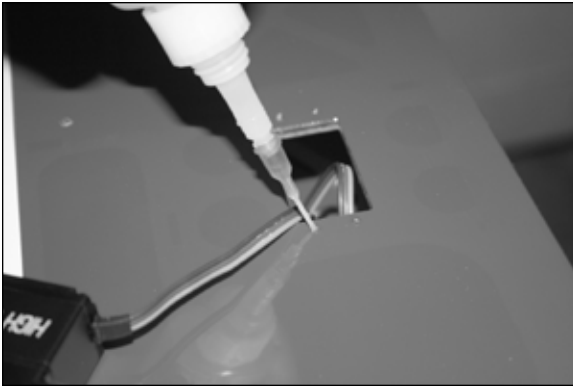
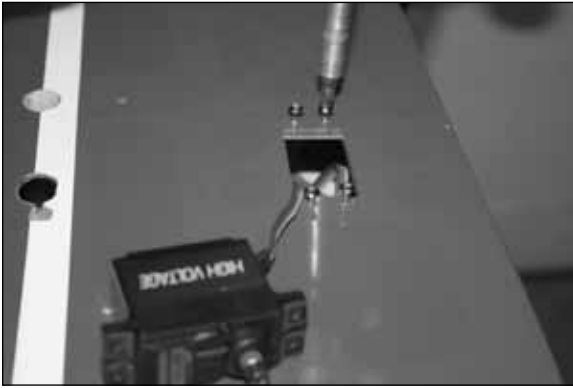

□ 6. Prepare the servo linkage.

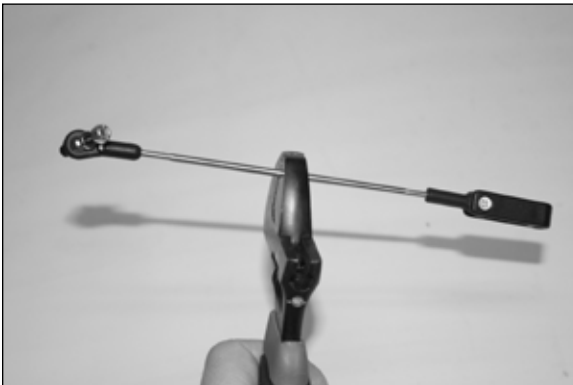

□ 7. Mount the control horn. Adjust the height to 1 7/8 inch from the rudder hinge line to the center of the pivot point on the horn.

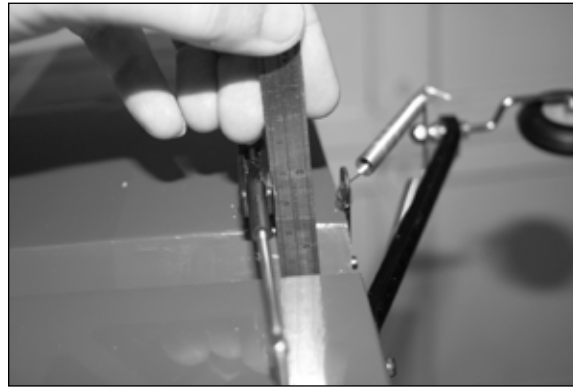

□ 8. Attach the ball link to 1 1/2-inch servo arm.

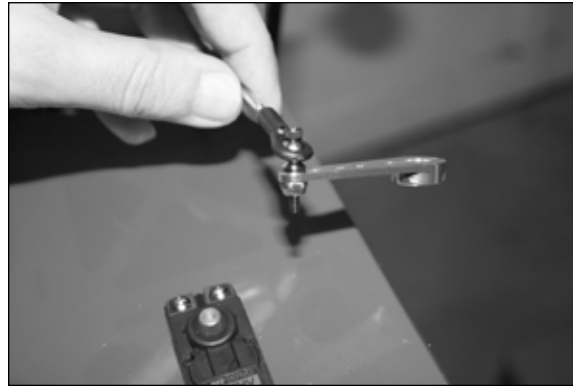

□ 9. Power up the servo by connecting to the receiver and with radio sub-trim at 0, mount the arm towards the bottom of the aircraft and parallel to the hinge line.



□ 10. Apply threadlock to the servo center screw and mount the servo arm.

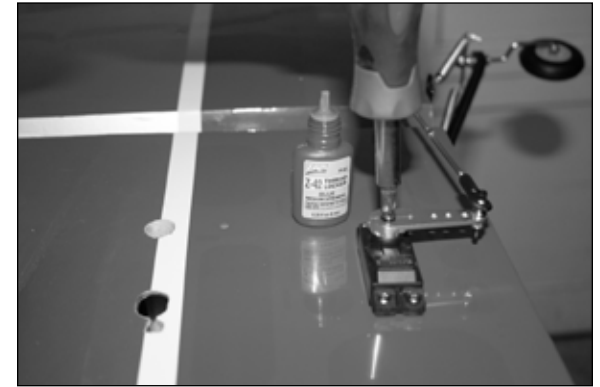

□ 11. Mount the servo arm setscrews.



□ 12. Using a Hangar 9 Pro-Link Wrench, adjust the length of the linkage so when the servo arm is parallel to the rudder hinge line, rudder is at center.





## Main Gear and Wheel Pants Installation

### Required Parts

Landing gear	5/32-inch axles (2)
Wheel collars (4)	4mm bolts (4)
Locknuts (4)	4-40 screws (4)
Lock washers (4)	Washers (4)
Wheel pants (2)	Wheels (2)

### Required Tools and Adhesives

3mm ball driver	9mm socket
Crescent wrench	1/2-inch wrench
Threadlock	Felt-tipped pen
Thin CA	Shoo Goo
3/32-inch ball driver	

1. Locate all the hardware necessary to mount the wheels and wheel pants. Gear is mounted swept forward.



2. Pass the cuffs through the landing gear legs as pictured below so it fits the contour of the fuselage. Try the cuff and gear on the fuselage if in doubt about orientation.



3. Install the axle using an 1/2-inch nut wrench and crescent wrench.



4. Each wheel axle has two flat spots. Install the wheel using the two wheel collars provided; apply threadlock to the setscrews and tighten them. The wheel needs to rotate freely and be centered.



5. Apply threadlock to the wheel pant screws.



□ 6. Install the wheel pants. The order of installation is: bolts, lock washers then washers.



□ 7. The wheel needs to be in the center of the pant as in the picture below. If the wheel is rubbing against the wheel pant, make sure to correct this by loosening the wheel collars and adjusting the wheel position.



□□ 8. Once both wheel pants and wheels are assembled, the gear should look like this.



□□ 9. To install the landing gear to the fuselage, use a long 3mm ball driver and #9 socket. It is also helpful to have a magnet to insert the landing gear bolt and washers from the top of the fuselage into the plate. The picture below shows the tools needed to install the landing gear.

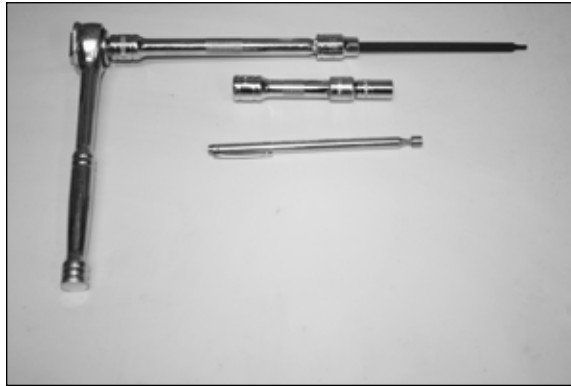

□□ 10. Use the long 3mm ball driver from the top and socket from the bottom to tighten the landing gear to the fuselage.

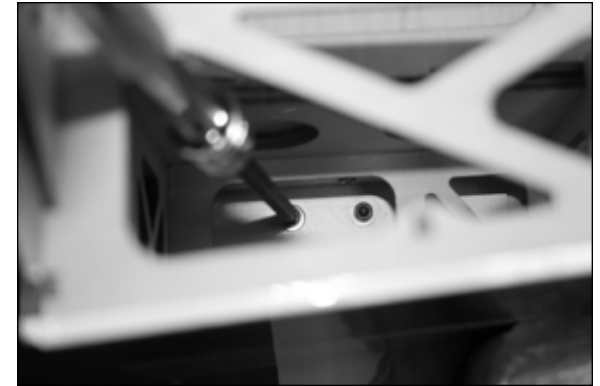

□□ 11. Once the landing gear is secured, pull up the cuffs until they touch the fuselage and mark the bottom of the cuffs onto the landing gear with a felt-tipped pen.



□□ 12. Apply Shoo Goo to and above the marked spots.



13. Pull the cuffs up and clean the marking and excess Shoo Goo with alcohol swabs.

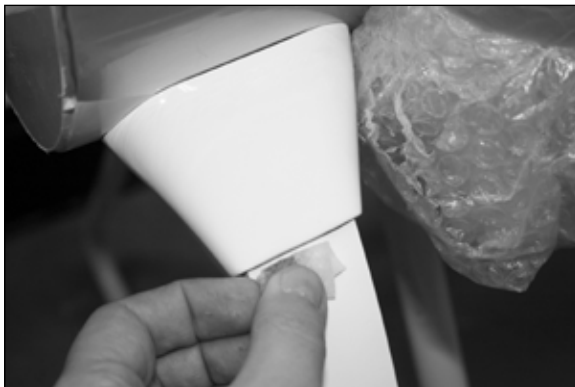

## Engine and Throttle Servo Installation

### Required Parts

Fuselage	Wood plate
----------	------------

### Required Parts (not included)

DA-120 Engine	DA stock mufflers
JR-537 servo (1)	
JR 24-inch servo extension	

### Required Tools and Adhesives

Threadlock	4.5mm hex wrench
Hobby knife with #11 blade	Felt-tipped pen
Pin vise	
#1 Phillips screwdriver	
Rotary tool with sanding drum	
30-minute epoxy	
Acid brush	Mixing cup

1. Mount the engine using 1/4-20 bolts and wood spacers provided and make sure to apply threadlock to all the bolts. Opening of wood spacers should face the engine box cutout.

The picture below shows the wood spacers and bolts.



The following pictures show engine installation.

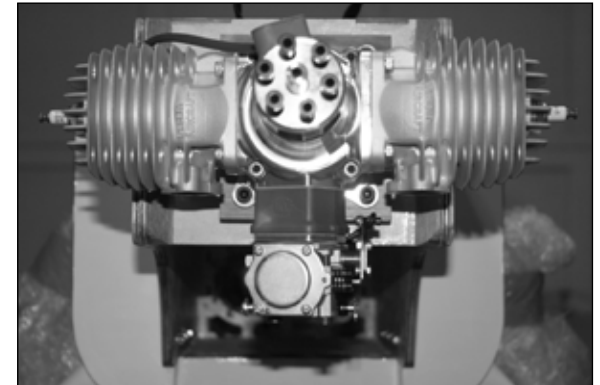

2. Prepare the throttle servo by inserting the rubber grommets and brass eyelets.

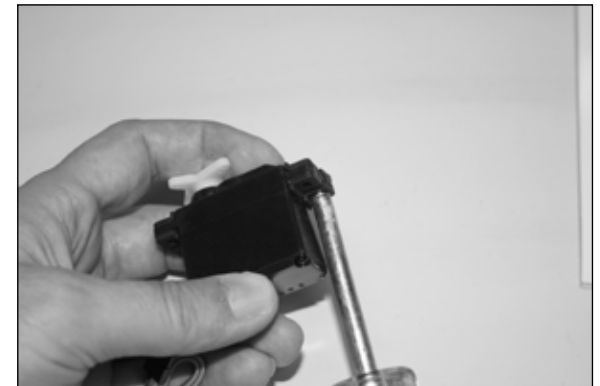

3. Attach a 24-inch extension. Secure the leads with dental floss and apply a piece of masking tape over the connectors.

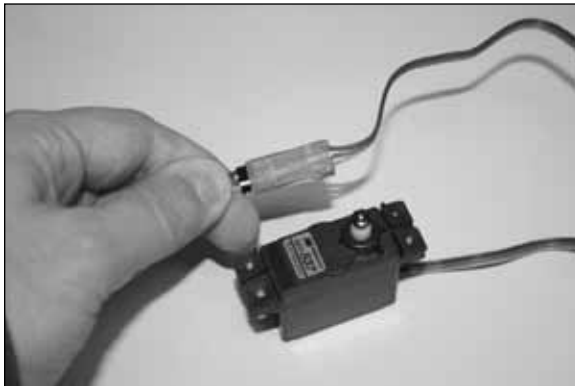
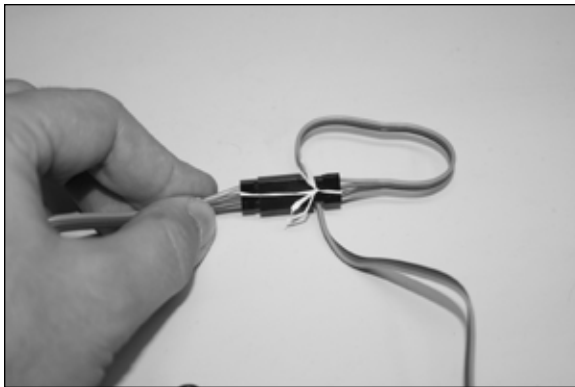

□ 4. Mount the throttle servo so that the servo output shaft is closer to the front of the engine. Mark the mounting holes and drill the holes using a pin vise.

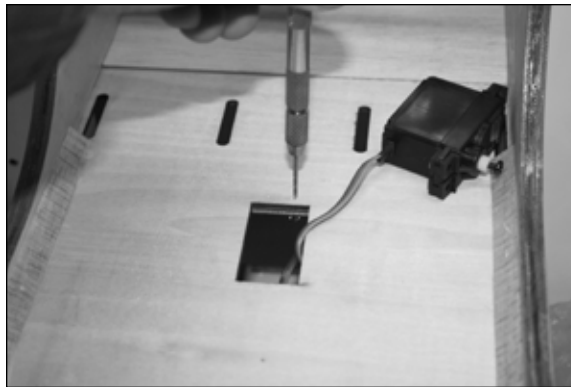
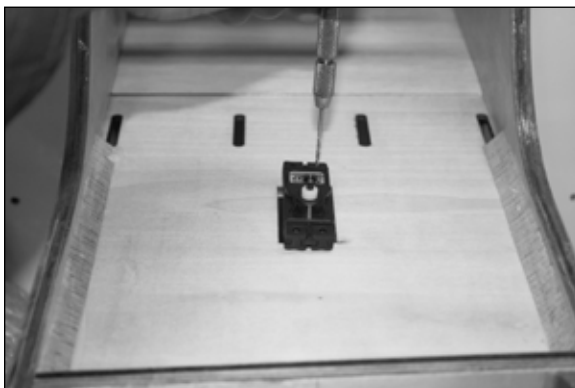

□ 5. To harden the mounting walls in the wood, install the servo screws and back them out. Then apply thin CA into the holes. Once CA is dry install the servo. The pictures below show this process sequentially.

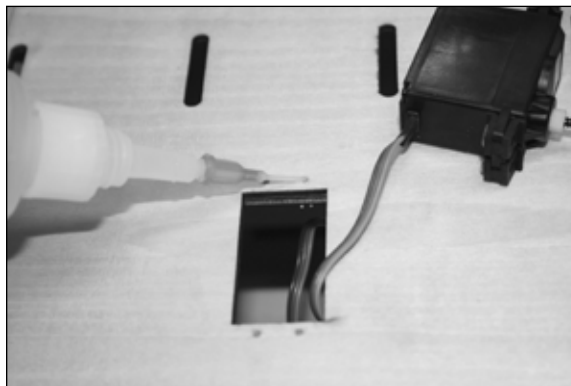
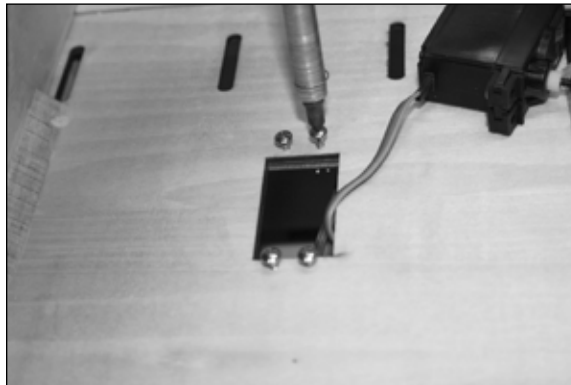

□ 6. Prepare the throttle servo linkage by attaching the ball links to the ends. Note the ball link should be mounted below the servo arm as pictured.



□ 7. Slightly enlarge DA throttle arm hole by drilling with 3/32-inch and then 7/64-inch drill bits to accept the 4-40 ball link.



□ 8. Install the throttle linkage to the engine throttle arm.

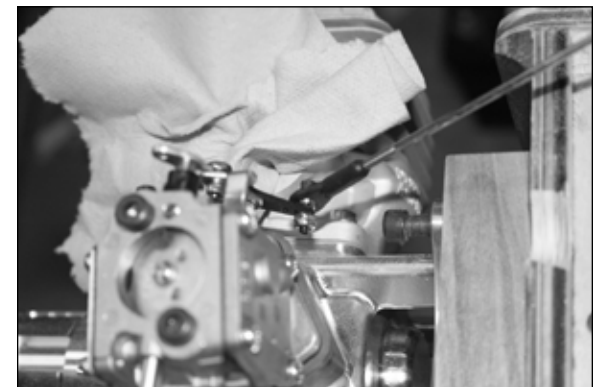

9. Mark where the throttle linkage touches the engine box.

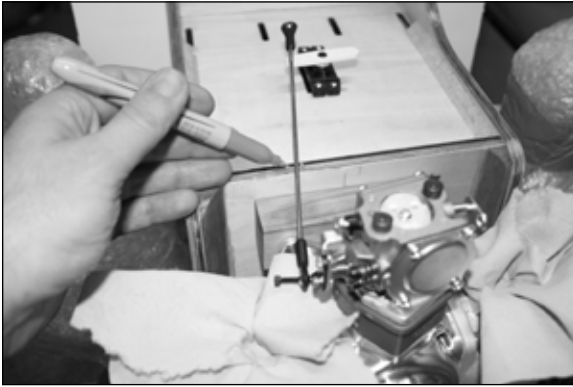

10. Using a rotary tool and sanding drum, remove some of the edge of the engine box so the throttle linkage has a straight shot to the engine throttle arm with no binding.

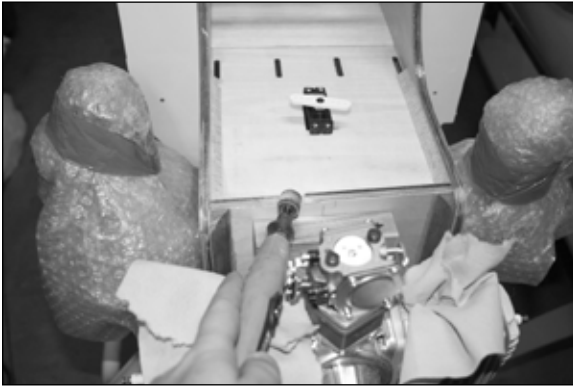

11. Complete the throttle linkage installation by powering servo and making adjustments through the radio.

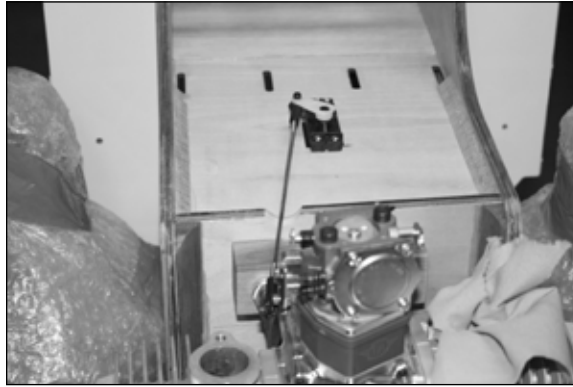

## In-Cowl Mufflers Installation

### Required Parts

Fuselage Wood plate

### Required Parts (not included)

DA compact mufflers

### Required Tools and Adhesives

Threadlock 4mm hex wrench  
Rotary tool Sanding drum  
Cutting wheel

**NOTICE:** Always refer to the product's instructions for installation, use and safety.

 **WARNING:** This product can become extremely hot when in use, which could lead to burns.

1. Prepare the DA compact mufflers by inserting the gasket and bolts in the muffler. Apply threadlock on the bolt.



2. Using a 4 mm ball driver, bolt on the mufflers such that DA logo is facing the front of the airplane and stacks are towards the aft of the engine.

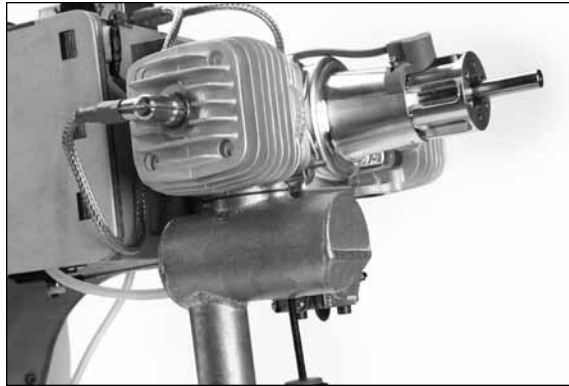

3. Bottom of the cowl needs to be opened to accommodate DA compact muffler. Mark how much the cowl needs to be opened. Using a rotary tool and cutting disk, open the cowl little by little until reaching correct size.

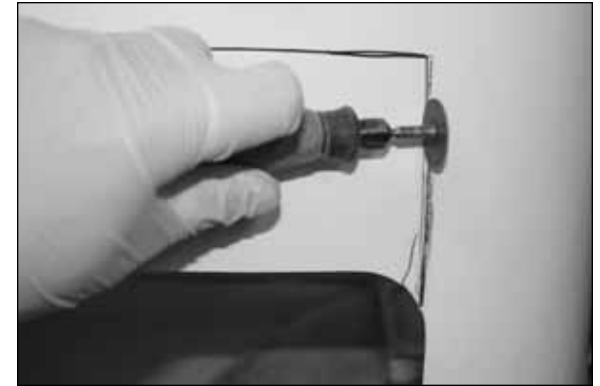

4. Use a sanding drum to shape the stacks on the cowl.



5. When using compact mufflers, the canister tunnel opening can be blocked off by the wood plate provided.

## Canister Installation

### Required Parts

Silicone tubing

### Required Parts (not included)

MTW 75 Canister

50mm drop header, 10 1/2-inch header length for MTW

TD75 canister setup

Couplers

Clamps

### Required Tools and Adhesives

Hobby knife

Clamps

Vise grip

Masking tape

Acid brush

Ruler or caliper

Cutting wheel

Felt-tipped pen

Hobby knife

Iron

Industrial lubricant

Mixing cup and sticks

Rotary tool

□ 6. Mix 30-minute epoxy and glue the wood plate in place to block the canister tunnel.



□ 1. The model comes with the canister mount already installed. Remove the covering from the bay behind the canister mount by applying 4 pieces of masking tape along the edges of the section that need to be opened for canisters. Use a hobby knife to remove the covering.

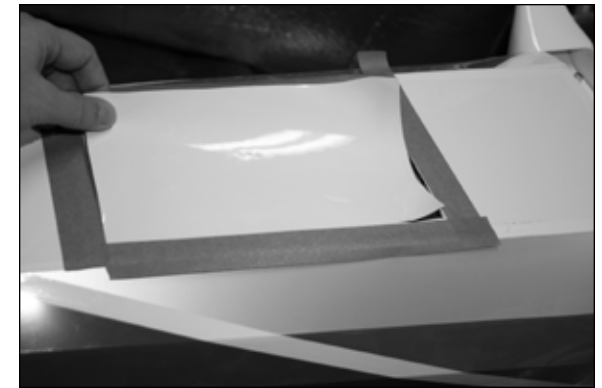

□ 2. Iron down the edges of the tunnel and remove any excess covering that may catch air in flight.

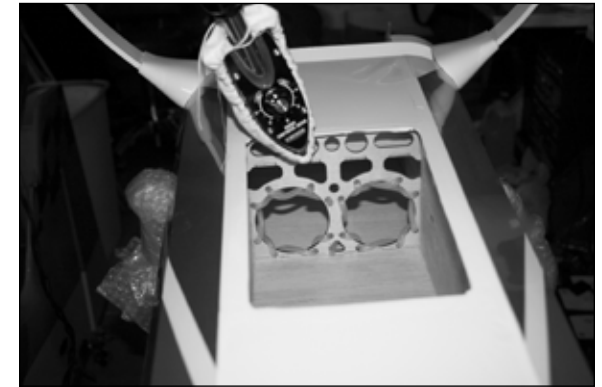

□ 3. Pass the silicone tubing through the upper middle hole and go through each hole in the circumference of the mount from the inside until you are back at the same middle hole that you started. Cut off the silicone tubing once finished. Follow the next 3 pictures as reference.





The picture below shows how the mount looks after silicone tubing is properly wrapped around the canister mount.

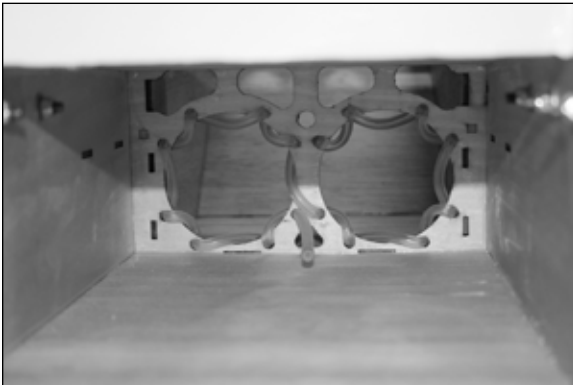

4. Recommended header length for MTW TD75 canister and DA-120 is 10 1/2-inches.



5 Assemble the canister/header using a vice-grip to open the clamps and slide them over the header.



6. Insert the header and canister into the coupler. Leave 1/8--1/4-inch gap between header and pipe.

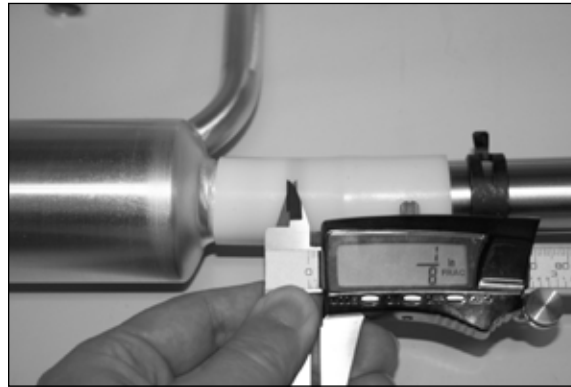

7. Slide the clamps over the coupler and canister and coupler and header. Note that clamp needs to be forward of the bump on the header to help hold the header in place from sliding out.

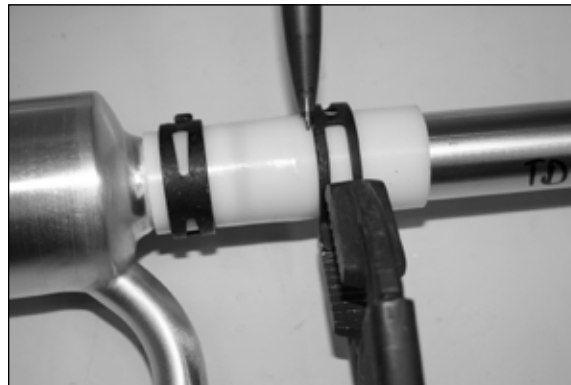

8. Complete the header/canister assembly as pictured below.



9. Slide the canisters inside the tunnel and into the mount. Mount the header using blue threadlock and gasket.

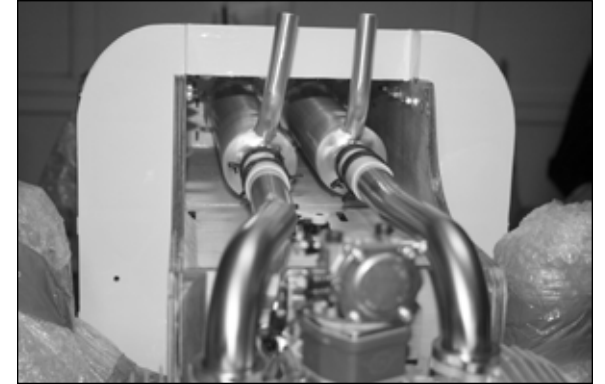

The picture below is of the tail end of the pipe tunnel.



## Tuned Pipe Installation

---

### Required Parts

Pipe mounts Silicone tubing

### Required Parts (not included)

MTW RE2 Pipe  
 50mm drop header, 11 1/2-inch for RE2 tuned pipe setup  
 Couplers Clamps

### Required Tools and Adhesives

Hobby knife	Felt-tipped pen
30-minute epoxy	Clamps
Vise grip	Iron
Ruler	100-grit sandpaper
Masking tape	Industrial lubricant
Acid brush	Mixing cup and sticks

1. Prepare the mount by passing the silicone tubing through the holes starting from the middle and finishing in the middle.

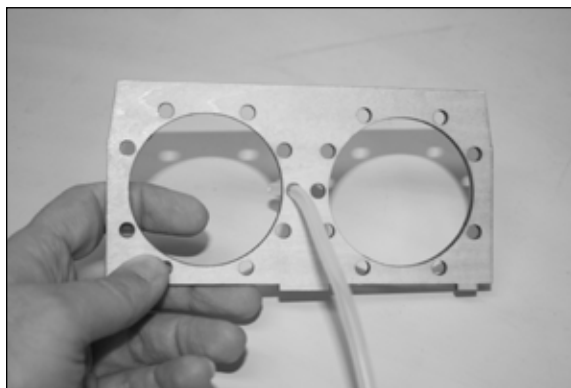

10. Cut and remove the bottom former of the cowl for canister exits using a rotary tool and cutting wheel.

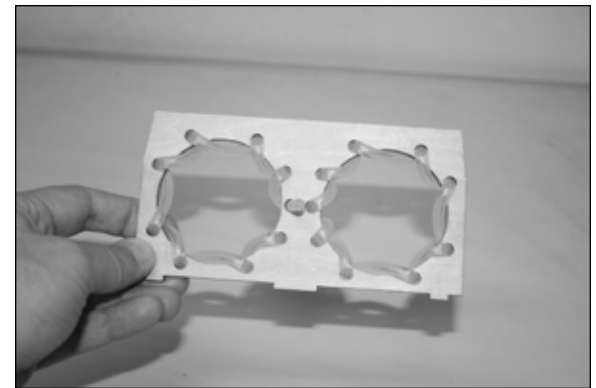

2. Apply 4 pieces of masking tape along the edges of the section needed to be opened for tuned pipe cooling.



3. Cut along the masking tape and remove the covering.



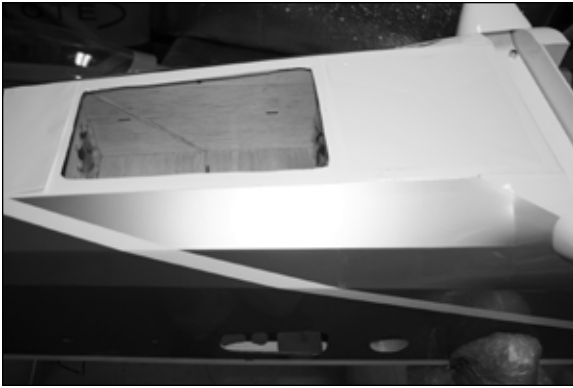

□ 4. Remove the balsa ramp.



□ 5. Iron down the edges and make sure to remove any excess covering that may catch air in-flight and lift up.

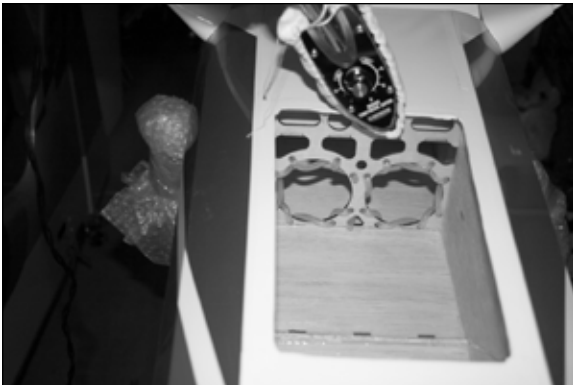

□ 6. Remove the covering from the aft opening. The picture below shows the two places where covering needs to be removed for tune pipe installation.



□ 7. Trial fit the mount before gluing to the fuselage. If it needs adjustment use 100-grit sandpaper and adjust for a snug fit.

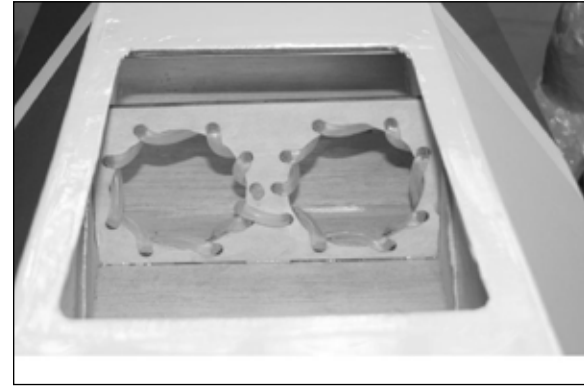

Note: Make sure that the sandpaper is on a flat surface and carefully remove a small amount until fit is perfect. Do not over sand the mount.

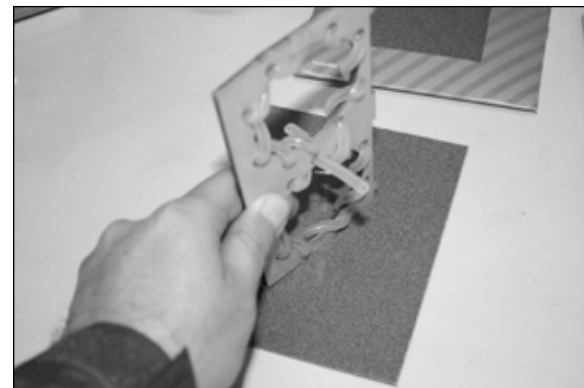

□ 8. Once satisfied with the fit of the mount in the fuselage, mix a small amount of 30-minute epoxy with mixing cup and sticks and apply to the mount using acid brush.

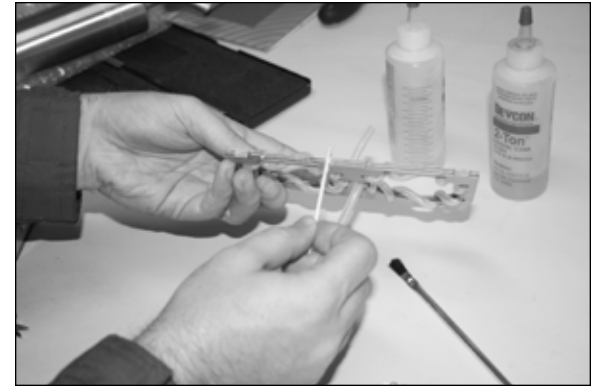

□ 9. Apply some epoxy to the fuselage where the mount interlocks and the walls where the mount touches.

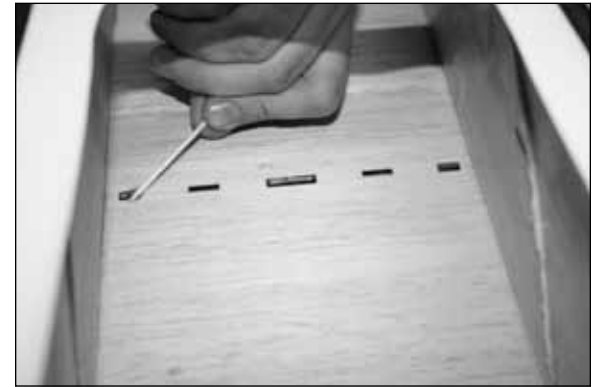

□ 10. Carefully glue the mount in place and wait until it is cured before installing the tuned pipes.

The picture below shows the mount installed.



□ 11. Recommended header length for MTW RE2 tuned pipe and DA120 is 11 1/2 inches . Assemble the pipe/header using a vice-grip. Open the clamps and slide them over the header.

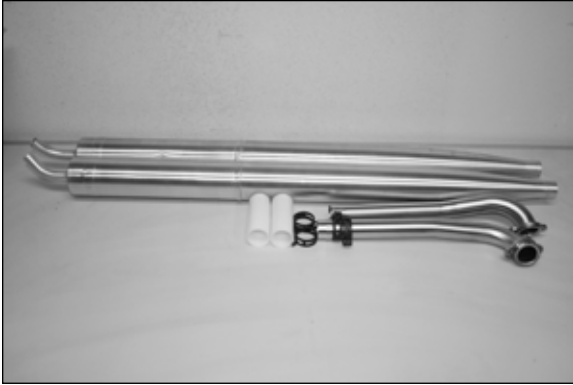

□ 12. Coupler fit on the header is tight. Use the working bench to lay one side of the coupler on and exert pressure from the other side by hand.

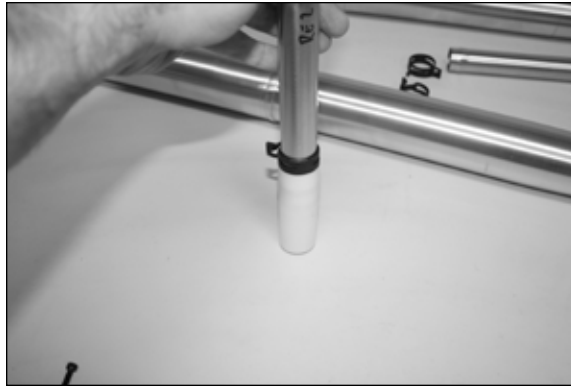

□ 13. Push the other side of coupler into the RE2 pipe and leave 1/8–1/4 inch gap between header and pipe.

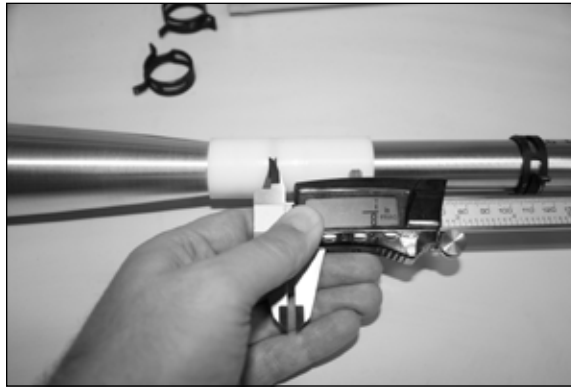

□ 14. Once satisfied with the gap, pull the clamps on and over the coupler and pipe. Then slide the other clamp on the pipe and header, such that is it forward the bump on the header.

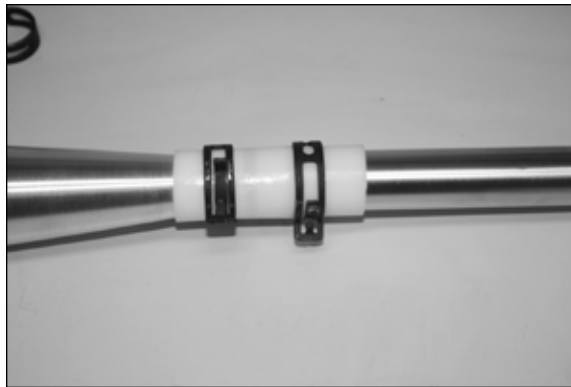

□ 15. Once everything is assembled, heat the couplers

where clamps are using a heat gun at high setting. Do this for a few minutes and allow some time for cooling. Repeat this one more time. This creates a good grip and reduces chance of pipe/header slipping out in flight. It is also recommended to do this before the first flight. Let engine idle for 3 to 4 minutes to warm up the couplers, gradually increasing the throttle to half to get the engine hot and then allow a cool-down period before the first flight. This should not need repeating and when done right, header/pipe will not slip out.

□ 16. Slide the pipes into the tunnel. Use lubricants over the pipes or the silicone mount for ease of installation.

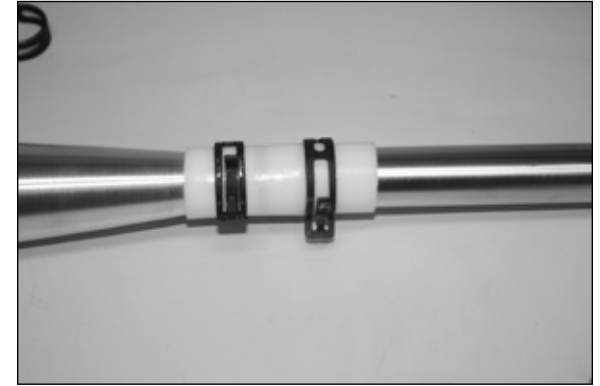

□ 17. Apply threadlock to header bolts and use DA gasket or high-temperature RTV and bolt the headers to the engine.



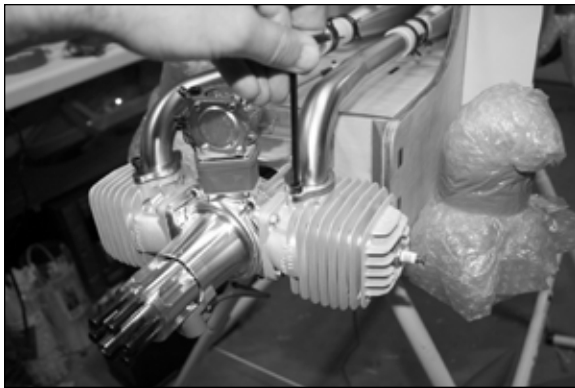

Picture of the aft end of the tuned pipes in the tunnel.



## Receiver and Ignition Battery Installation

### Required Parts

Fuselage

Hook and loop roll

### Required Parts (not included)

(2) 4000mAh 2-cell Spektrum Li-Po

(1) 2000mAh 2-cell Spektrum Li-Po

### Required Tools and Adhesives

Medium CA

Scissors

Adhesive-backed hook and loop

1. Cover the back of the batteries with pieces of masking tape as in the picture below.

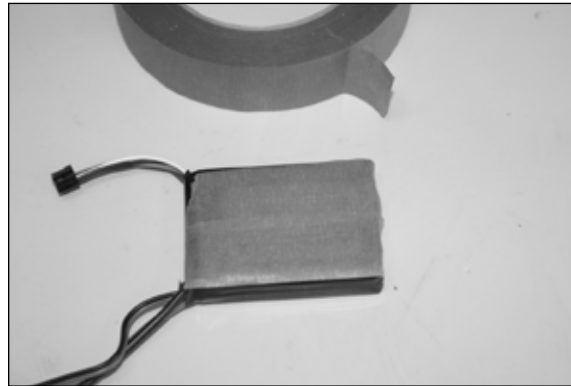

2. Apply some medium CA to the back of masking tape and glue a piece of hook and loop to the masking tape.

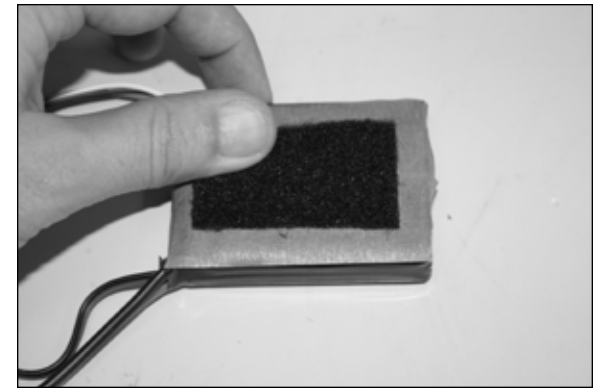

3. Cut 3 pieces of opposite side of the hook and loop that are glued to the batteries.

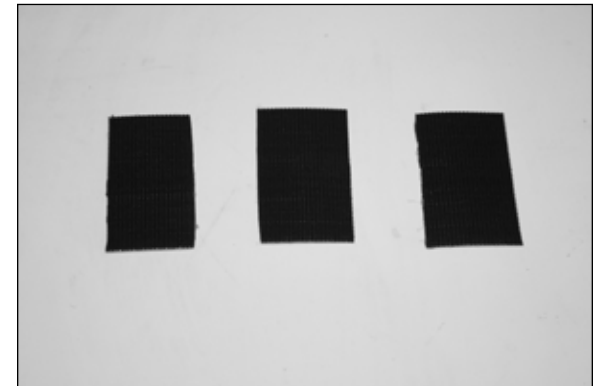

4. Using medium CA, glue the pieces of hook and loop to the fuselage in the allocated battery place.

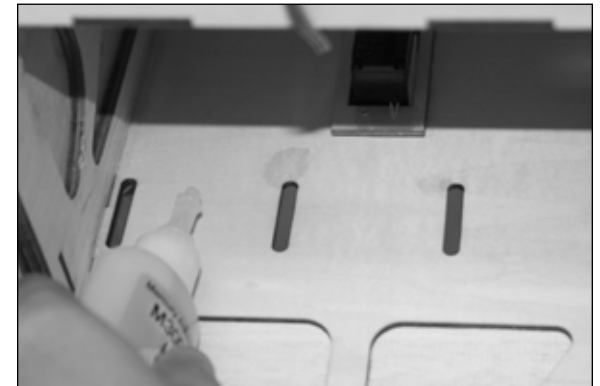

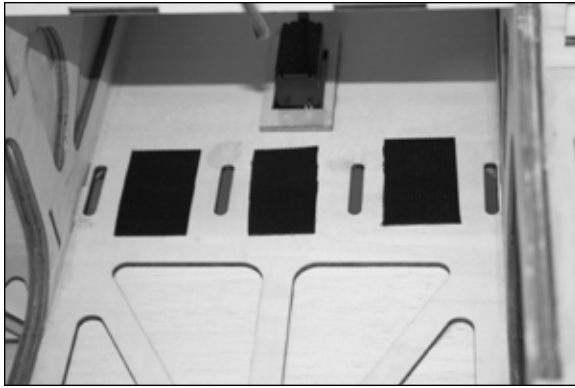

5. Cut 3 pieces of hook and loop from the roll provided in the kit.



6. Make sure CA is dry, mount the batteries and strap them in using the hook and loop. Receiver batteries are located at the sides and ignition battery in the middle.



## Ignition Module, Switch and Regulator Installation

### Required Parts

Fuselage

### Required Parts (not included)

JR 5203 regulator                      Ignition Module  
 JR heavy-duty switch or similar  
 JR heavy-duty 6-inch extension

### Required Tools and Adhesives

Medium CA                                  1/4-inch Du-Bro foam  
 Scissors  
 Adhesive-backed hook and loop

1. Apply some pieces of masking tape to the back of the ignition module.

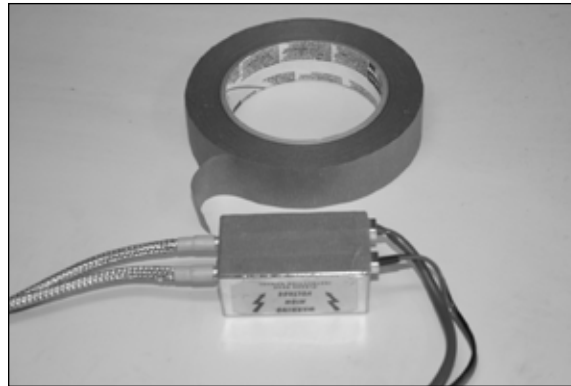

2. Apply some medium CA to the back of masking tape and glue a piece of foam to the masking tape.

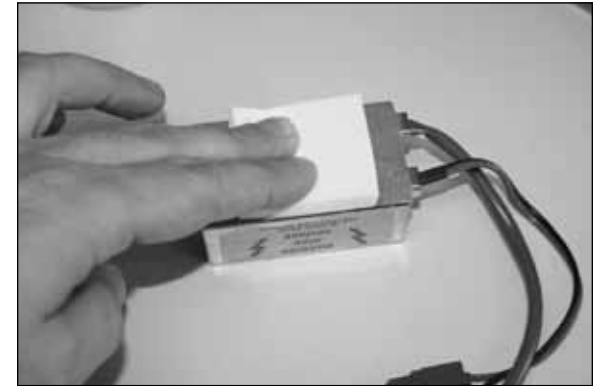
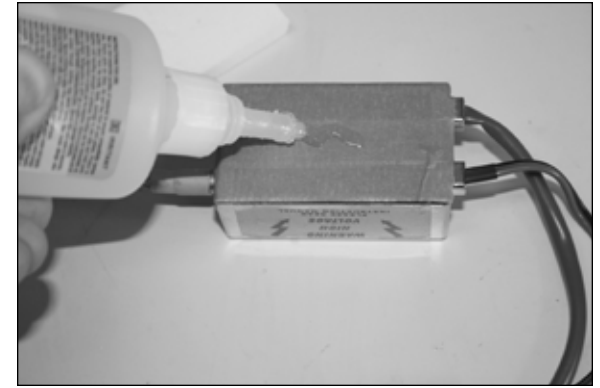

3. Glue a piece of hook and loop using medium CA.



4. Apply some medium CA to the engine box where the ignition module will be glued.

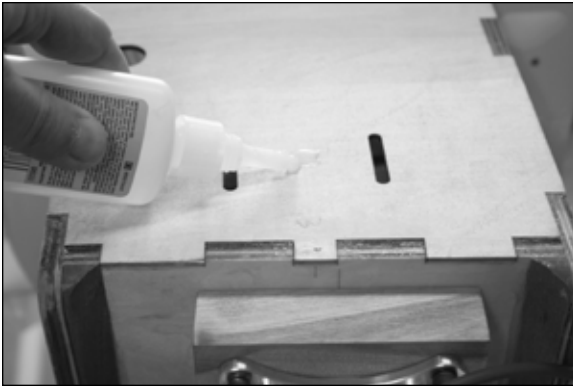

5. Cut the opposite side of hook and loop to the ignition module and glue to the engine box.

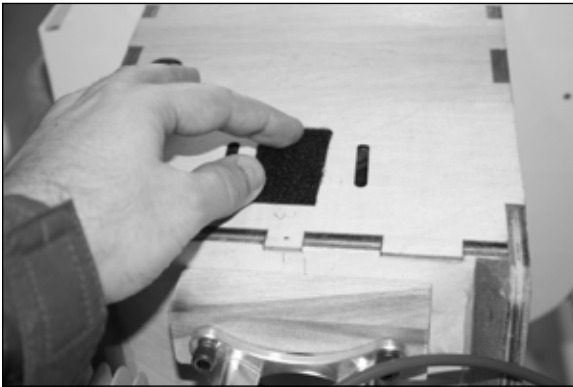

6. Cut a piece from the hook and loop roll provided in the kit and strap the ignition module in place.

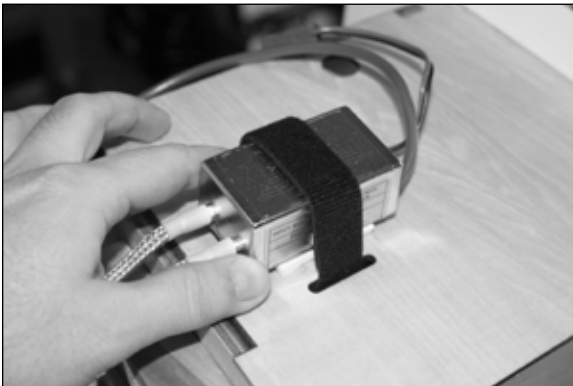

7. Apply a piece of masking tape to the bottom of the ignition regulator.

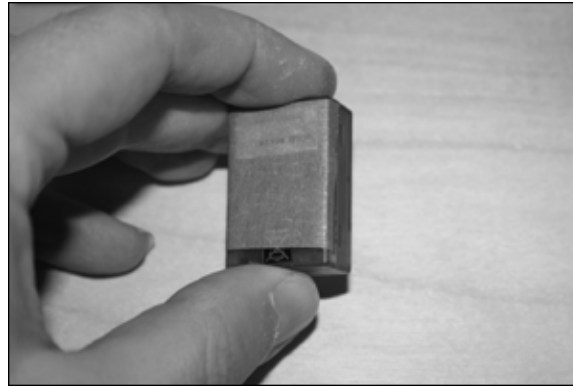

8. Glue a piece of industrial-strength hook and loop using medium CA to the back of the regulator over the masking tape.

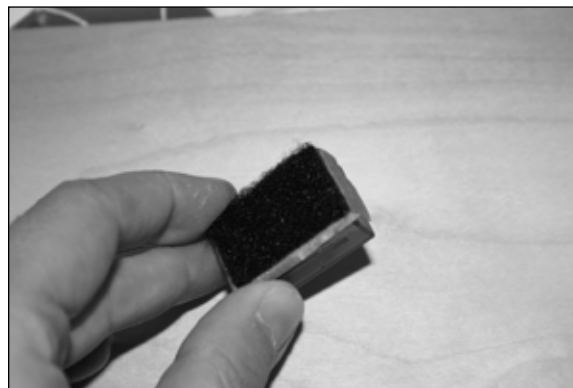
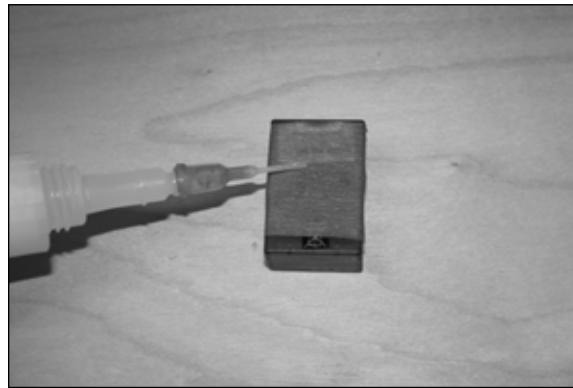

9. Apply some medium CA to the former where the ignition regulator will be mounted and glue the opposite side of the hook and loop.



10. Mount the regulator.



11. Ignition switch mount is already installed at the side of the fuselage. Remove the covering where the ignition switch will be mounted.

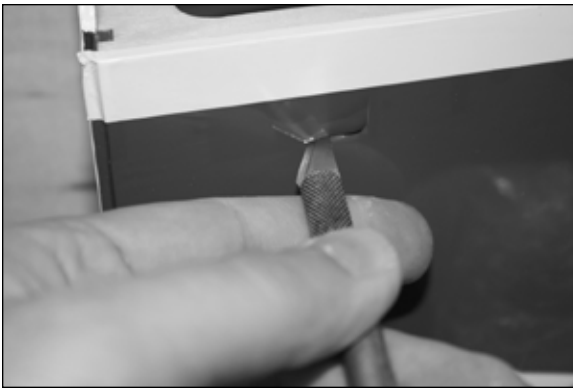

12. Mount the ignition switch.



Note: Connect battery to switch, output of the switch to regulator (6-inch extension is needed) and regulator output to ignition. With this method, you can charge the battery directly through the switch charge port.

## Fuel Tank, Fill and Over Flow Installation

### Required Parts

Fuselage                      Fuel tank

### Required Parts (not included)

Hangar 9 Fuel filler and T

### Required Tools and Adhesives

Drill and bits (1/16-inch, 1/8-inch, 1/4-inch)

Zip tie

Double-sided tape

Medium CA

Rotary tool

Sanding Drum (3/8-inch)

1/2-inch socket

1. Fuel tank comes assembled and installed. It is recommended that lines be checked every 2–3 months and replaced if they have hardened.

2. Fill line is installed at the front left side of the fuselage using Hangar 9 fuel filler. Drill a small hole; then using a rotary tool and 3/8-inch diameter sanding drum or grinding bit, open the side of the fuselage for the fuel filler.



The picture below shows the sanding drum next to the fuel filter housing.

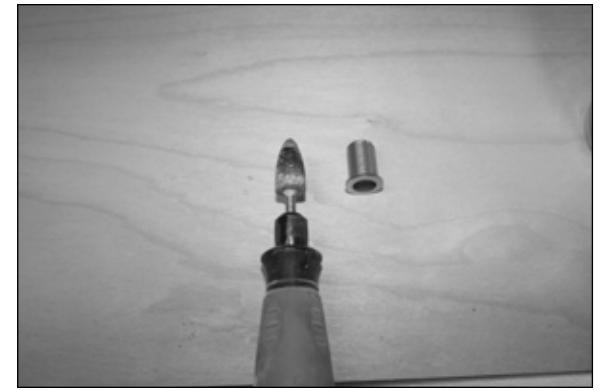

Using a rotary tool and the sanding drum, open up the hole. Base of the sanding drum is same size of the fuel filler housing diameter.



3. Apply some threadlock over the threads of the fuel filler housing and use a 1/2-inch socket to tighten the nut from inside the fuselage.



- 4. Drill a 1/8-inch hole in the bottom left side of the engine box. Then increase the hole by drilling a 1/4-inch hole. Do not use the 1/4-inch drill bit without doing a smaller hole or the wood can be cracked.



- 5. Loop the vent line behind the tank then forward and through the hole in the bottom of the motor box.

Note: Looping the vent line behind the tank will prevent gas from siphoning through the vent line in flights and will increase flight time.



- 6. Using commercially available cord clips, route the vent through the bottom of the engine box.

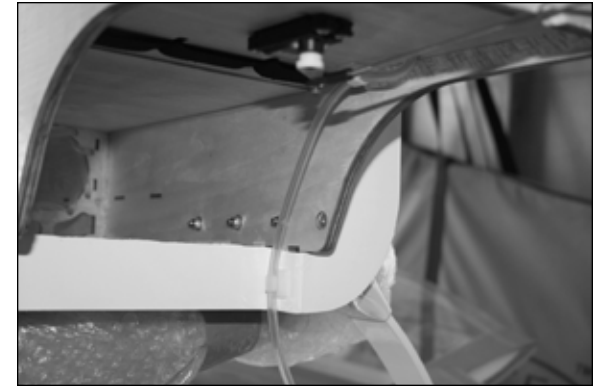
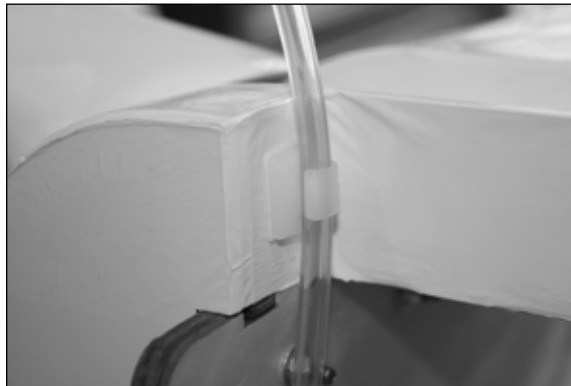

- 7. The fill line connects to the T-fitting in the fuel line.





## Cowl Mounting

### Required Parts

Cowl  
Fuselage  
(6) 4-40 screws, washers and lock washers

### Required Tools and Adhesives

3/32-inch ball driver

1. The cowl is secured at the top and the bottom. There are four 4-40 screws inserted through the inside of the fuselage. First the lock washer goes on the screw then the flat washer.

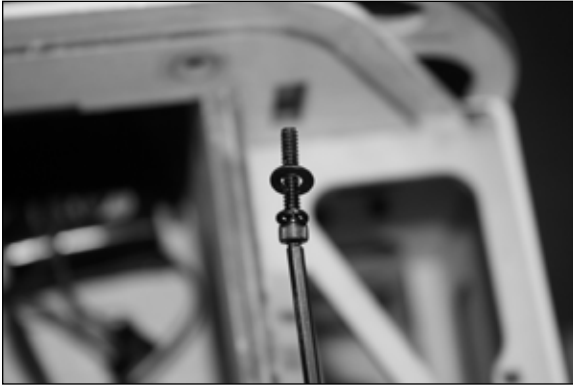

2. The bottom two 4-40 screws are inserted through the lower sides of the cowl.



## Pilot Installation

### Required Parts

Canopy  
Pilot

### Required Tools and Adhesives

3/32-inch ball driver  
Threadlock  
Alcohol swab  
Shoo Goo

1. Take the screws that hold the pilot head to the body out and apply threadlock to them and re-tighten.

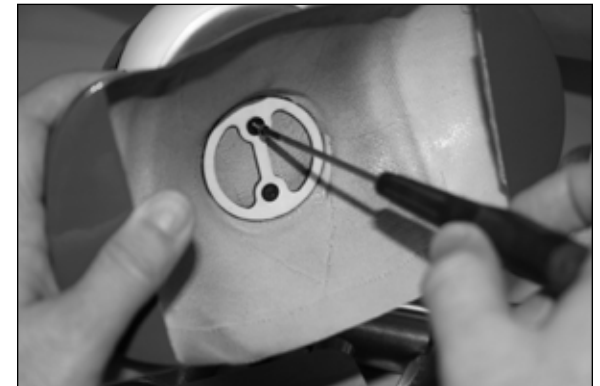

2. Lightly sand the underside of the shoulders to scuff the paint and clean the mounting shoulders of the pilot with alcohol swabs.

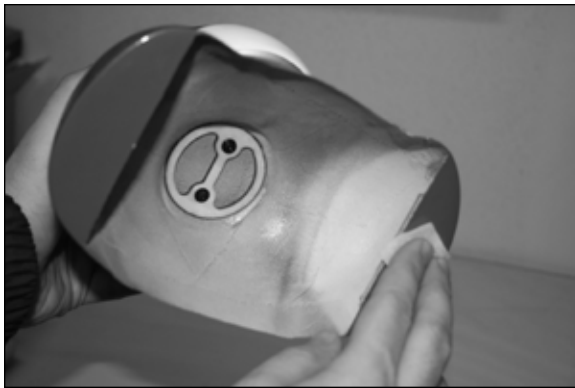

3. Apply Shoo Goo to the underside of the shoulders and the rear rail of the canopy.

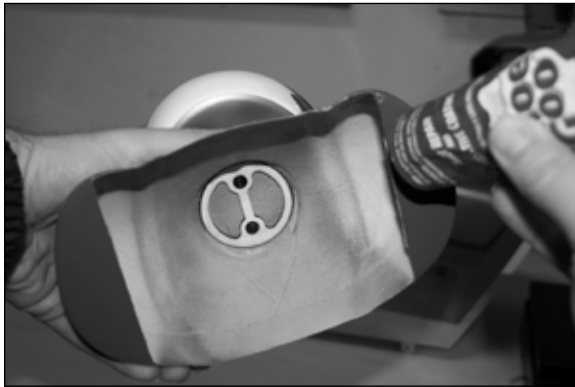

4. Mount the pilot. Apply some pressure and let the canopy sit on a flat surface until Shoo Goo cures.



5. The model comes with instrument panels. Cut the instrument panel decals to size and install on the front and rear dash boards in the cockpit.



The picture below shows the front pilot panel.

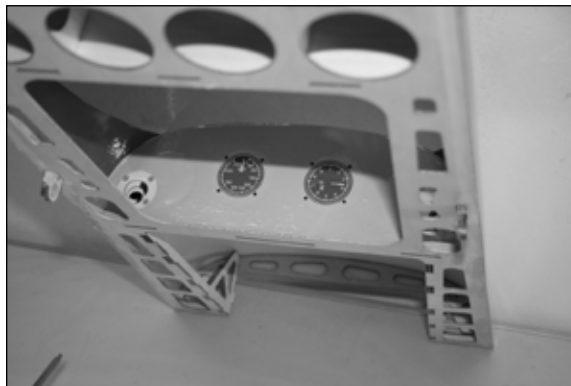

## Receiver, Switch and Throttle Servo Regulator Installation

### Required Parts

Fuselage

### Required Parts (not included)

JR 5203 regulator

AR9110 Receiver

### Required Tools and Adhesives

Masking tape

Medium CA

CA accelerator

Du-Bro 1/4-inch foam

Hook and loop

JR servo extension, 3-inch

1. Prepare the receiver to mount on the tray, similar to the ignition battery preparation in the previous section. Put two pieces of masking tape at the bottom of the receiver. Using CA glue 1/4-inch Du-Bro foam to the masking tape and glue a piece of hook and loop to the foam.



2. Glue opposite side of the hook and loop to the tray.



3. Mount the receiver and secure it with a piece of hook and loop strap.



4. Remove the covering to mount the soft switch. There are 3 different size switch mounts on each side of the fuselage.

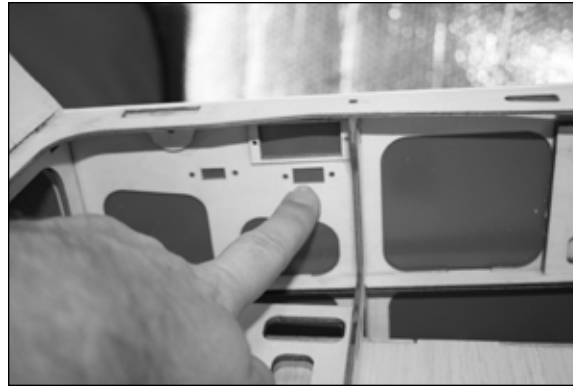

5. Apply a drop of threadlock on the switch mounting screws and mount the switch.



6. Throttle servo regulator is mounted next to the receiver using two pieces of hook and loop similar to receiver installation except it does not need foam.



7. Run a 24-inch servo extension from throttle servo to the regulator and a 3-inch extension from the regulator to the receiver unit.

## Satellite Receiver Installation

### Required Parts

Fuselage

### Required Parts (not included)

(3 to 4) Satellite receivers

### Required Tools and Adhesives

Double-sided tape

Masking tape

Hook and loop

Medium CA

Note: It is best to use 4 satellite receivers as this is a large model. However, with proper placement of the satellite receivers, 3 would be adequate. A Flight Log can help with correct placement of the satellite receivers. Check the health of the system before first flight.

□ 1. There are two ways to mount the satellite receivers. One way is to simply apply a piece of double-sided/servo tape to the back of the satellite receiver and attach to the fuselage. See step 3 for the alternative method.

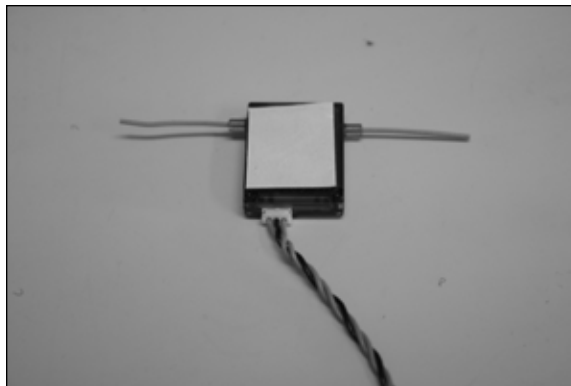
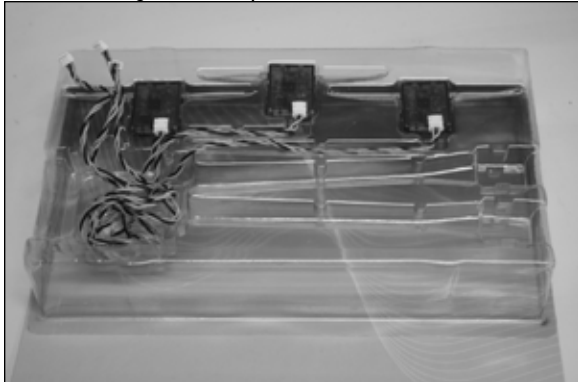

Location of Satellite receiver 1.



Location of Satellite receiver 2 - side of the fuselage tunnel.



Location of Satellite receiver3 - front of the tank and on the left vertical side.



Location of Satellite receiver 4 - front of the tank and on the right vertical side.



□ 2. Attach a piece of masking tape to the back of the satellite receiver; apply a couple of drops of CA to the masking tape and stick a piece of hook and loop to the masking tape. Note that even if the hook and loop is adhesive-backed, CA helps hold the hook and loop to the masking tape in high temperatures.

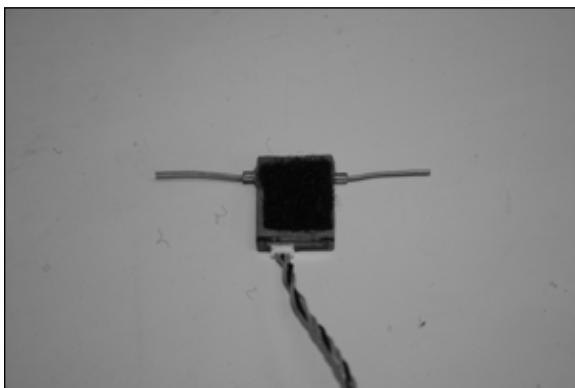

### Center of Gravity

An important part of preparing the aircraft for flight is properly balancing the model.

**⚠ CAUTION: Do not inadvertently skip this step!**

The recommended Center of Gravity (CG) location for your model is 4 inches to 4 3/4 inches (10.2cm 12cm) to back from the leading edge of the wing tip as shown. Mark the location of the CG on the top of the wing with a felt-tipped pen.

Use help to lift the plane from the marked position.

For precision and IMAC flying, 4 inches (10.2cm) is the best CG. For the best combination of strong 3D flying and a more sensitive yet precise feel, 4-3/4 inches (12.7cm) is recommended.

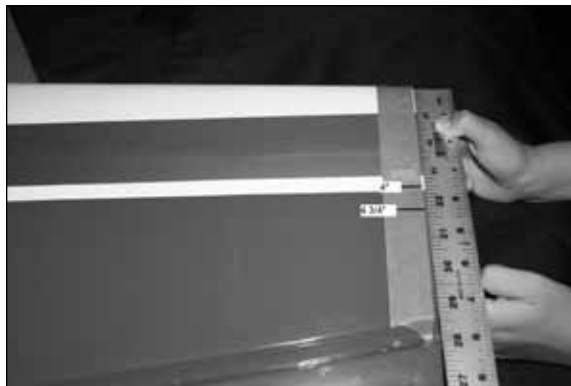

After the first flights, the CG position can be adjusted for your personal preference.

### Control Throws

- 1. Turn on the transmitter and receiver of your model. Check the movement of the rudder using the transmitter. When the stick is moved right, the rudder should also move right. Reverse the direction of the servo at the transmitter if necessary.
- 2. Check the movement of the elevator with the radio system. Moving the elevator stick toward the bottom of the transmitter will make the airplane elevator move up.
- 3. Check the movement of the ailerons with the radio system. Moving the aileron stick right will make the right aileron move up and the left aileron move down.
- 4. Use a throw meter to adjust the throw of the elevator, ailerons and rudder.

Mike McConville has three flight modes as follows:

1. Normal: This flight mode is used for most precision maneuvers.
2. Fast Roll: This flight mode is for aggressive yet precise aerobatics such as very fast rolling loops, hammers, or maneuvers needing strong knife edge. It has high-rate aileron and rudder and low-rate elevator.
3. High (3D): All surfaces at full deflection for 3D flying.

Mike's Extra 300 is balanced at the 4-3/4" CG location.

His setup uses a slight down elevator to throttle mix at very low throttle stick position for down lines. 6% up elevator to rudder and 3% opposite aileron to rudder mixing to eliminate

slight coupling in knife edge.  
Please note this is very CG dependant.

#### Elevator:

<i>High Rate:</i>		<i>Expo</i>
Up:	50 degrees	70%
Down:	50 degrees	70%

<i>Normal:</i>		<i>Expo</i>
Up:	12 degrees	40%
Down:	11 degrees	40%

#### Aileron:

<i>High Rate:</i>		<i>Expo</i>
Up:	40 degrees	50%
Down:	40 degrees	50%

<i>Normal Rate:</i>		<i>Expo</i>
Up:	24 degrees	35%
Down:	24 degrees	35%

#### Rudder:

<i>High:</i>		<i>Expo</i>
Right:	45 degrees	45%
Left:	45 degrees	45%

<i>Normal Rate:</i>		
Right:	27 degrees	40%
Left:	27 degrees	40%

These are general guidelines measured from our own flight tests. You can experiment with different rates to match your preferred style of flying.

If using the Spektrum DX-8, Mike's personal setup can be downloaded from the Spektrum Community website at: <https://community.spektrumrc.com/>.

## Applying Decals

The model comes with decal sets and all decals are die-cut. All large decals should be applied wet so the bubbles can be worked out by squeegee. Allow 24 hours for decals to dry and adhesive to set.

It is important to take all the wrinkles in the covering out and would be best to apply the decals after the plane has been taken to a flying field a couple of times and all the wrinkles have been removed. The following pictures show the location of decals.

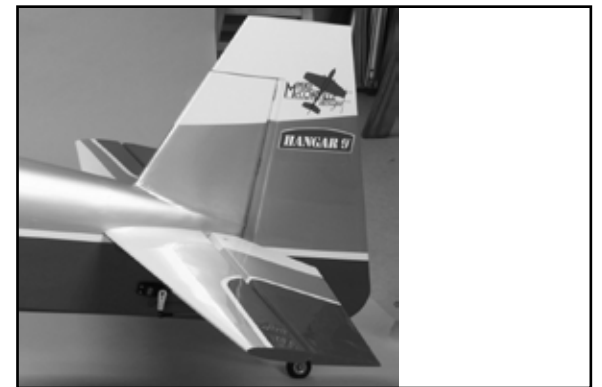
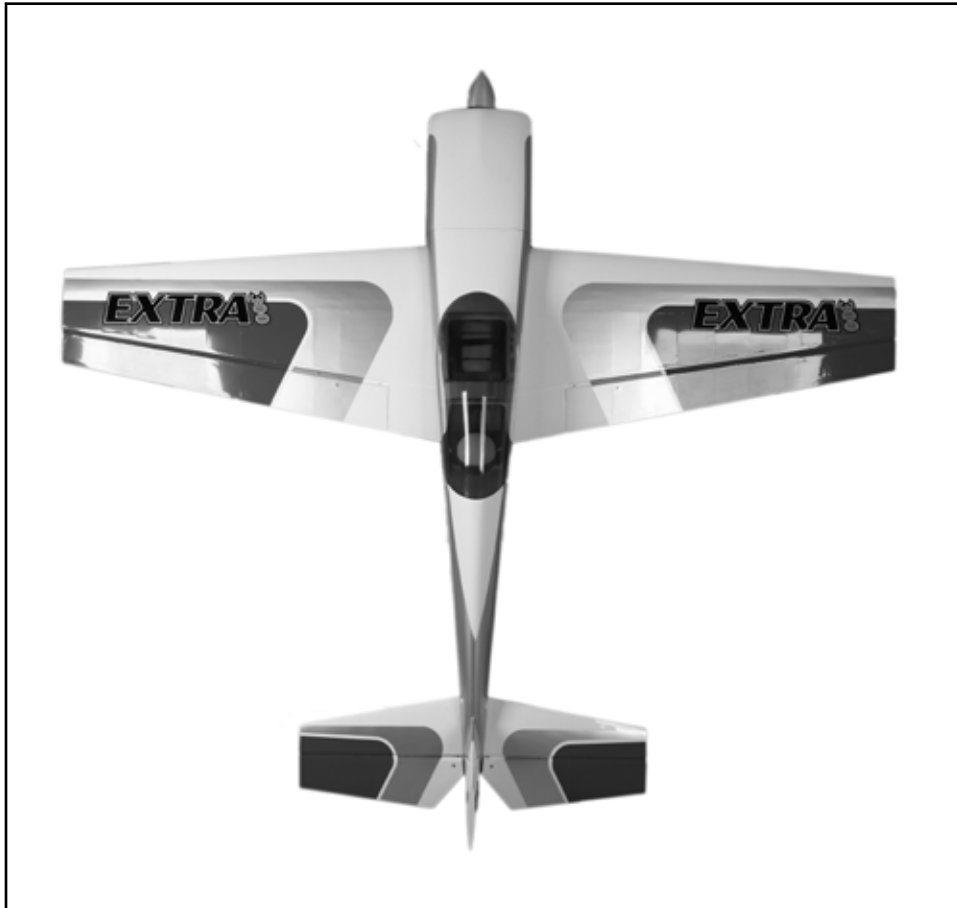

## ***Preflight***

---

### **Check Your Radio**

Before going to the field, be sure your batteries are fully charged per your radio's instructions. Charge the transmitter and motor battery for your airplane. Use the recommended charger supplied with your particular radio system, following the instructions provided with the radio. In most cases, the radio should be charged the night before going out flying.

Before each flying session, be sure to range check your radio. See your radio manual for the recommended range and instructions for your radio system. Each radio manufacturer specifies different procedures for their radio systems. Next, run the motor. With the model securely anchored, check the range again. The range test should not be significantly affected. If it is, don't attempt to fly! Have your radio equipment checked out by the manufacturer.

Double-check that all controls (aileron, elevator, rudder and throttle) move in the correct direction.

Check the radio installation and make sure all the control surfaces are moving correctly (i.e., the correct direction and with the recommended throws).

Check all the control horns, servo horns, and clevises to make sure they are secure and in good condition.

### ***Range Test Your Radio***

---

Before each flying session, and especially with a new model, it is important to perform a range check. It is helpful to have another person available to assist during the range check. If you are using a Spektrum transmitter, please refer to your transmitter's manual for detailed instructions on the range check process.

## ***Safety Do's and Don'ts for Pilots***

---

- Check all control surfaces prior to each takeoff.
- Do not fly your model near spectators, parking areas or any other area that could result in injury to people or damage of property.
- Do not fly during adverse weather conditions. Poor visibility can cause disorientation and loss of control of your aircraft. Strong winds can cause similar problems.
- Do not take chances. If at any time during flight you observe any erratic or abnormal operation, land immediately and do not resume flight until the cause of the problem has been ascertained and corrected. Safety can never be taken lightly.
- Do not fly near power lines.

### ***Daily Flight Checks***

---

- 1. Check the battery voltage of the transmitter battery. Do not fly below the manufacturer's recommended voltage. To do so can crash your aircraft.

**When you check these batteries, ensure you have the polarities correct on your expanded scale voltmeter.**

- 2. Check all hardware (linkages, screws, nuts, and bolts) prior to each day's flight. Be sure that binding does not occur and that all parts are properly secured.
- 3. Ensure all surfaces are moving in the proper manner.
- 4. Perform a ground range check before each day's flying session.
- 5. Prior to starting your aircraft, turn off your transmitter, then turn it back on. Do this each time you start your aircraft. If any critical switches are on without your knowledge, the transmitter alarm will sound a warning at this time.
- 6. Check that all trim levers are in the proper location.
- 7. All servo pigtails and switch harness plugs should be secured in the receiver. Make sure the switch harness moves freely in both directions.

## LIMITED WARRANTY

---

### WHAT THIS WARRANTY COVERS

---

Horizon Hobby, Inc. (“Horizon”) warrants to the original purchaser that the product purchased (the “Product”) will be free from defects in materials and workmanship at the date of purchase.

### WHAT IS NOT COVERED

---

This warranty is not transferable and does not cover (i) cosmetic damage, (ii) damage due to acts of God, accident, misuse, abuse, negligence, commercial use, or due to improper use, installation, operation or maintenance, (iii) modification of or to any part of the Product, (iv) attempted service by anyone other than a Horizon Hobby authorized service center, or (v) Products not purchased from an authorized Horizon dealer.

OTHER THAN THE EXPRESS WARRANTY ABOVE, HORIZON MAKES NO OTHER WARRANTY OR REPRESENTATION, AND HEREBY DISCLAIMS ANY AND ALL IMPLIED WARRANTIES, INCLUDING, WITHOUT LIMITATION, THE IMPLIED WARRANTIES OF NON-INFRINGEMENT, MERCHANTABILITY AND FITNESS FOR A PARTICULAR PURPOSE. THE PURCHASER ACKNOWLEDGES THAT THEY ALONE HAVE DETERMINED THAT THE PRODUCT WILL SUITABLY MEET THE REQUIREMENTS OF THE PURCHASER’S INTENDED USE.

### PURCHASER’S REMEDY

---

Horizon’s sole obligation and purchaser’s sole and exclusive remedy shall be that Horizon will, at its option, either (i) service, or (ii) replace, any Product determined by Horizon to be defective. Horizon reserves the right to inspect any and all Product(s) involved in a warranty claim. Service or replacement decisions are at the sole discretion of Horizon. Proof of purchase is required for all warranty claims. SERVICE OR REPLACEMENT AS PROVIDED UNDER THIS WARRANTY IS THE PURCHASER’S SOLE AND EXCLUSIVE REMEDY.

### LIMITATION OF LIABILITY

---

HORIZON SHALL NOT BE LIABLE FOR SPECIAL, INDIRECT, INCIDENTAL OR CONSEQUENTIAL DAMAGES, LOSS OF PROFITS OR PRODUCTION OR COMMERCIAL LOSS IN ANY

WAY, REGARDLESS OF WHETHER SUCH CLAIM IS BASED IN CONTRACT, WARRANTY, TORT, NEGLIGENCE, STRICT LIABILITY OR ANY OTHER THEORY OF LIABILITY, EVEN IF HORIZON HAS BEEN ADVISED OF THE POSSIBILITY OF SUCH DAMAGES. Further, in no event shall the liability of Horizon exceed the individual price of the Product on which liability is asserted. As Horizon has no control over use, setup, final assembly, modification or misuse, no liability shall be assumed nor accepted for any resulting damage or injury. By the act of use, setup or assembly, the user accepts all resulting liability. If you as the purchaser or user are not prepared to accept the liability associated with the use of the Product, purchaser is advised to return the Product immediately in new and unused condition to the place of purchase.

### LAW

---

These terms are governed by Illinois law (without regard to conflict of law principals). This warranty gives you specific legal rights, and you may also have other rights which vary from state to state. Horizon reserves the right to change or modify this warranty at any time without notice.

### WARRANTY SERVICES

---

#### Questions, Assistance, and Services

Your local hobby store and/or place of purchase cannot provide warranty support or service. Once assembly, setup or use of the Product has been started, you must contact Horizon directly. This will enable Horizon to better answer your questions and service you in the event that you may need any assistance. For questions or assistance, please direct your email to [productsupport@horizonhobby.com](mailto:productsupport@horizonhobby.com), or call 877.504.0233 toll free to speak to a Product Support representative. You may also find information on our website at [www.horizonhobby.com](http://www.horizonhobby.com).

### INSPECTION OR SERVICES

---

If this Product needs to be inspected or serviced, please use the Horizon Online Service Request submission process found on our website or call Horizon to obtain a Return Merchandise Authorization (RMA) number. Pack the Product securely using a shipping carton. Please note that original

boxes may be included, but are not designed to withstand the rigors of shipping without additional protection. Ship via a carrier that provides tracking and insurance for lost or damaged parcels, as Horizon is not responsible for merchandise until it arrives and is accepted at our facility. An Online Service Request is available at <http://www.horizonhobby.com> under the Support tab. If you do not have internet access, please contact Horizon Product Support to obtain a RMA number along with instructions for submitting your product for service. When calling Horizon, you will be asked to provide your complete name, street address, email address and phone number where you can be reached during business hours. When sending product into Horizon, please include your RMA number, a list of the included items, and a brief summary of the problem. A copy of your original sales receipt must be included for warranty consideration. Be sure your name, address, and RMA number are clearly written on the outside of the shipping carton.

**Notice: Do not ship LiPo batteries to Horizon. If you have any issue with a LiPo battery, please contact the appropriate Horizon Product Support office.**

### WARRANTY REQUIREMENTS

---

**For Warranty consideration, you must include your original sales receipt verifying the proof-of-purchase date.** Provided warranty conditions have been met, your Product will be serviced or replaced free of charge. Service or replacement decisions are at the sole discretion of Horizon.

### NON-WARRANTY SERVICE

---

**Should your service not be covered by warranty service will be completed and payment will be required without notification or estimate of the expense unless the expense exceeds 50% of the retail purchase cost.** By submitting the item for service you are agreeing to payment of the service without notification. Service estimates are available upon request. You must include this request with your item submitted for service. Non-warranty service estimates will be billed a minimum of ½ hour of labor. In addition you will be billed for return freight. Horizon accepts money orders and cashiers checks, as well as Visa, MasterCard, American Express, and Discover cards. By submitting any item to Horizon for service, you are agreeing to Horizon’s Terms and Conditions found on our website <http://www.horizonhobby.com/Service/Request/>.



**United States:**

Electronics and engines requiring inspection or repair should be shipped to the following address:

Horizon Service Center  
4105 Fieldstone Road  
Champaign, Illinois 61822  
USA

Online Repair Request visit:  
[www.horizonhobby.com/repairs](http://www.horizonhobby.com/repairs)

All other Products requiring warranty inspection or repair should be shipped to the following address:

Horizon Product Support  
4105 Fieldstone Road  
Champaign, Illinois 61822  
USA

Please call 877-504-0233 or e-mail us at [productsupport@horizonhobby.com](mailto:productsupport@horizonhobby.com) with any questions or concerns regarding this product or warranty.

**United Kingdom:**

Electronics and engines requiring inspection or repair should be shipped to the following address:

Horizon Hobby Limited  
Units 1-4 Ployters Rd  
Staple Tye  
Harlow, Essex  
CM18 7NS  
United Kingdom

Please call +44 (0) 1279 641 097 or e-mail us at [sales@horizonhobby.co.uk](mailto:sales@horizonhobby.co.uk) with any questions or concerns regarding this product or warranty.

**Germany:**

Electronics and engines requiring inspection or repair should be shipped to the following address:

Horizon Technischer Service  
Hamburger Strasse 10  
25335 Elmshorn  
Germany

Please call +49 4121 46199 66 or e-mail us at [service@horizonhobby.de](mailto:service@horizonhobby.de) with any questions or concerns regarding this product or warranty.

**France:**

Horizon Hobby SAS  
14 Rue Gustave Eiffel  
Zone d'Activité du  
Réveil Matin  
91230 Montgeron

Please call +33 (0) 1 60 47 44 70 with any questions or concerns regarding this product or warranty.

[infofrance@horizonhobby.com](mailto:infofrance@horizonhobby.com)

**Compliance Information for the  
European Union**



**INSTRUCTIONS FOR DISPOSAL OF WEEE BY  
USERS IN THE EUROPEAN UNION**

This product must not be disposed of with other waste. Instead, it is the user's responsibility to dispose of their waste equipment by handing it over to a designated collection point for the recycling of waste electrical and electronic equipment. The separate collection and recycling of your waste equipment at the time of disposal will help to conserve natural resources and ensure that it is recycled in a manner that protects human health and the environment. For more information about where you can drop off your waste equipment for recycling, please contact your local city office, your household waste disposal service or where you purchased the product.

# 2011 Official Academy of Model Aeronautics Safety Code

Effective January 1, 2011

**A. GENERAL:** A model aircraft is a non-human-carrying aircraft capable of sustained flight in the atmosphere. It may not exceed limitations of this code and is intended exclusively for sport, recreation and/or competition. All model flights must be conducted in accordance with this safety code and any additional rules specific to the flying site.

1. Model aircraft will not be flown:

(a) In a careless or reckless manner.

(b) At a location where model aircraft activities are prohibited.

2. Model aircraft pilots will:

(a) Yield the right of way to all man carrying aircraft.

(b) See and avoid all aircraft and a spotter must be used when appropriate. (AMA Document #540-D-See and Avoid Guidance.)

(c) Not fly higher than approximately 400 feet above ground level within three (3) miles of an airport, without notifying the airport operator.

(d) Not interfere with operations and traffic patterns at any airport, heliport or seaplane base except where there is a mixed use agreement.

(e) Not exceed a takeoff weight, including fuel, of 55 pounds unless in compliance with the AMA Large Model Aircraft program. (AMA Document 520-A)

(f) Ensure the aircraft is identified with the name and address or AMA number of the owner on the inside or affixed to the outside of the model aircraft.

(This does not apply to model aircraft flown indoors).

(g) Not operate aircraft with metal-blade propellers or with gaseous boosts except for helicopters operated under the provisions of AMA Document #555.

(h) Not operate model aircraft while under the influence of alcohol or while using any drug which could adversely affect the pilot's ability to safely control

the model.

(i) Not operate model aircraft carrying pyrotechnic devices which explode or burn, or any device which propels a projectile or drops any object that

creates a hazard to persons or property.

Exceptions:

Free Flight fuses or devices that burn producing smoke and are securely attached to the model aircraft during flight.

Rocket motors (using solid propellant) up to a G-series size may be used provided they remain attached to the model during flight. Model rockets

may be flown in accordance with the National Model Rocketry Safety Code but may not be launched from model aircraft.

Officially designated AMA Air Show Teams (AST) are authorized to use devices and practices as defined within the Team AMA Program

Document (AMA Document #718).

(j) Not operate a turbine-powered aircraft, unless in compliance with the AMA turbine regulations. (AMA Document #510-A).

3. Model aircraft will not be flown in AMA sanctioned events, air shows or model demonstrations unless:

(a) The aircraft, control system and pilot skills have successfully demonstrated all maneuvers intended or anticipated prior to the specific event.

(b) An inexperienced pilot is assisted by an experienced pilot.

4. When and where required by rule, helmets must be properly worn and fastened. They must be OSHA, DOT, ANSI, SNELL or NOCSAE approved or

comply with comparable standards.

## B. RADIO CONTROL (RC)

1. All pilots shall avoid flying directly over unprotected people, vessels, vehicles or structures and shall avoid t.

2. A successful radio equipment ground-range check in accordance with manufacturer's recommendations will be completed before the first flight of a new or

repaired model aircraft.

3. At all flying sites a safety line(s) must be established in front of which all flying takes place (AMA Document #706-Recommended Field Layout):

(a) Only personnel associated with flying the model aircraft are allowed at or in front of the safety line.

(b) At air shows or demonstrations, a straight safety line must be established.

(c) An area away from the safety line must be maintained for spectators.

(d) Intentional flying behind the safety line is prohibited.

4. RC model aircraft must use the radio-control frequencies currently allowed by the Federal Communications Commission (FCC). Only individuals properly

licensed by the FCC are authorized to operate equipment on Amateur Band frequencies.

5. RC model aircraft will not operate within three (3) miles of any pre-existing flying site without a frequency-management agreement (AMA Documents #922-

Testing for RF Interference; #923- Frequency Management Agreement)

6. With the exception of events flown under official AMA Competition Regulations, excluding takeoff and landing, no powered model may be flown outdoors

closer than 25 feet to any individual, except for the pilot and the pilot's helper(s) located at the flight line.

7. Under no circumstances may a pilot or other person touch a model aircraft in flight while it is still under power, except to divert it from striking an individual.

This does not apply to model aircraft flown indoors.

8. RC night flying requires a lighting system providing the pilot with a clear view of the model's attitude and orientation at all times.

9. The pilot of a RC model aircraft shall:

(a) Maintain control during the entire flight, maintaining visual contact without enhancement other than by corrective lenses prescribed for the pilot.

(b) Fly using the assistance of a camera or First-Person View (FPV) only in accordance with the procedures outlined in AMA Document #550.

## C. FREE FLIGHT

1. Must be at least 100 feet downwind of spectators and automobile parking when the model aircraft is launched.

2. Launch area must be clear of all individuals except mechanics, officials, and other fliers.

3. An effective device will be used to extinguish any fuse on the model aircraft after the fuse has completed its function.

## D. CONTROL LINE

1. The complete control system (including the safety thong where applicable) must have an inspection and pull test prior to flying.

2. The pull test will be in accordance with the current Competition Regulations for the applicable model aircraft category.

3. Model aircraft not fitting a specific category shall use those pull-test requirements as indicated for Control Line Precision Aerobatics.

4. The flying area must be clear of all utility wires or poles and a model aircraft will not be flown closer than 50 feet to any above-ground electric utility lines.

5. The flying area must be clear of all nonessential participants and spectators before the engine is started.



*Hangar 9, UltraCote and MatchBox are trademarks or registered trademarks of Horizon Hobby, Inc.*

*JR is a trademark of Horizon Hobby, Inc., registered in the U.S.*

*The Spektrum trademark is used with permission of Bachmann Industries, Inc.*



© 2011 Horizon Hobby, Inc.  
horizonhobby.com  
Hangar9.com