

# TRAIL PROVEN OFF-ROAD PERFORMANCE

# SCX10™

**SCX10™ II 1969 CHEVROLET BLAZER**

1/10th SCALE ELECTRIC 4WD - READY-TO-RUN



 **axial**®

[www.axialracing.com](http://www.axialracing.com)



## **AXIAL BUMPER TO BUMPER ONE (1) YEAR LIMITED WARRANTY**

### **LIMITED WARRANTY**

#### **What this Warranty Covers**

Horizon Hobby, LLC, (Horizon) warrants to the original purchaser that the product purchased (the "Product") will be free from defects in materials and workmanship at the date of purchase.

#### **What is Not Covered**

This warranty is not transferable and does not cover (i) cosmetic damage, (ii) damage due to acts of God, accident, misuse, abuse, negligence, commercial use, or due to improper use, installation, operation or maintenance, (iii) modification of or to any part of the Product, (iv) attempted service by anyone other than a Horizon Hobby authorized service center, (v) Product not purchased from an authorized Horizon dealer, (vi) Product not compliant with applicable technical regulations, or (vii) use that violates any applicable laws, rules, or regulations.

OTHER THAN THE EXPRESS WARRANTY ABOVE, HORIZON MAKES NO OTHER WARRANTY OR REPRESENTATION, AND HEREBY DISCLAIMS ANY AND ALL IMPLIED WARRANTIES, INCLUDING, WITHOUT LIMITATION, THE IMPLIED WARRANTIES OF NON-INFRINGEMENT, MERCHANTABILITY AND FITNESS FOR A PARTICULAR PURPOSE. THE PURCHASER ACKNOWLEDGES THAT THEY ALONE HAVE DETERMINED THAT THE PRODUCT WILL SUITABLY MEET THE REQUIREMENTS OF THE PURCHASER'S INTENDED USE.

#### **Purchaser's Remedy**

Horizon's sole obligation and purchaser's sole and exclusive remedy shall be that Horizon will, at its option, either (i) service, or (ii) replace, any Product determined by Horizon to be defective. Horizon reserves the right to inspect any and all Product(s) involved in a warranty claim. Service or replacement decisions are at the sole discretion of Horizon. Proof of purchase is required for all warranty claims. SERVICE OR REPLACEMENT AS PROVIDED UNDER THIS WARRANTY IS THE PURCHASER'S SOLE AND EXCLUSIVE REMEDY.

#### **Limitation of Liability**

HORIZON SHALL NOT BE LIABLE FOR SPECIAL, INDIRECT, INCIDENTAL OR CONSEQUENTIAL DAMAGES, LOSS OF PROFITS OR PRODUCTION OR COMMERCIAL LOSS IN ANY WAY, REGARDLESS OF WHETHER SUCH CLAIM IS BASED IN CONTRACT, WARRANTY, TORT, NEGLIGENCE, STRICT LIABILITY OR ANY OTHER THEORY OF LIABILITY, EVEN IF HORIZON HAS BEEN ADVISED OF THE POSSIBILITY OF SUCH DAMAGES. Further, in no event shall the liability of Horizon exceed the individual price of the Product on which liability is asserted. As Horizon has no control over use, setup, final assembly, modification or misuse, no liability shall be assumed nor accepted for any resulting damage or injury. By the act of use, setup or assembly, the user accepts all resulting liability. If you as the purchaser or user are not prepared to accept the liability associated with the use of the Product, purchaser is advised to return the Product immediately in new and unused condition to the place of purchase.

#### **Law**

These terms are governed by Illinois law (without regard to conflict of law principals). This warranty gives you specific legal rights, and you may also have other rights which vary from state to state. Horizon reserves the right to change or modify this warranty at any time without notice.

## WARRANTY SERVICES

### Questions, Assistance, and Services

Your local hobby store and/or place of purchase cannot provide warranty support or service. Once assembly, setup or use of the Product has been started, you must contact your local distributor or Horizon directly. This will enable Horizon to better answer your questions and service you in the event that you may need any assistance. For questions or assistance, please visit our website at [www.horizonhobby.com](http://www.horizonhobby.com), submit a Product Support Inquiry, or call the toll free telephone number referenced in the Warranty and Service Contact Information section to speak with a Product Support representative.

### Inspection or Services

If this Product needs to be inspected or serviced and is compliant in the country you live and use the Product in, please use the Horizon Online Service Request submission process found on our website or call Horizon to obtain a Return Merchandise Authorization (RMA) number. Pack the Product securely using a shipping carton. Please note that original boxes may be included, but are not designed to withstand the rigors of shipping without additional protection. Ship via a carrier that provides tracking and insurance for lost or damaged parcels, as Horizon is not responsible for merchandise until it arrives and is accepted at our facility. An Online Service Request is available at [http://www.horizonhobby.com/content/\\_service-center\\_render-service-center](http://www.horizonhobby.com/content/_service-center_render-service-center). If you do not have internet access, please contact Horizon Product Support to obtain a RMA number along with instructions for submitting your product for service. When calling Horizon, you will be asked to provide your complete name, street address, email address and phone number where you can be reached during business hours. When sending product into Horizon, please include your RMA number, a list of the included items, and a brief summary of the problem. A copy of your original sales receipt must be included for warranty consideration. Be sure your name, address, and RMA number are clearly written on the outside of the shipping carton.

**NOTICE: Do not ship LiPo batteries to Horizon. If you have any issue with a LiPo battery, please contact the appropriate Horizon Product Support office.**

### Warranty Requirements

**For Warranty consideration, you must include your original sales receipt verifying the proof-of-purchase date.** Provided warranty conditions have been met, your Product will be serviced or replaced free of charge. Service or replacement decisions are at the sole discretion of Horizon.

### Non-Warranty Service

**Should your service not be covered by warranty, service will be completed and payment will be required without notification or estimate of the expense unless the expense exceeds 50% of the retail purchase cost.** By submitting the item for service you are agreeing to payment of the service without notification. Service estimates are available upon request. You must include this request with your item submitted for service. Non-warranty service estimates will be billed a minimum of ½ hour of labor. In addition you will be billed for return freight. Horizon accepts money orders and cashier's checks, as well as Visa, MasterCard, American Express, and Discover cards. By submitting any item to Horizon for service, you are agreeing to Horizon's Terms and Conditions found on our website [http://www.horizonhobby.com/content/\\_service-center\\_render-service-center](http://www.horizonhobby.com/content/_service-center_render-service-center).

**ATTENTION: Horizon service is limited to Product compliant in the country of use and ownership. If received, a non-compliant Product will not be serviced. Further, the sender will be responsible for arranging return shipment of the un-serviced Product, through a carrier of the sender's choice and at the sender's expense. Horizon will hold non-compliant Product for a period of 60 days from notification, after which it will be discarded.**



## French Warranty

### **Durée de la garantie**

Garantie exclusive - Horizon Hobby, LLC (Horizon) garantit que le Produit acheté (le « Produit ») sera exempt de défauts matériels et de fabrication à sa date d'achat par l'Acheteur. La durée de garantie correspond aux dispositions légales du pays dans lequel le produit a été acquis. La durée de garantie est de 6 mois et la durée d'obligation de garantie de 18 mois à l'expiration de la période de garantie.

### **Limitations de la garantie**

(a) La garantie est donnée à l'acheteur initial (« Acheteur ») et n'est pas transférable. Le recours de l'acheteur consiste en la réparation ou en l'échange dans le cadre de cette garantie. La garantie s'applique uniquement aux produits achetés chez un revendeur Horizon agréé. Les ventes faites à des tiers ne sont pas couvertes par cette garantie. Les revendications en garantie seront acceptées sur fourniture d'une preuve d'achat valide uniquement. Horizon se réserve le droit de modifier les dispositions de la présente garantie sans avis préalable et révoque alors les dispositions de garantie existantes.

(b) Horizon n'endosse aucune garantie quant à la vendabilité du produit ou aux capacités et à la forme physique de l'utilisateur pour une utilisation donnée du produit. Il est de la seule responsabilité de l'acheteur de vérifier si le produit correspond à ses capacités et à l'utilisation prévue.

(c) Recours de l'acheteur – Il est de la seule discrétion d'Horizon de déterminer si un produit présentant un cas de garantie sera réparé ou échangé. Ce sont là les recours exclusifs de l'acheteur lorsqu'un défaut est constaté.

Horizon se réserve la possibilité de vérifier tous les éléments utilisés et susceptibles d'être intégrés dans le cas de garantie. La décision de réparer ou de remplacer le produit est du seul ressort d'Horizon. La garantie exclut les défauts esthétiques ou les défauts provoqués par des cas de force majeure, une manipulation incorrecte du produit, une utilisation incorrecte ou commerciale de ce dernier ou encore des modifications de quelque nature qu'elles soient.

La garantie ne couvre pas les dégâts résultant d'un montage ou d'une manipulation erronés, d'accidents ou encore du fonctionnement ainsi que des tentatives d'entretien ou de réparation non effectuées par Horizon. Les retours effectués par le fait de l'acheteur directement à Horizon ou à l'une de ses représentations nationales requièrent une confirmation écrite.

### **Limitation des dommages**

Horizon ne saurait être tenu pour responsable de dommages conséquents directs ou indirects, de pertes de revenus ou de pertes commerciales, liés de quelque manière que ce soit au produit et ce, indépendamment du fait qu'un recours puisse être formulé en relation avec un contrat, la garantie ou l'obligation de garantie. Par ailleurs, Horizon n'acceptera pas de recours issus d'un cas de garantie lorsque ces recours dépassent la valeur unitaire du produit. Horizon n'exerce aucune influence sur le montage, l'utilisation ou la maintenance du produit ou sur d'éventuelles combinaisons de produits choisies par l'acheteur. Horizon ne prend en compte aucune garantie et n'accepte aucun recours pour les blessures ou les dommages pouvant en résulter. Horizon Hobby ne saurait être tenu responsable d'une utilisation ne respectant pas les lois, les règles ou réglementations en vigueur.

En utilisant et en montant le produit, l'acheteur accepte sans restriction ni réserve toutes les dispositions relatives à la garantie figurant dans le présent document. Si vous n'êtes pas prêt, en tant qu'acheteur, à accepter ces dispositions en relation avec l'utilisation du produit, nous vous demandons de restituer au vendeur le produit complet, non utilisé et dans son emballage d'origine.

### **Indications relatives à la sécurité**

Ceci est un produit de loisirs perfectionné et non un jouet. Il doit être utilisé avec précaution et bon sens et nécessite quelques aptitudes mécaniques ainsi que mentales. L'incapacité à utiliser le produit de manière sûre et raisonnable peut provoquer des blessures et des dégâts matériels conséquents. Ce produit n'est pas destiné à être utilisé par des enfants sans la surveillance par un tuteur. La notice d'utilisation contient des indications relatives à la sécurité ainsi que



des indications concernant la maintenance et le fonctionnement du produit. Il est absolument indispensable de lire et de comprendre ces indications avant la première mise en service. C'est uniquement ainsi qu'il sera possible d'éviter une manipulation erronée et des accidents entraînant des blessures et des dégâts. Horizon Hobby ne saurait être tenu responsable d'une utilisation ne respectant pas les lois, les règles ou réglementations en vigueur.

### **Questions, assistance et réparations**

Votre revendeur spécialisé local et le point de vente ne peuvent effectuer une estimation d'éligibilité à l'application de la garantie sans avoir consulté Horizon. Cela vaut également pour les réparations sous garantie. Vous voudrez bien, dans un tel cas, contacter le revendeur qui conviendra avec Horizon d'une décision appropriée, destinée à vous aider le plus rapidement possible.

### **Maintenance et réparation**

Si votre produit doit faire l'objet d'une maintenance ou d'une réparation, adressez-vous soit à votre revendeur spécialisé, soit directement à Horizon. Emballez le produit soigneusement. Veuillez noter que le carton d'emballage d'origine ne suffit pas, en règle générale, à protéger le produit des dégâts pouvant survenir pendant le transport. Faites appel à un service de messagerie proposant une fonction de suivi et une assurance, puisque Horizon ne prend aucune responsabilité pour l'expédition du produit jusqu'à sa réception acceptée. Veuillez joindre une preuve d'achat, une description détaillée des défauts ainsi qu'une liste de tous les éléments distincts envoyés. Nous avons de plus besoin d'une adresse complète, d'un numéro de téléphone (pour demander des renseignements) et d'une adresse de courriel.

### **Garantie et réparations**

Les demandes en garantie seront uniquement traitées en présence d'une preuve d'achat originale émanant d'un revendeur spécialisé agréé, sur laquelle figurent le nom de l'acheteur ainsi que la date d'achat. Si le cas de garantie est confirmé, le produit sera réparé. Cette décision relève uniquement d'Horizon Hobby.

### **Réparations payantes**

En cas de réparation payante, nous établissons un devis que nous transmettons à votre revendeur. La réparation sera seulement effectuée après que nous ayons reçu la confirmation du revendeur. Le prix de la réparation devra être acquitté au revendeur. Pour les réparations payantes, nous facturons au minimum 30 minutes de travail en atelier ainsi que les frais de réexpédition. En l'absence d'un accord pour la réparation dans un délai de 90 jours, nous nous réservons la possibilité de détruire le produit ou de l'utiliser autrement.

**ATTENTION: Nous n'effectuons de réparations payantes que pour les composants électroniques et les moteurs. Les réparations touchant à la mécanique, en particulier celles des hélicoptères et des voitures radiocommandées, sont extrêmement coûteuses et doivent par conséquent être effectuées par l'acheteur lui-même.**

## **GARANTIE UND SERVICE INFORMATIONEN**

### **Warnung**

Ein ferngesteuertes Modell ist kein Spielzeug. Es kann, wenn es falsch eingesetzt wird, zu erheblichen Verletzungen bei Lebewesen und Beschädigungen an Sachgütern führen. Betreiben Sie Ihr RC-Modell nur auf freien Plätzen und beachten Sie alle Hinweise der Bedienungsanleitung des Modells wie auch der Fernsteuerung.

### **Garantiezeitraum**

Exklusive Garantie Horizon Hobby LLC (Horizon) garantiert, dass dasgekaufte Produkt frei von Material- und Montagefehlern ist. Der Garantiezeitraum entspricht den gesetzlichen Bestimmung des Landes, in dem das Produkt erworben wurde. In Deutschland beträgt der Garantiezeitraum 6 Monate und der Gewährleistungszeitraum 18 Monate nach dem Garantiezeitraum.

## **Einschränkungen der Garantie**

(a) Die Garantie wird nur dem Erstkäufer (Käufer) gewährt und kann nicht übertragen werden. Der Anspruch des Käufers besteht in der Reparatur oder dem Tausch im Rahmen dieser Garantie. Die Garantie erstreckt sich ausschließlich auf Produkte, die bei einem autorisierten Horizon Händler erworben wurden. Verkäufe an dritte werden von dieser Garantie nicht gedeckt. Garantieansprüche werden nur angenommen, wenn ein gültiger Kaufnachweis erbracht wird. Horizon behält sich das Recht vor, diese Garantiebestimmungen ohne Ankündigung zu ändern oder modifizieren und widerruft dann bestehende Garantiebestimmungen.

(b) Horizon übernimmt keine Garantie für die Verkaufbarkeit des Produktes, die Fähigkeiten und die Fitness des Verbrauchers für einen bestimmten Einsatzzweck des Produktes. Der Käufer allein ist dafür verantwortlich, zu prüfen, ob das Produkt seinen Fähigkeiten und dem vorgesehenen Einsatzzweck entspricht.

(c) Ansprüche des Käufers → Es liegt ausschließlich im Ermessen von Horizon, ob das Produkt, bei dem ein Garantiefall festgestellt wurde, repariert oder ausgetauscht wird. Dies sind die exklusiven Ansprüche des Käufers, wenn ein Defekt festgestellt wird.

Horizon behält sich vor, alle eingesetzten Komponenten zu prüfen, die in den Garantiefall einbezogen werden können. Die Entscheidung zur Reparatur oder zum Austausch liegt nur bei Horizon. Die Garantie schließt kosmetische Defekte oder Defekte, hervorgerufen durch höhere Gewalt, falsche Behandlung des Produktes, falscher Einsatz des Produktes, kommerziellen Einsatz oder Modifikationen irgendwelcher Art aus.

Die Garantie schließt Schäden, die durch falschen Einbau, falsche Handhabung, Unfälle, Betrieb, Service oder Reparaturversuche, die nicht von Horizon ausgeführt wurden aus.

Ausgeschlossen sind auch Fälle die bedingt durch (vii) eine Nutzung sind, die gegen geltendes Recht, Gesetze oder Regularien verstoßen haben. Rücksendungen durch den Käufer direkt an Horizon oder eine seiner Landesvertretung bedürfen der Schriftform.

## **Schadensbeschränkung**

Horizon ist nicht für direkte oder indirekte Folgeschäden, Einkommensausfälle oder kommerzielle Verluste, die in irgendeinem Zusammenhang mit dem Produkt stehen verantwortlich, unabhängig ob ein Anspruch im Zusammenhang mit einem Vertrag, der Garantie oder der Gewährleistung erhoben werden. Horizon wird darüber hinaus keine Ansprüche aus einem Garantiefall akzeptieren, die über den individuellen Wert des Produktes hinaus gehen. Horizon hat keinen Einfluss auf den Einbau, die Verwendung oder die Wartung des Produktes oder etwaiger Produktkombinationen, die vom Käufer gewählt werden. Horizon übernimmt keine Garantie und akzeptiert keine Ansprüche für in der Folge auftretende Verletzungen oder Beschädigungen. Mit der Verwendung und dem Einbau des Produktes akzeptiert der Käufer alle aufgeführten Garantiebestimmungen ohne Einschränkungen und Vorbehalte.

Wenn Sie als Käufer nicht bereit sind, diese Bestimmungen im Zusammenhang mit der Benutzung des Produktes zu akzeptieren, werden Sie gebeten, das Produkt in unbenutztem Zustand in der Originalverpackung vollständig bei dem Verkäufer zurückzugeben.

## **Sicherheitshinweise**

Dieses ist ein hochwertiges Hobby Produkt und kein Spielzeug. Es muss mit Vorsicht und Umsicht eingesetzt werden und erfordert einige mechanische wie auch mentale Fähigkeiten. Ein Versagen, das Produkt sicher und umsichtig zu betreiben kann zu Verletzungen von Lebewesen und Sachbeschädigungen erheblichen Ausmaßes führen. Dieses Produkt ist nicht für den Gebrauch durch Kinder ohne die Aufsicht eines Erziehungsberechtigten vorgesehen. Die Anleitung enthält Sicherheitshinweise und Vorschriften sowie Hinweise für die Wartung und den Betrieb des Produktes. Es ist unabdingbar, diese Hinweise vor der ersten Inbetriebnahme zu lesen und zu verstehen. Nur so kann der falsche Umgang verhindert und Unfälle mit Verletzungen und Beschädigungen vermieden werden.

### **Fragen, Hilfe und Reparaturen**

Ihr lokaler Fachhändler und die Verkaufsstelle können eine Garantiebeurteilung ohne Rücksprache mit Horizon nicht durchführen. Dies gilt auch für Garantiereparaturen. Deshalb kontaktieren Sie in einem solchen Fall den Händler, der sich mit Horizon kurz schließen wird, um eine sachgerechte Entscheidung zu fällen, die Ihnen schnellst möglich hilft.

### **Wartung und Reparatur**

Muss Ihr Produkt gewartet oder repariert werden, wenden Sie sich entweder an Ihren Fachhändler oder direkt an Horizon.

Rücksendungen / Reparaturen werden nur mit einer von Horizon vergebenen RMA Nummer bearbeitet. Diese Nummer erhalten Sie oder ihr Fachhändler vom technischen Service. Mehr Informationen dazu erhalten Sie im Serviceportal unter [www. Horizonhobby.de](http://www.Horizonhobby.de) oder telefonisch bei dem technischen Service von Horizon.

Packen Sie das Produkt sorgfältig ein. Beachten Sie, dass der Originalkarton in der Regel nicht ausreicht, um beim Versand nicht beschädigt zu werden.

Verwenden Sie einen Paketdienstleister mit einer Tracking Funktion und Versicherung, da Horizon bis zur Annahme keine Verantwortung für den Versand des Produktes übernimmt. Bitte legen Sie dem Produkt einen Kaufbeleg bei, sowie eine ausführliche Fehlerbeschreibung und eine Liste aller eingesendeten Einzelkomponenten. Weiterhin benötigen wir die vollständige Adresse, eine Telefonnummer für Rückfragen, sowie eine Email Adresse.

### **Garantie und Reparaturen**

Garantieanfragen werden nur bearbeitet, wenn ein Originalkaufbeleg von einem autorisierten Fachhändler beiliegt, aus dem der Käufer und das Kaufdatum hervorgeht. Sollte sich ein Garantiefall bestätigen wird das Produkt repariert oder ersetzt. Diese Entscheidung obliegt einzig Horizon Hobby.

### **Kostenpflichtige Reparaturen**

Liegt eine kostenpflichtige Reparatur vor, erstellen wir einen Kostenvoranschlag, den wir Ihrem Händler übermitteln. Die Reparatur wird erst vorgenommen, wenn wir die Freigabe des Händlers erhalten. Der Preis für die Reparatur ist bei Ihrem Händler zu entrichten. Bei kostenpflichtigen Reparaturen werden mindestens 30 Minuten Werkstattzeit und die Rückversandkosten in Rechnung gestellt. Sollten wir nach 90 Tagen keine Einverständniserklärung zur Reparatur vorliegen haben, behalten wir uns vor, das Produkt zu vernichten oder anderweitig zu verwerten.

**ACHTUNG: Kostenpflichtige Reparaturen nehmen wir nur für Elektronik und Motoren vor. Mechanische Reparaturen, besonders bei Hubschraubern und RC-Cars sind extrem aufwendig und müssen deshalb vom Käufer selbst vorgenommen werden.**

## **INTERNATIONAL CUSTOMER WARRANTY**

Please contact the dealer where the purchase was made. If your Axial product purchase was made through an on-line retailer, any warranty issues must be taken care of by that retailer. Axial assumes no responsibility for Axial products sold internationally by on-line retailers outside of your home country/region.

## **SPECIFICATIONS & DESCRIPTION CHANGES**

All information found in this manual is subject to change without notice. Visit [Axialracing.com](http://Axialracing.com) for the latest updates and information regarding your model. Axial maintains no responsibility for inadvertent errors in this manual or on the box art.



## FCC STATEMENT

This device complies with part 15 of the FCC rules. Operation is subject to the following two conditions.



- (1) This device may not cause harmful interference.
- (2) This device must accept any interference received, including interference that may cause undesired operation.

**FCC RF RADIATED EXPOSURE STATEMENT:** The equipment complies with FCC Rf radiation exposure limits set forth for an uncontrolled environment. This equipment should be installed and operated with a minimum distance of 20 centimeters between the radiator and your body.

**NOTE: THE MANUFACTURER IS NOT RESPONSIBLE FOR ANY RADIO OR TV INTERFERENCE CAUSED BY UNAUTHORIZED MODIFICATIONS TO THIS EQUIPMENT. SUCH MODIFICATIONS COULD VOID THE USER'S AUTHORITY TO OPERATE THE EQUIPMENT.**

**FCC ID: IYFTTX300**

## INDUSTRY CANADA NOTICE

This device complies with Industry Canada license-exempt RSS standard(s).

1. Operation is subject to the following two conditions: (1) this device may not cause interference, and (2) this device must accept any interference, including interference that may cause undesired operation of the device.
2. Changes or modifications not expressly approved by the party responsible for compliance could void the user's authority to operate the equipment.

This equipment complies with IC radiation exposure limits set forth for an uncontrolled environment. In order to avoid the possibility of exceeding the IC radio frequency exposure limits, Human proximity to the antenna shall not be less than 20cm (8 inches) during normal operation.

Avis d'Industrie Canada

Le présent appareil est conforme aux CNR d'Industrie Canada applicables aux appareils radio exempts de licence. L'exploitation est autorisée aux deux conditions suivantes : (1) l'appareil ne doit pas produire de brouillage, et (2) l'utilisateur de l'appareil doit accepter tout brouillage radioélectrique subi, même si le brouillage est susceptible d'en compromettre le fonctionnement. Cet appareil numérique ne dépasse pas les Rèlements sur l'interférence radio par un appareil numérique de classe B stipulées dans les Règlement sur l'interférence radio d'industrie Canada.

2. Les changements ou modifications de cette unité non expressément approuvés par la partie responsable de la conformité pourraient annuler l'autorité de l'utilisateur à utiliser l'équipement.

IC RF Déclaration sur la radioexposition:

Cet appareil est conforme avec l'exposition aux radiations IC Définies pour un environnement non contrôlé. Les utilisateurs finaux doivent suivre les instructions de fonctionnement spécifiques pour satisfaire la conformité aux expositions RF.

# English

## Contact Information\*

| Country of Purchase      | Horizon Hobby   | Contact Information                              | Address   |
|--------------------------|---|--|---|
| United States of America | Horizon Service Center<br>(Repairs and Repair Requests)   | servicecenter.horizonhobby.com/RequestForm/      | 1608 Interstate Drive<br>Champaign, Illinois<br>61822 USA |
|                          | Horizon Product Support<br>(Product Technical Assistance) | productsupport@horizonhobby.com<br>877-504-0233  |   |
|                          | Sales   | sales@horizonhobby.com<br>888-959-2306           |   |
| European Union           | Horizon Technischer Service<br>Sales: Horizon Hobby GmbH  | service@horizonhobby.eu<br>+49 (0) 4121 2655 100 | Hanskampring 9<br>D 22885 Barsbüttel, Germany             |

\* For the most up-to-date customer service contact information, visit: [www.horizonhobby.com/content/service-center-render-service-center](http://www.horizonhobby.com/content/service-center-render-service-center)

## Compliance Information for the European Union



**EU Compliance Statement:** Horizon Hobby, LLC hereby declares that this product is in compliance with the essential requirements and other relevant provisions of the RED and EMC Directive.

A copy of the EU Declaration of Conformity is available online at:  
<http://www.horizonhobby.com/content/support-render-compliance>.

### Instructions for disposal of WEEE by users in the European Union



This product must not be disposed of with other waste. Instead, it is the user's responsibility to dispose of their waste equipment by handing it over to a designated collection point for the recycling of waste electrical and electronic equipment. The separate collection and recycling of your waste equipment at the time of disposal will help to conserve natural resources and ensure that it is recycled in a manner that protects human health and the environment. For more information about where you can drop off your waste equipment for recycling, please contact your local city office, your household waste disposal service or where you purchased the product.

# German

## Garantie und Service Kontaktinformationen

| Land des Kauf     | Horizon Hobby               | Telefon/E-mail Adresse  | Adresse                                       |
|-------------------|-----------------------------|-------------------------|---|
| Europäische Union | Horizon Technischer Service | service@horizonhobby.de | Hanskampring 9<br>D 22885 Barsbüttel, Germany |
|                   | Sales: Horizon Hobby GmbH   | +49 (0) 4121 2655 100   |   |

## Rechtliche Informationen für die Europäische Union



### EU Konformitätserklärung

Horizon LLC erklärt hiermit, dass dieses Produkt konform zu den essentiellen Anforderungen der RED und EMC Direktive ist.

Eine Kopie der Konformitätserklärung ist online unter folgender Adresse verfügbar :  
<http://www.horizonhobby.com/content/support-render-compliance>.

### Anweisungen zur Entsorgung von Elektro- und Elektronik-Altgeräten für Benutzer in der Europäischen Union



Dieses Produkt darf nicht zusammen mit anderem Abfall entsorgt werden. Stattdessen ist der Benutzer dafür verantwortlich, unbrauchbare Geräte durch Abgabe bei einer speziellen Sammelstelle für das Recycling von unbrauchbaren elektrischen und elektronischen Geräten zu entsorgen. Die separate Sammlung und das Recycling von unbrauchbaren Geräten zum Zeitpunkt der Entsorgung hilft, natürliche Ressourcen zu bewahren und sicherzustellen, dass Geräte auf eine Weise wiederverwertet werden, bei der die menschliche Gesundheit und die Umwelt geschützt werden. Weitere Informationen dazu, wo Sie unbrauchbare Geräte zum Recycling abgeben können, erhalten Sie bei lokalen Ämtern, bei der Müllabfuhr für Haushaltsmüll sowie dort, wo Sie das Produkt gekauft haben.

## French

### Coordonnées de Garantie et réparations

| Pays d'achat     | Horizon Hobby               | Numéro de téléphone/E-mail | Adresse                                       |
|------------------|-----------------------------|----------------------------|---|
| Union européenne | Horizon Technischer Service | service@horizonhobby.de    | Hanskampring 9<br>D 22885 Barsbüttel, Germany |
|                  | Sales: Horizon Hobby GmbH   | +49 (0) 4121 2655 100      |   |

### IC Déclaration

IC: IYFTTX300

Le présent appareil est conforme aux CNR d'Industrie Canada applicables aux appareils radio exempts de licence. L'exploitation est autorisée aux deux conditions suivantes : (1) l'appareil ne doit pas produire de brouillage, et (2) l'utilisateur de l'appareil doit accepter tout brouillage radioélectrique subi, même si le brouillage est susceptible d'en compromettre le fonctionnement.

**REMARQUE:** Toute modification de ce produit annule l'autorité de l'utilisateur à utiliser cet équipement.

### Informations de conformité pour l'Union européenne



#### Déclaration de conformité de l'Union européenne :

Horizon Hobby, LLC déclare par la présente que ce produit est en conformité avec les exigences essentielles et les autres dispositions des directives RED et CEM.

Une copie de la déclaration de conformité européenne est disponible à :  
<http://www.horizonhobby.com/content/support-render-compliance>.

### Instructions relatives à l'élimination des D3E pour les utilisateurs résidant dans l'Union européenne



Ce produit ne doit pas être éliminé avec d'autres déchets. Il relève de la responsabilité de l'utilisateur d'éliminer les équipements mis au rebut en les remettant à un point de collecte désigné en vue du recyclage des déchets d'équipements électriques et électroniques. La collecte et le recyclage séparés de vos équipements au moment de leur élimination aideront à préserver les ressources naturelles et à garantir que les déchets seront recyclés de manière à protéger la santé humaine et l'environnement. Pour plus d'informations quant aux lieux de dépôt de vos équipements mis au rebut en vue du recyclage, veuillez contacter votre mairie, votre service de traitement des ordures ménagères ou le magasin dans lequel vous avez acheté le produit.

## Italian

### Garanzia e Assistenza - Informazioni per i contatti

| Stato di acquisto | Horizon Hobby               | Telefono/Indirizzo e-mail | Indirizzo                                     |
|-------------------|-----------------------------|---------------------------|---|
| Unione Europea    | Horizon Technischer Service | service@horizonhobby.de   | Hanskampring 9<br>D 22885 Barsbüttel, Germany |
|                   | Sales: Horizon Hobby GmbH   | +49 (0) 4121 2655 100     |   |

### Informazioni sulla conformità per l'Unione Europea



#### Dichiarazione di Conformità EU:

Horizon Hobby, LLC con la presente dichiara che il prodotto è conforme ai requisiti essenziali e ad altre disposizioni rilevanti delle direttive RED e EMC.

Una copia della dichiarazione di conformità per l'Unione Europea è disponibile a:  
<http://www.horizonhobby.com/content/support-render-compliance>.

### Istruzioni del RAEE per lo smaltimento da parte di utenti dell'Unione Europea



Questo prodotto non deve essere smaltito assieme ai rifiuti domestici. Al contrario, l'utente è responsabile dello smaltimento di tali rifiuti che devono essere portati in un centro di raccolta designato per il riciclaggio di rifiuti elettrici e apparecchiature elettroniche. La raccolta differenziata e il riciclaggio di tali rifiuti provenienti da apparecchiature nel momento dello smaltimento aiuteranno a preservare le risorse naturali e garantiranno un riciclaggio adatto a proteggere il benessere dell'uomo e dell'ambiente. Per maggiori informazioni sui centri di raccolta, contattare il proprio ufficio locale, il servizio di smaltimento rifiuti o il negozio presso il quale è stato acquistato il prodotto.



## WATER-RESISTANT VEHICLE WITH WATERPROOF ELECTRONICS

Your new Horizon Hobby vehicle has been designed and built with a combination of waterproof and water-resistant components to allow you to operate the product in many “wet conditions,” including puddles, creeks, wet grass, snow and even rain.

While the entire vehicle is highly water-resistant, it is not completely waterproof and your vehicle should NOT be treated like a submarine. The various electronic components used in the vehicle, such as the Electronic Speed Control (ESC) and servo(s) are waterproof, however, most of the mechanical components are water-resistant and should not be submerged.

Metal parts, including the bearings, hinge pins, screws and nuts, as well as the contacts in the electrical cables, will be susceptible to corrosion if additional maintenance is not performed after running in wet conditions. To maximize the long-term performance of your vehicle and to keep the warranty intact, the procedures described in the “Wet Conditions Maintenance” section below must be performed regularly if you choose to run in wet conditions. If you are not willing to perform the additional care and maintenance required, then you should not operate the vehicle in those conditions.



**CAUTION:** Failure to exercise caution while using this product and complying with the following precautions could result in product malfunction and/or void the warranty.

### Wet Conditions Maintenance

- Remove the battery pack(s) and dry the contacts. If you have an air compressor or a can of compressed air, blow out any water that may be inside the recessed connector housing.
- Remove the tires/wheels from the vehicle and gently rinse the mud and dirt off with a garden hose. Avoid rinsing the bearings and transmission.

**NOTICE:** Never use a pressure washer to clean your vehicle.

- Use an air compressor or a can of compressed air to dry the vehicle and help remove any water that may have gotten into small crevices or corners.

### General Precautions

- Read through the wet conditions maintenance procedures and make sure that you have all the tools you will need to properly maintain your vehicle.
- Not all batteries can be used in wet conditions. Consult the battery manufacturer before use. Do not use Li-Po batteries in wet conditions.
- The included transmitter is not waterproof or water-resistant. If using a different transmitter than the one included, consult your transmitter's manual or the manufacturer before operation.
- Never operate your transmitter or vehicle where lightning may be present.
- Do not operate your vehicle where it could come in contact with salt water (ocean water or water on salt-covered roads), contaminated or polluted water. Salt water is very conductive and highly corrosive, so use caution.
- Even minimal water contact can reduce the life of your motor if it has not been certified as water-resistant or waterproof. If the motor becomes excessively wet, apply very light throttle until the water is mostly removed from the motor. Running a wet motor at high speeds may rapidly damage the motor.
- Driving in wet conditions can reduce the life of the motor. The additional resistance of operating in water causes excess strain. Alter the gear ratio by using a smaller pinion or larger spur gear. This will increase torque (and motor life) when running in mud, deeper puddles, or any wet conditions that will increase the load on the motor for an extended period of time.
- Spray the bearings, drive train, fasteners and other metal parts with a water-displacing light oil or lubricant. Do not spray the motor.
- Let the vehicle air dry before you store it. Water (and oil) may continue to drip for a few hours.
- Increase the frequency of disassembly, inspection and lubrication of the following:
  - Front and rear axle hub assembly bearings.
  - All transmission cases, gears and differentials.
  - Motor—clean with an aerosol motor cleaner and re-oil the bushings with lightweight motor oil.

## CAUTIONS



To prevent serious personal injury and/or property damage, operate all remotely controlled models in a responsible manner as outlined herein.

### CHOOSE THE RIGHT PLACE TO OPERATE YOUR R/C MODEL.

- Do not run on public streets or highways. This could cause serious accidents, personal injuries, and/or property damage.
- Never run R/C models near people or animals.
- To avoid injury, do not run in confined spaces.
- Do not run where loud noises can disturb others, such as hospitals and residential areas.
- Never run indoors. There is a high risk of fire and/or damage.

### INSPECT YOUR MODEL BEFORE OPERATION.

- Make sure that all screws and nuts are properly tightened. It is also a good idea to use removable thread lock wherever metal screws go into metal, especially for engine mounts and the engine pilot shaft.
- Always use fresh batteries for your transmitter and for your receiver to avoid losing control of the model.
- Always test the brakes and throttle before starting your engine to avoid losing control of the model.

### AFTER OPERATION OF YOUR R/C MODEL

- Disconnect battery in vehicle first, then turn off transmitter, this will prevent runaways.
- Be careful when handling batteries, they will be hot after running.
- Replace any batteries that have been dented or have frayed wires, short circuits can cause fire.
- Be sure to keep your R/C model clean and free of excess dirt and grease, this will increase the life.

## VORSICHT!



Um Verletzungen an Personen und/oder Sachschäden zu vermeiden, sollten alle ferngesteuerten Modelle sorgfältig und verantwortungsbewusst bedient werden, wie nachfolgend beschrieben.

### Wählen Sie den richtigen Platz zum Fahren

- Fahren Sie niemals auf öffentlichen Straßen. Dies könnte Verkehrsunfälle, Personenschäden oder Sachschäden verursachen.
- Fahren Sie niemals in der Nähe von anderen Personen oder Tieren.
- Fahren Sie niemals auf belebten Straßen.
- Fahren Sie nie in der Nähe von Wohnhäusern oder Krankenhäusern. Der Lärm könnte andere Personen stören.
- Fahren Sie niemals in Innenräumen. Dort könnte etwas beschädigt werden.

### Überprüfen Sie Ihr Modell, bevor Sie es in Betrieb nehmen.

- Gehen Sie sicher, dass alle Schrauben und Muttern festgezogen sind. Verwenden Sie überall dort Schrauben-Sicherungslack, wo Metallschrauben in ein Metallgewinde greifen, besonders bei den Motorhaltern.
- Um Störungen zu vermeiden, benutzen Sie immer voll geladene Akkus in Ihrem Sender und Empfänger.
- Bevor Sie den Motor starten, sollten Sie immer die Funktion der Bremse und des Gashebels testen.

### Nach Betrieb des RC Modells:

- Zuerst den Empfänger abdrehen, dann den Sender abdrehen um unkontrolliertes Durchgehen zu vermeiden.
- Seien Sie vorsichtig mit gebrauchten Akkus, sie können nach dem Gebrauch heiß sein.
- Ersetzen Sie Akkus/Batterien die beschädigt sind oder schadhafte Kabel aufweisen, sie können Kurzschlüsse oder Feuer verursachen.
- Halten Sie Ihr Fahrzeug sauber und entfernen Sie Schmutz und Schmierfett, damit erhöhen Sie die Lebensdauer Ihres Modells.

## PRECAUTIONS



Afin d'éviter toutes blessures corporelles et/ou dommages environnants, veuillez procéder en toute responsabilité comme indiqué ci-dessous

### Choisir le lieu adéquat pour faire rouler votre modèle.

- Ne jamais rouler dans les rues ou sur les routes ouvertes au publique. Ceci peut provoquer de graves accidents.
- Ne jamais rouler près de personnes ou d'animaux.
- Pour éviter les blessures, ne pas rouler dans des espaces confinés.
- Ne jamais rouler où le bruit peut déranger, comme aux abords des hôpitaux ou des quartiers résidentiels.
- Ne jamais rouler à l'intérieur: les gaz d'échappement sont nocifs.

### Controler votre modèle avant chaque utilisation.

- Vérifier que les vis et les écrous sont bien serrés. Il est très fortement conseillé d'utiliser du frein filet pour bloquer les vis qui sont en contact avec du métal et tout particulièrement les vis du moteur.
- Toujours utiliser des batteries bien chargées pour l'émission et la réception.
- Toujours vérifier les freins et la commande des gaz avant de démarrer.

### Après l'Opération De Votre Modèle de R/C

- Le virage du récepteur premier, alors virage de l'émetteur, ceci empêchera des fugitifs.
- Faire attention en contrôlant des piles, ils auront chaud après avoir couru.
- Remplacer n'importe quelles piles qui ont été cabossées ou a éraillé des fils, les court-circuits peuvent causer le feu.
- Etre sûr de garder votre modèle de R/C nettoie et libère de terre et la graisse supplémentaires, ceci augmentera la vie.

**Problem**  
**Problem**  
**Problème**

**Cause**  
**Grund**  
**Cause**

**Remedy**  
**Lösung**  
**Remède**

**Does not move**  
**Das Auto fährt nicht**  
**Le véhicule ne bouge pas**

**Batteries are not installed properly in the transmitter.**  
**Die Batterien sitzen nicht korrekt im Sender.**  
**Les piles ne sont pas placées correctement dans l'émetteur.**

**Weak or no battery in model.**  
**Leerer oder kein Akku im Auto.**  
**Batterie faible ou non installée**

**Damaged motor.**  
**Kaputter Motor.**  
**Moteur endommagé**

**Frayed or broken wiring.**  
**Beschädigte Verkabelung.**  
**Câble dénudé ou coupe**

**ESC is shut down by heat protection circuit.**  
**Notabschaltung des Reglers wegen Überhitzung.**  
**Le système ESC est fermé par le circuit de protection thermique.**

**Make sure batteries are properly installed.**  
**Legen Sie die Batterien korrekt ein.**  
**Positionnez correctement les piles dans l'émetteur.**

**Install charged battery.**  
**Einbauen eines geladenen Akkus.**  
**Mettez en place une batterie chargée**

**Replace with new motor.**  
**Austausch durch einen neuen Motor.**  
**Remplacez par un nouveau moteur**

**Splice and insulate wiring completely.**  
**Erneuern und isolieren Sie die kaputte Stelle.**  
**Faites une épissure et isolez complètement le câble.**

**Stop driving immediately, do not drive the car until the Speed Controller cools down.**  
**Fahren Sie nicht weiter. Warten Sie bis der Fahrten regler abgekühlt ist.**  
**Arrêtez immédiatement de conduire, ne pilotez pas la voiture tant que le contrôleur de vitesse n'a pas refroidi.**

**No Control.**  
**Keine Kontrolle über das Auto**  
**Pas de contrôle**

**Improper antenna on transmitter or model.**  
**Zu kurze Antenne am Sender oder Auto.**  
**Antenne inadéquate sur l'émetteur ou le véhicule**

**Weak or no batteries in transmitter or model.**  
**Leere oder keine Batterien im Sender oder Auto.**  
**Batterie faible ou absente dans l'émetteur ou le véhicule.**

**Neutral position or trim is incorrect.**  
**Neutralposition oder Trimmung sind verstellt.**  
**La position neutre est incorrecte ou le trim n'est pas réglé.**

**Are the receiver and battery connections properly connected?**  
**Sind der Empfänger und die Batterieverbindungen ordentlich verbunden?**  
**Son conectadas apropiadamente las conexiones del receptor y la batería?**

**Install charged or fresh batteries.**  
**Einbauen voller Batterien.**  
**Mettez des batteries rechargées ou neuves.**

**Fully extend antenna.**  
**Ziehen Sie die Antenne vollständig aus.**  
**Dépliez complètement l'antenne.**

**Adjust the steering trim.**  
**Stellen Sie die Lenkungstrimmung neu ein.**  
**Réglez le trim de direction.**

**Check receiver and battery connections.**  
**Prüfen Sie Empfänger und Batterieverbindungen.**  
**Compruebe conexiones de batería y receptor.**

**Steering and Throttle Function Reversed.**  
**Lenkung und Gas funktionieren genau verkehrt herum.**  
**Direction et accélération inverses.**

**Servo reverse switch is in wrong position.**  
**Servorichtungs-Schalter ist in der falschen Position.**  
**L'interrupteur de marche arrière du servo est dans la mauvaise position**

**Please check that the wires from ESC to motor are connected properly.**  
**Bitte überprüfen Sie, ob die Kabel vom Regler zum Motor richtig sitzen.**  
**Veillez vérifier que les fils allant de l'ESC au moteur sont correctement raccordés.**

**Set to correct position.**  
**Satz, Position zu korrigieren**  
**Vérifiez la position correcte**

**Check to make sure motor and ESC are properly connected.**  
**Kontrolle sich zu vergewissern, dass Motor und ESC ordentlich verbunden sind.**  
**Le contrôle pour assurer que le moteur et ESC est convenablement connecté.**



**Included items / Im Baukasten enthalten / Outils inclus dans le kit**

Radio control car  
Ferngesteuertes Modellauto  
Voiture radio-commandée

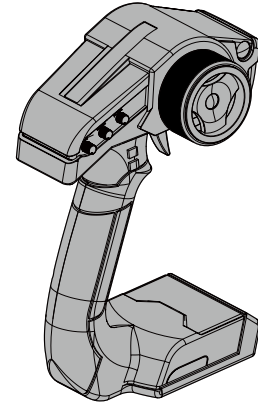
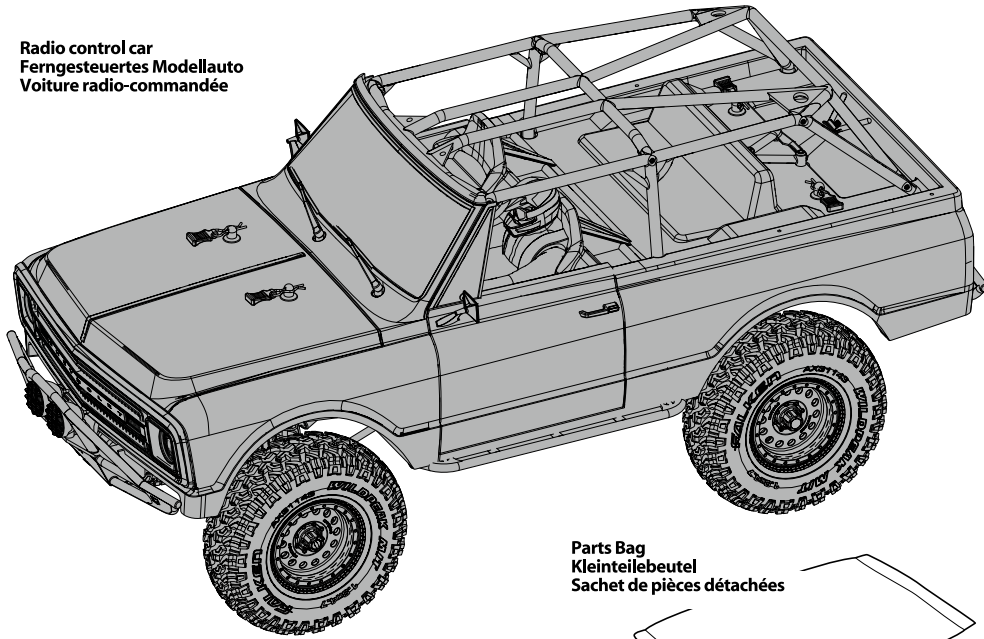

2.4GHz  
Transmitter  
Sender  
Emetteur

Parts Bag  
Kleinteilebeutel  
Sachet de pièces détachées

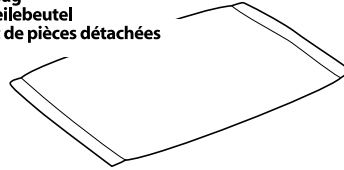

Cross wrench  
Steckschlüssel  
Clé à tube

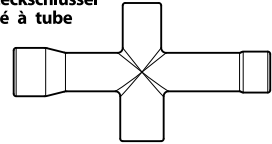

**Equipment needed / Benötigtes Zubehör / Equipement nécessaire**

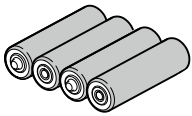

x4

4 AA Alkaline Dry Batteries.  
4 St. AA Trockenbatterien.  
4 piles type R6 pour votre  
radio commande.

Li-Po or Ni-MH Battery Pack  
Akku-Pack  
Pack de batterie

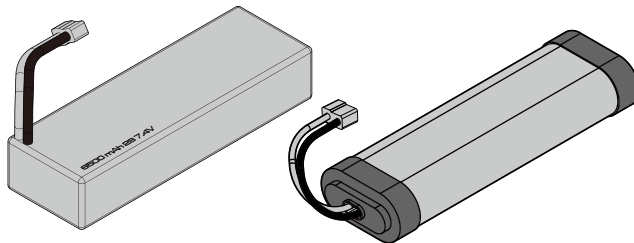

T-Style Battery Connector Required.

Charger  
Ladegerät  
Chargeur

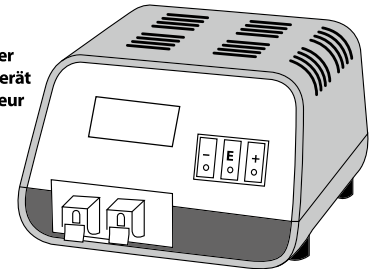

**Tools Recommended / Benötigte Werkzeuge / Outillage**

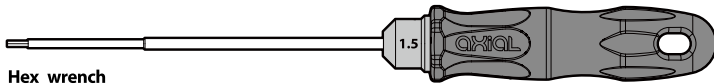

Hex wrench  
Inbusschlüssel  
Clé Allen

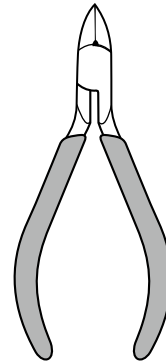
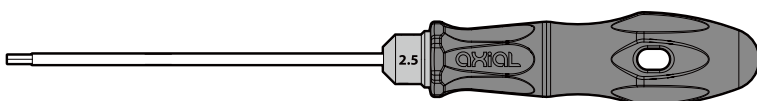
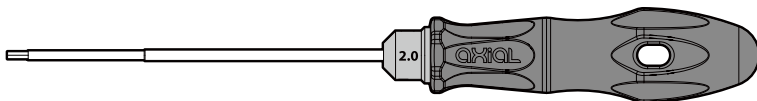

Side cutter  
Seitenschneider  
Pinces coupantes

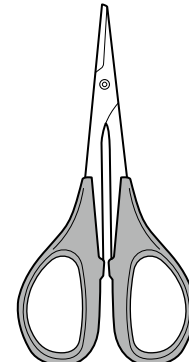

Curved scissors  
Schere  
Ciseaux

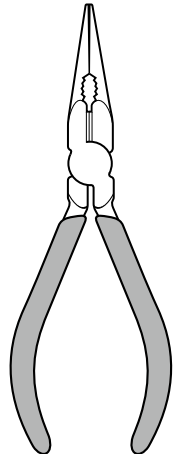

Long nose pliers  
Flachzange  
Pinces à becs longs

Modeling knife  
Modelliermesser  
Couteau de modéliste

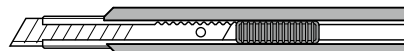

Charge your battery / Laden des Fahrakkus / Chargement de la batterie

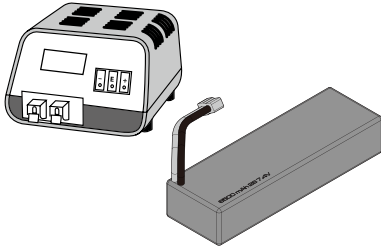

Follow the manufacturer's directions for the charger you purchased to properly charge your batteries.

Folgen Sie den Herstelleranweisungen für den Auflader Ihres gekauften ordentlich, Ihre Batterien zu laden.

Suivre les directions de fabricants pour le chargeur votre a acheté convenablement pour charger vos piles.

**Make sure charger is correct for battery type selected for use. Examples: Do NOT charge Lipo batteries with Nickel Metal Hydride charger. Do NOT charge Nickel Cadmium batteries Lipo charger.**

Stellen Sie sicher, Ladegerät ist korrekt für Batterietyp zur Verwendung ausgewählt. Beispiele: Laden Sie keine Lipo-Akkus mit Nickel-Metall-Hydrid-Ladegerät. Laden Sie keine Nickel-Cadmium-Akkus Lipo Ladegerät.

Assurez-vous que le chargeur est correcte pour le type de batterie sélectionné à l'emploi. Exemples: Ne pas charger les batteries Lipo avec chargeur hydrure métallique de nickel. Ne chargez pas les batteries au nickel-cadmium Lipo chargeur.

1. Turn on the transmitter.

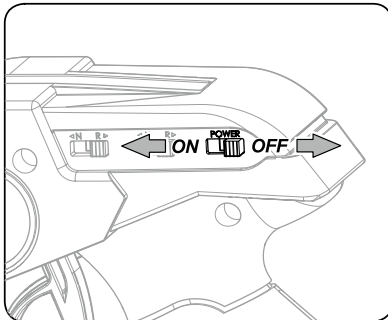

3. Connect the battery to ESC. Re-attach the body with body clips.

2. Remove the body clips and body. Install the battery and secure with Hook and Loop Strap.

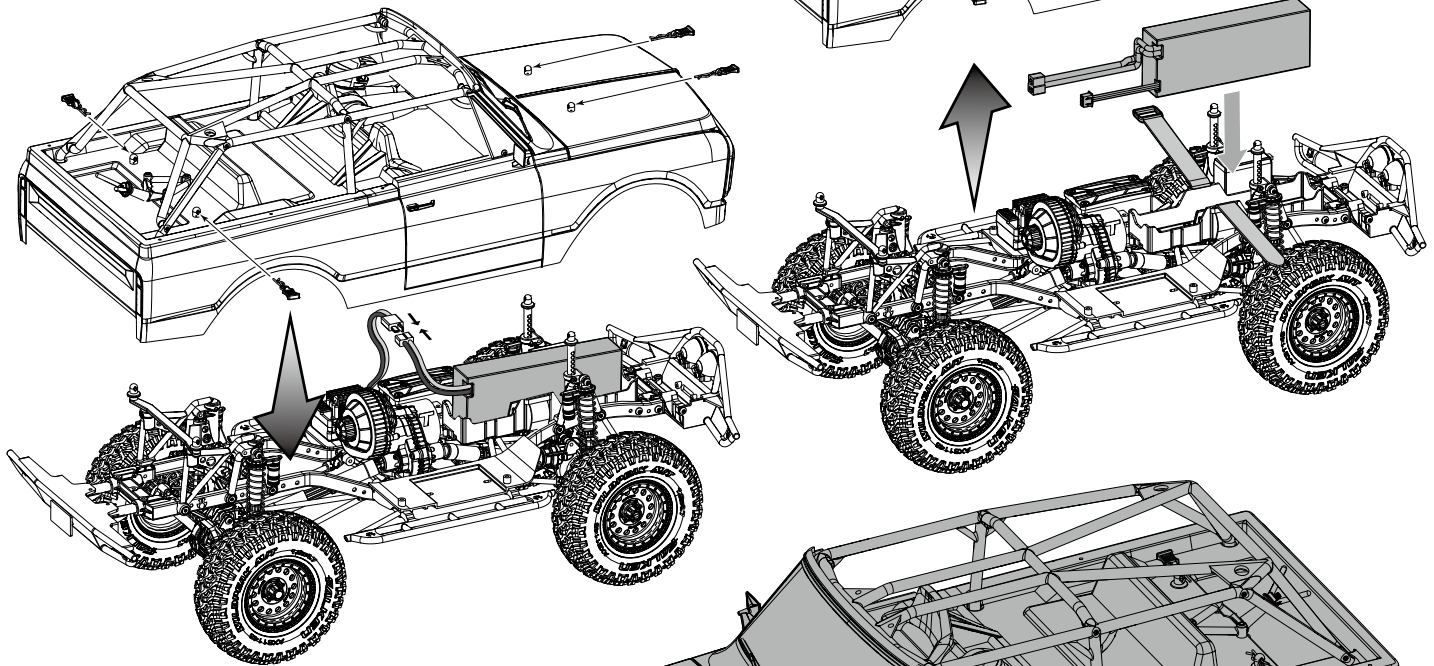

Note: Power to the vehicle is controlled by connecting / disconnecting the battery. Always make sure to disconnect battery when not in use.

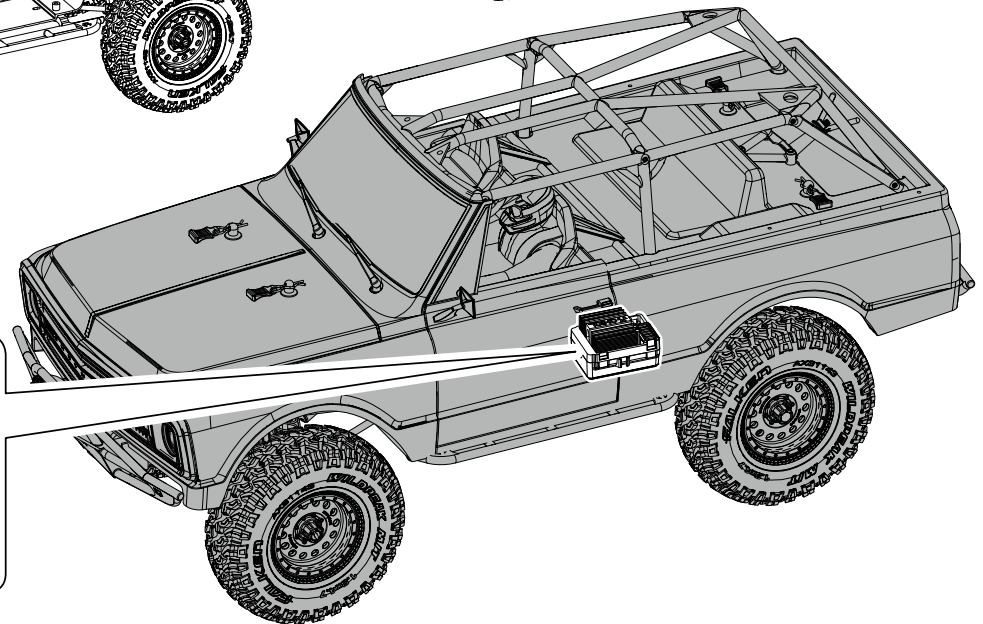
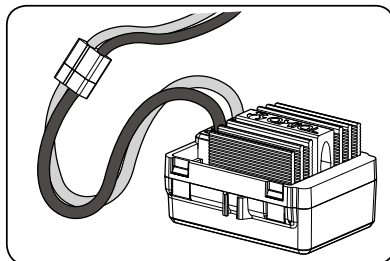

# Top View Parts

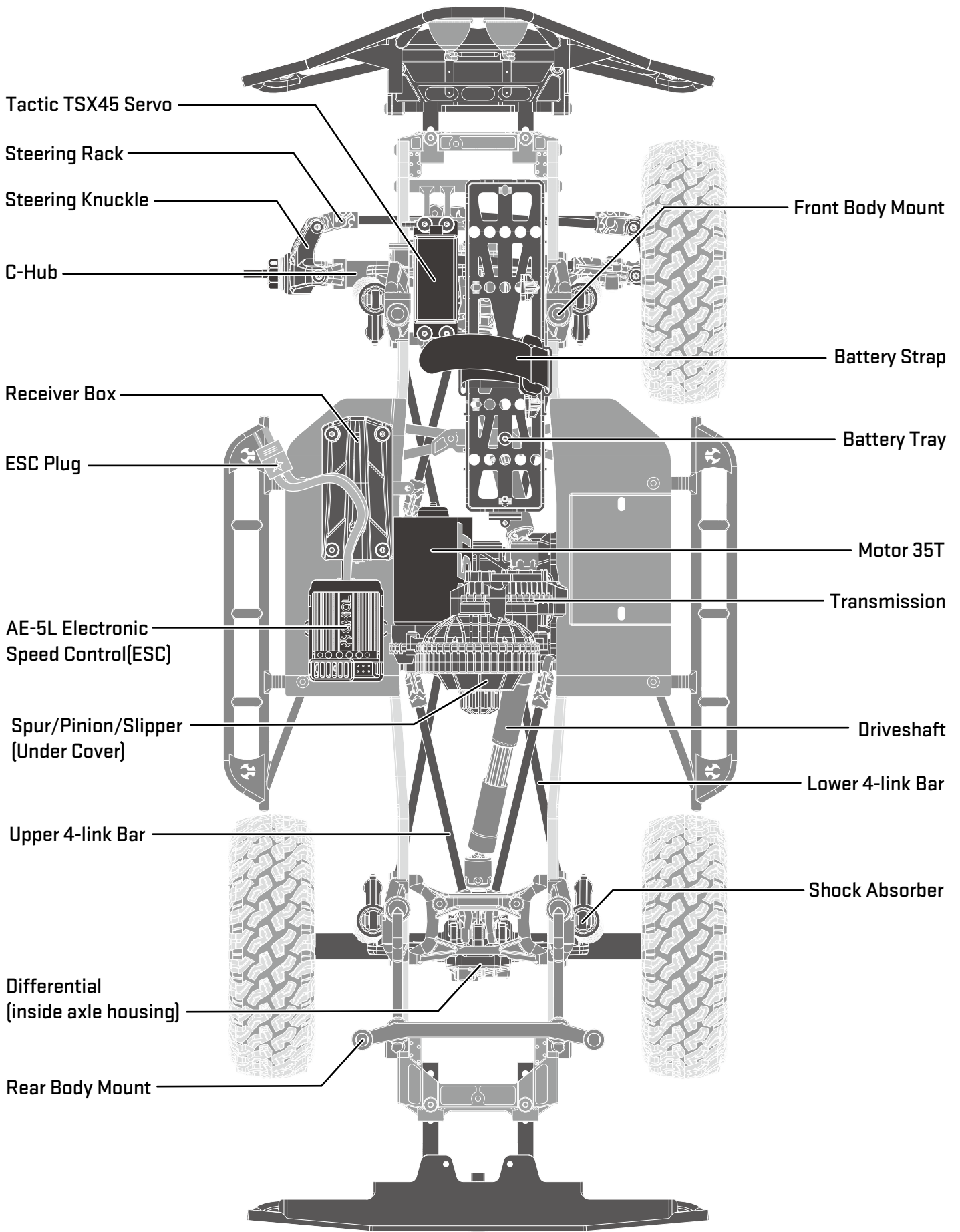

# Getting-Started Checklist

The following checklist is a guide for getting you vehicle running for the first time.

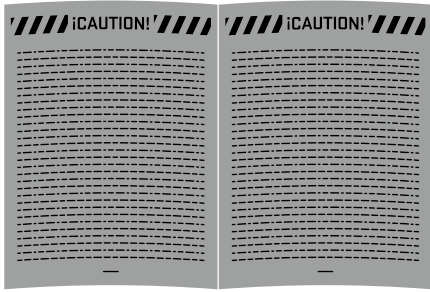

Read 'Cautions' in Manual. (Page 2)

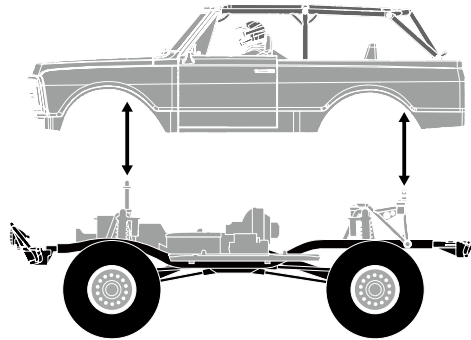

Familiarize yourself with vehicle and its components.

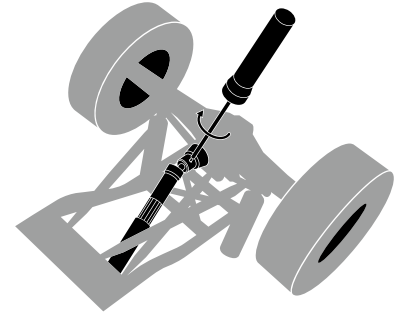

Even though the vehicle is new check driveshaft setscrews and other screws to make sure they are tight from the factory.

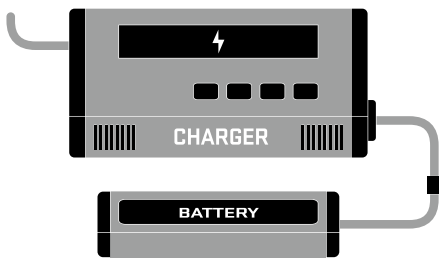

Charge battery pack. (Page 4)

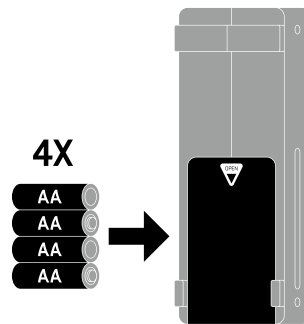

Install 4X AA batteries into Transmitter. (Page 7)

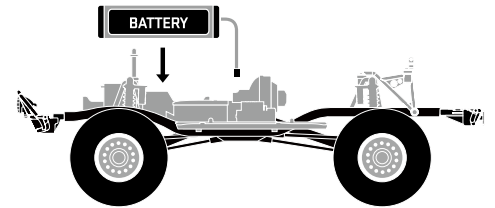

Install battery pack in vehicle. (Page 4)

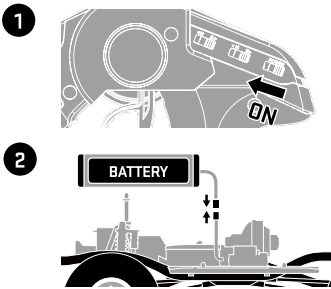

Turn on transmitter first, then plug in battery. (power ESC) (Page 4)

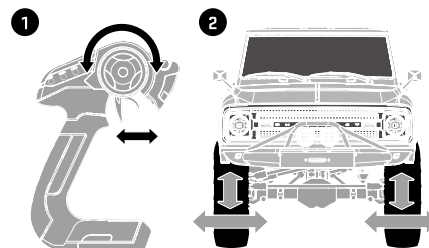

Check to make sure steering and throttle operation work correctly. (Page 7)



Range check radio system. (Page 7)

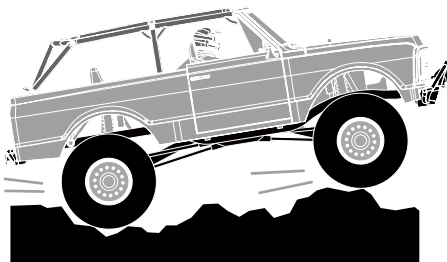

Drive vehicle, challenge yourself and have fun!

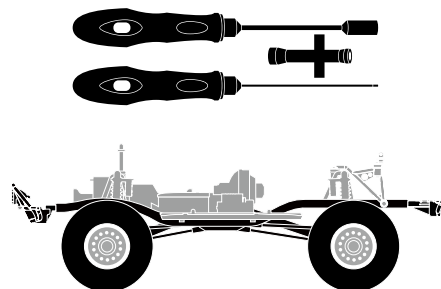

Maintain vehicle. (Page 7)



## Range-Checking Your Radio System

The radio system should be checked before operating the vehicle to ensure it's operating properly and has adequate range.



1. Turn on the transmitter and then connect the battery in the vehicle.
2. Have a friend hold the vehicle while keeping hands and loose clothing away from moving parts.
3. Walk away until you are at the farthest distance you plan to operate the vehicle.
4. Steer the vehicle back and forth and throttle both forward and reverse making sure there is no erratic behavior.
5. If any erratic behavior is exhibited do not operate the vehicle, call customer service for further assistance.



RANGE-CHECKING FOR DISTANCE

## Maintaining Your Vehicle

Just like a full size car or truck your RC vehicle must undergo periodic maintenance in order to ensure peak running performance. Preventative maintenance will also help avoid needless breakages which could result in costly repairs. Below are some suggestions to properly maintain your vehicle.

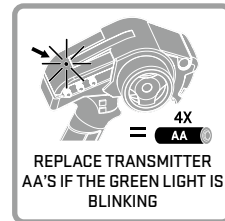
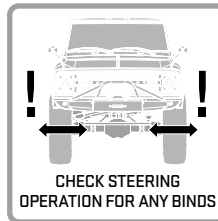
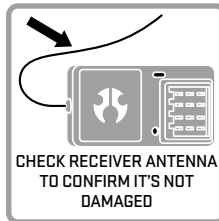
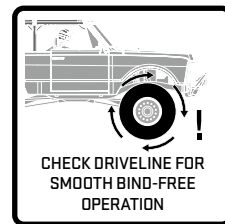
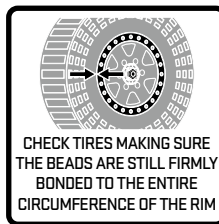
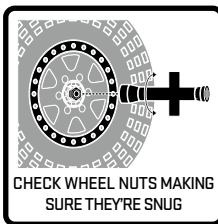
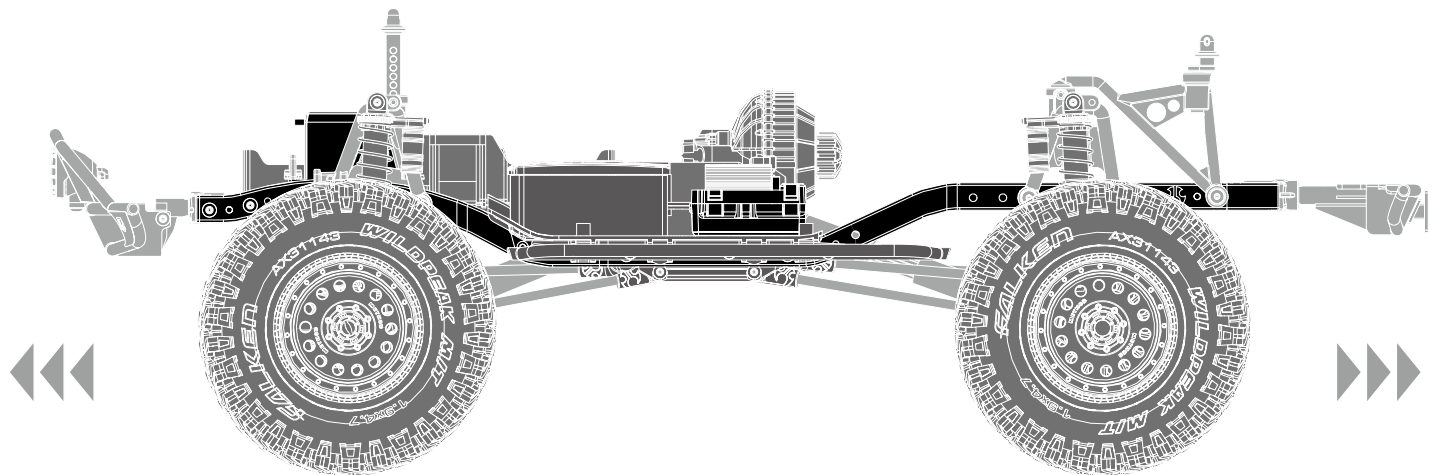
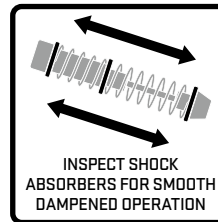
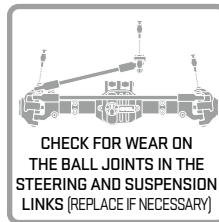
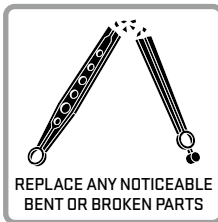



# Battery Tray



**AX31373**  
M2.6x8mm **x3**

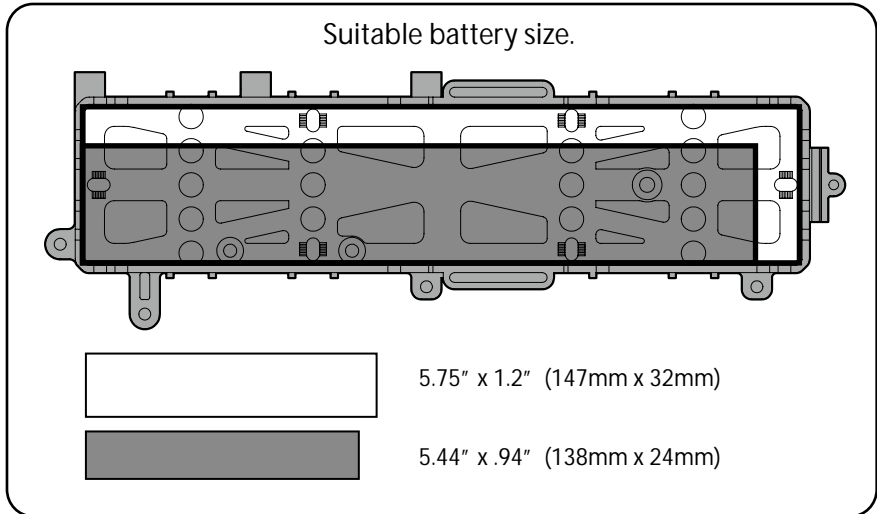
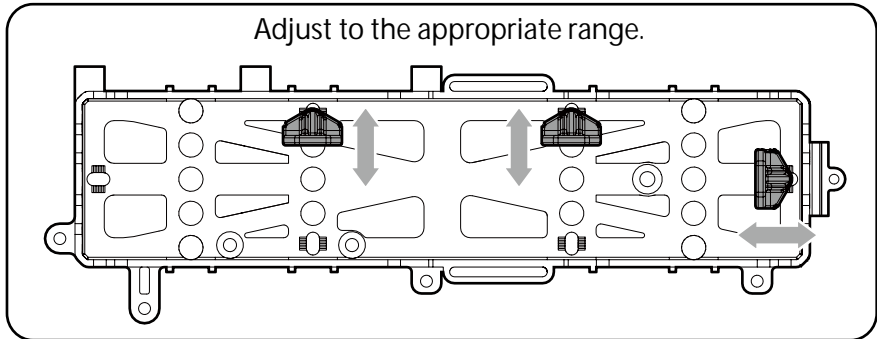
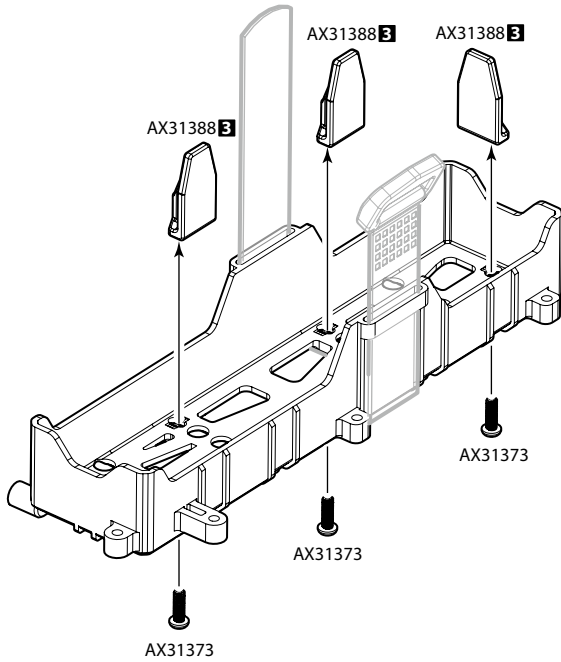

# Gear Ratio / Getriebeübersetzung

**SCX10 II Spur/Pinion Gear Ratio Chart - LCX Transmission**

| Spur      | 12    | 13    | 14    | 15    | 16    | 17    | 18    |
|-----------|-------|-------|-------|-------|-------|-------|-------|
| <b>56</b> | 45.50 | 42.00 | 39.00 | 36.40 | 34.13 | 32.12 | 30.33 |
| <b>60</b> | 48.75 | 45.00 | 41.79 | 39.00 | 36.56 |       |       |

# AE-5L Forward/Reverse ESC w/ Drag Brake

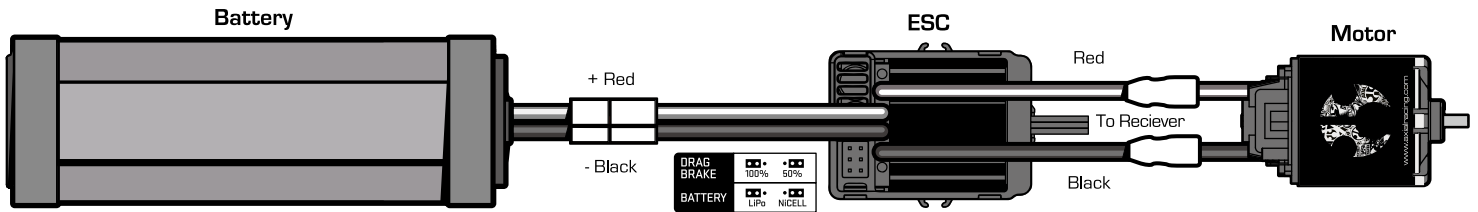

## Setup:

Throttle calibration should not be needed out-of-the-box. However in order to make the throttle range of different transmitters, the calibration of the ESC is necessary:

- Mount the ESC in an area that is well ventilated and isolated from vibration and shock.
- Connect the ESC motor wires to the motor red-red & black-black.
- Plug the receiver with into the throttle channel on the receiver. The black negative wire should be towards the outside of the receiver.
- Before plugging the battery into the ESC, make sure your transmitter is on and the throttle trim is set at zero.
- Connect the battery to the ESC, this will turn on the ESC.
- Test forward and reverse control using the transmitter.
- To calibrate the ESC, make sure the transmitter is on and the throttle control is at neutral.
- Connect the battery to the ESC and wait 3 seconds to let the ESC initiate a self-test and automatic throttle calibration. When the ESC is ready to run a long beep sound will be emitted from the motor. Always disconnect the battery when the vehicle is not in use.
- Connecting the 2 LED wires to the ESC. The wires should color match.

## Notes:

- Drag Brake set to 100% from the factory.
- LiPo Cut-Off is set to "ON" from the factory.

## Specifications:

|                            |                                |
|----------------------------|--------------------------------|
| <b>Input Voltage:</b>      | 2-3S LiPo, 5-9 Cells NiMH/NiCd |
| <b>Size:</b>               | 46.5mm x 34mm x 28.5mm         |
| <b>Weight:</b>             | 70g                            |
| <b>Motor Limit:</b>        | 12T 2S / 18T 3S                |
| <b>On-Resistance FET:</b>  | .002                           |
| <b>Rated/Peak Current:</b> | 180A                           |
| <b>Braking Current:</b>    | 90A                            |
| <b>BEC Voltage/A:</b>      | 6.0V 3.0A Peak                 |
| <b>PWM Frequency:</b>      | 1KHz                           |

## Beep Sound and LED Status:

|                       |  |
|-----------------------|--|
| <b>1 Short Beep:</b>  | Battery is NiMH/NiCd   |
| <b>2 Short Beeps:</b> | Battery is 2S Lipo   |
| <b>3 Short Beeps:</b> | Battery is 3S Lipo   |
| <b>1 Long Beep:</b>   | Self-test and throttle calibration is OK and ESC is ready to run |



**CONNECT THE BATTERY PACK JUST BEFORE DRIVING AND DISCONNECT IT IMMEDIATELY AFTER. ALWAYS MAKE SURE YOU ARE CONNECTING THE ESC TO A PROPER POWER SOURCE THAT HAS THE CORRECT VOLTAGE & POLARITY. INCORRECT VOLTAGES OR REVERSED POLARITY WILL DAMAGE THE ESC. ONCE THE BATTERY PACK IS CONNECTED, HANDLE THE MODEL WITH EXTREME CARE, MAKE SURE YOU ARE CLEAR OF ALL ROTATING PARTS.**

## 2 LED White Light String

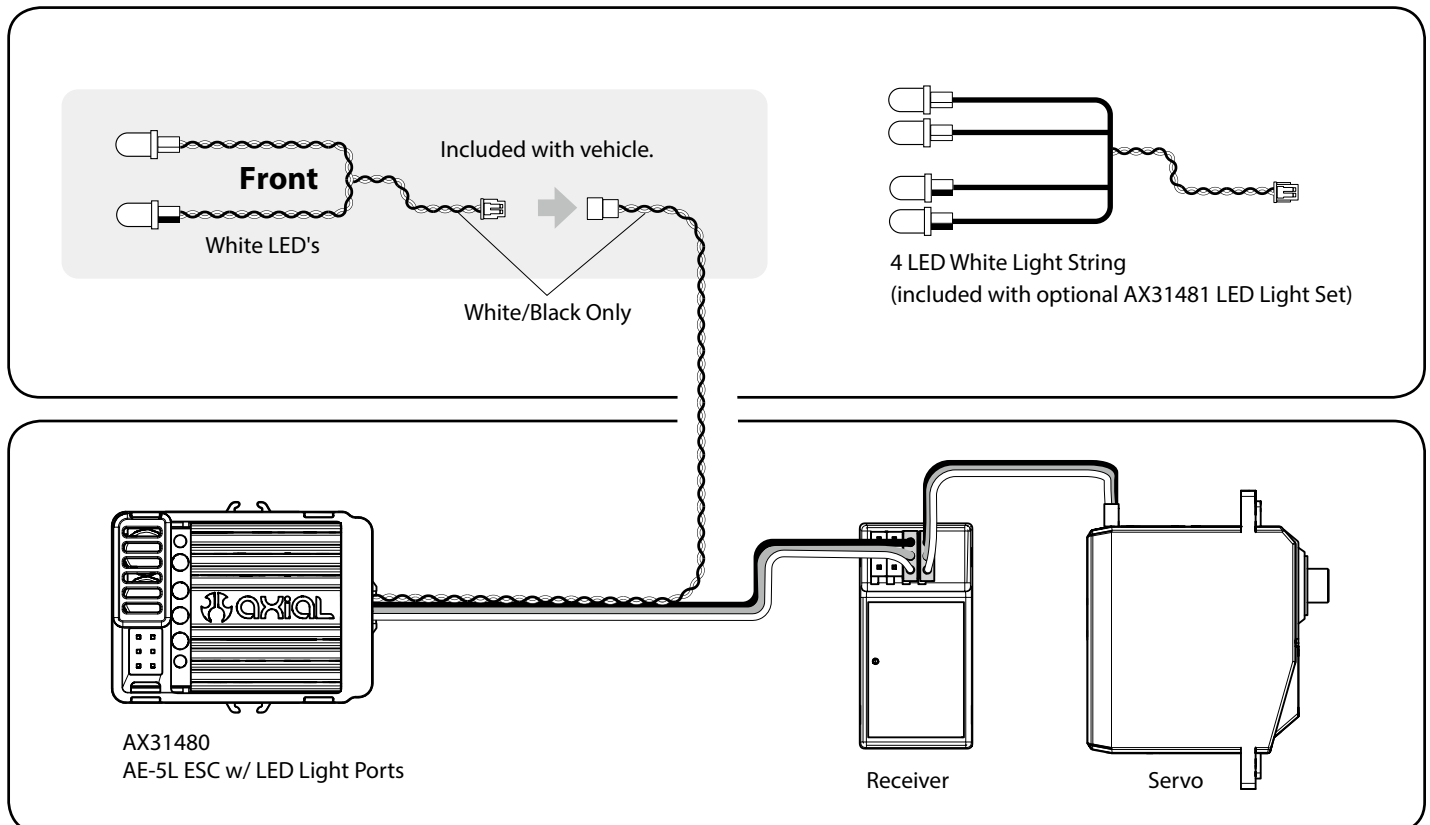

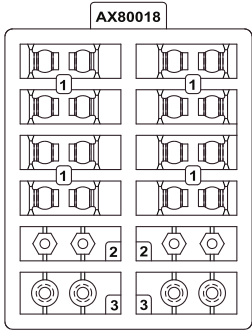

**AX80018**  
Hardware Parts Tree **x2**

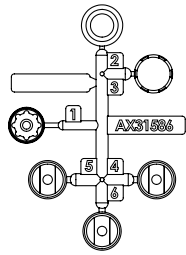

**AX31586**  
WB8-HD Standard Driveshaft **x2**

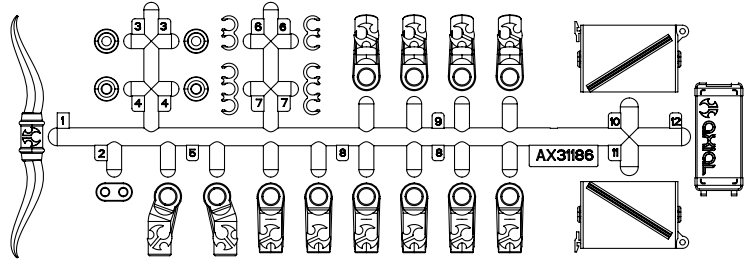

**AX31186**  
M4 Rod End Set **x3**

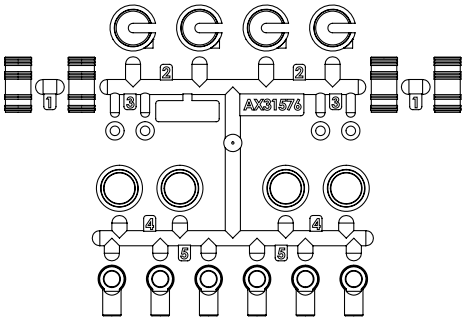

**AX31576**  
Shock Parts Tree **x1**

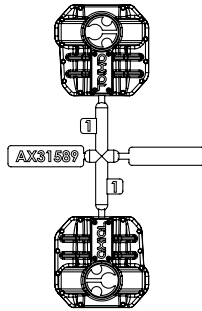

**AX31589**  
AR44 Differential Covers (Red) **x1**

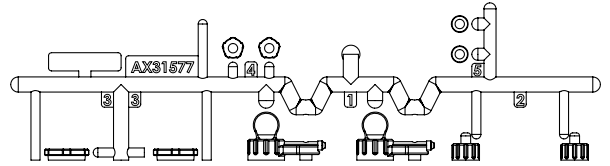

**AX31577**  
Shock Cap Parts Tree **x2**

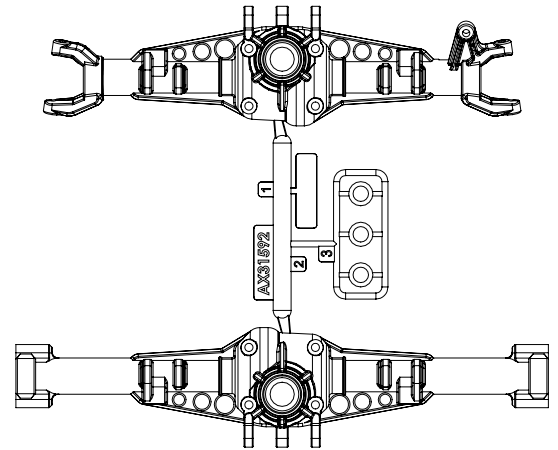

**AX31592**  
AR44 Solid Axle Housing (Front and Rear) **x1**

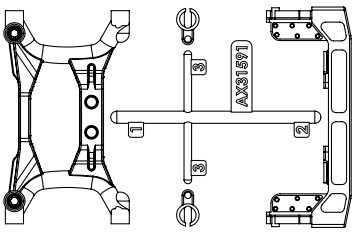

**AX31591**  
Chassis Brace Set **x1**

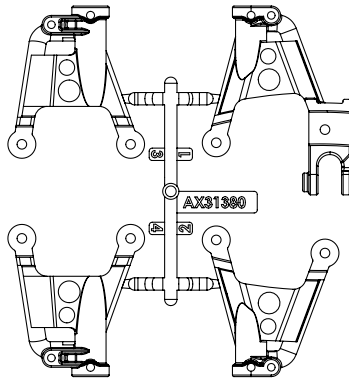

**AX31380**  
SCX10 II Shock Hoops **x1**

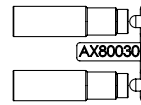

**AX80030**  
61-90mm Shock Body **x2**

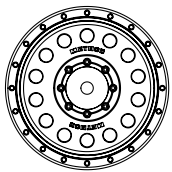

**AX31600**  
1.9 Method MR307 Hole Wheel - 26mm wide **x4**

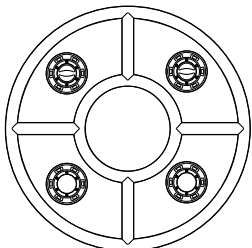

**AX8080**  
Hub Cover Set - Satin Chrome **x1**

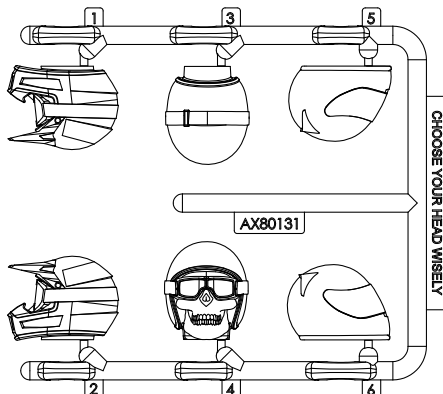

**AX80131**  
Helmets **x1**

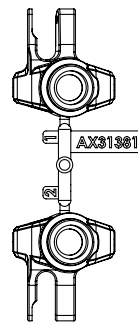

**AX31381**  
AR44 Steering Knuckles **x1**

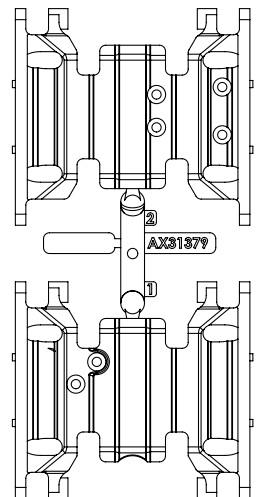

**AX31379**  
SCX10 II Skid Plates **x1**

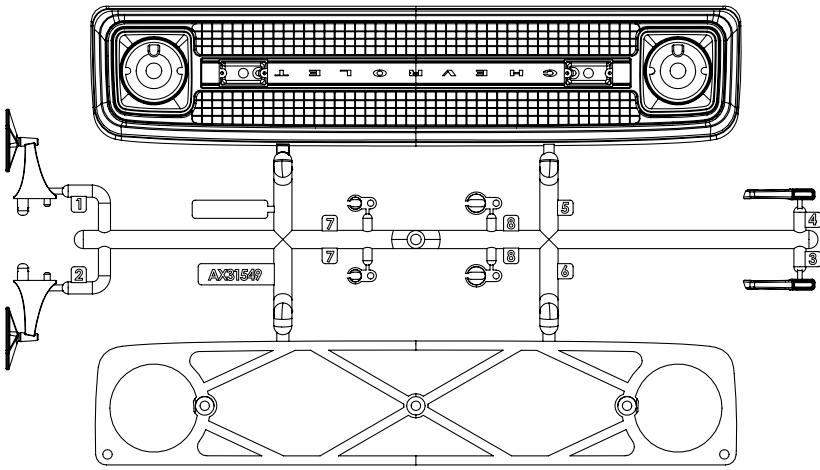

**AX31549**  
1969 Chevrolet K5 Grille and body details **x1**

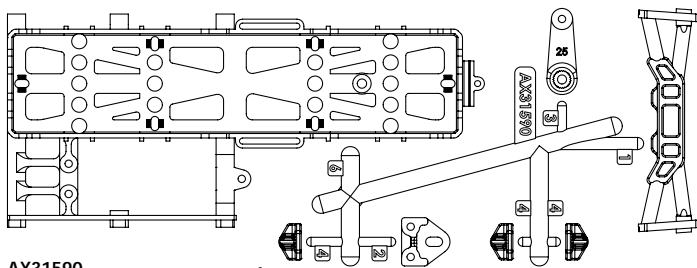

**AX31590**  
Battery Tray and Servo Mount Set **x1**

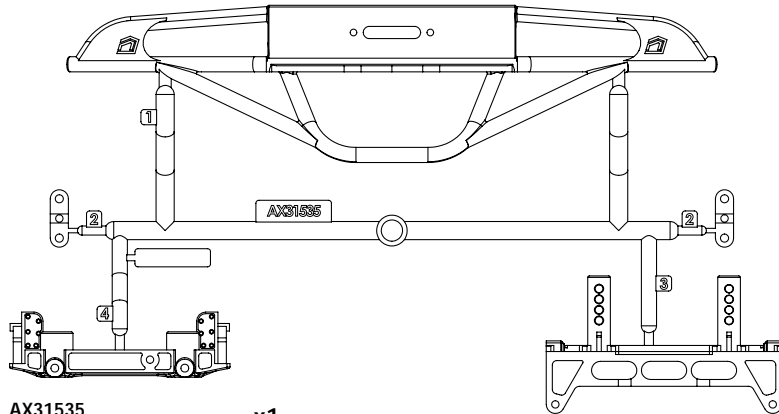

**AX31535**  
Chassis Unlimited K5 Front Bumper **x1**

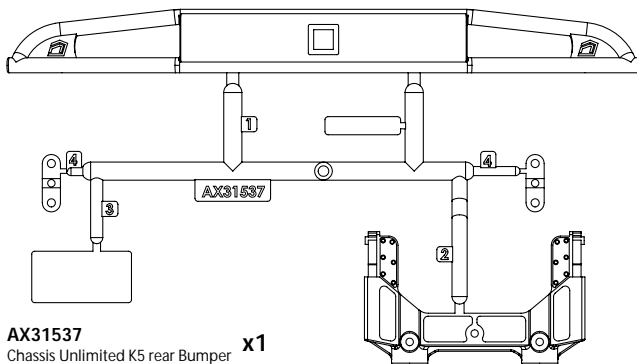

**AX31537**  
Chassis Unlimited K5 rear Bumper **x1**

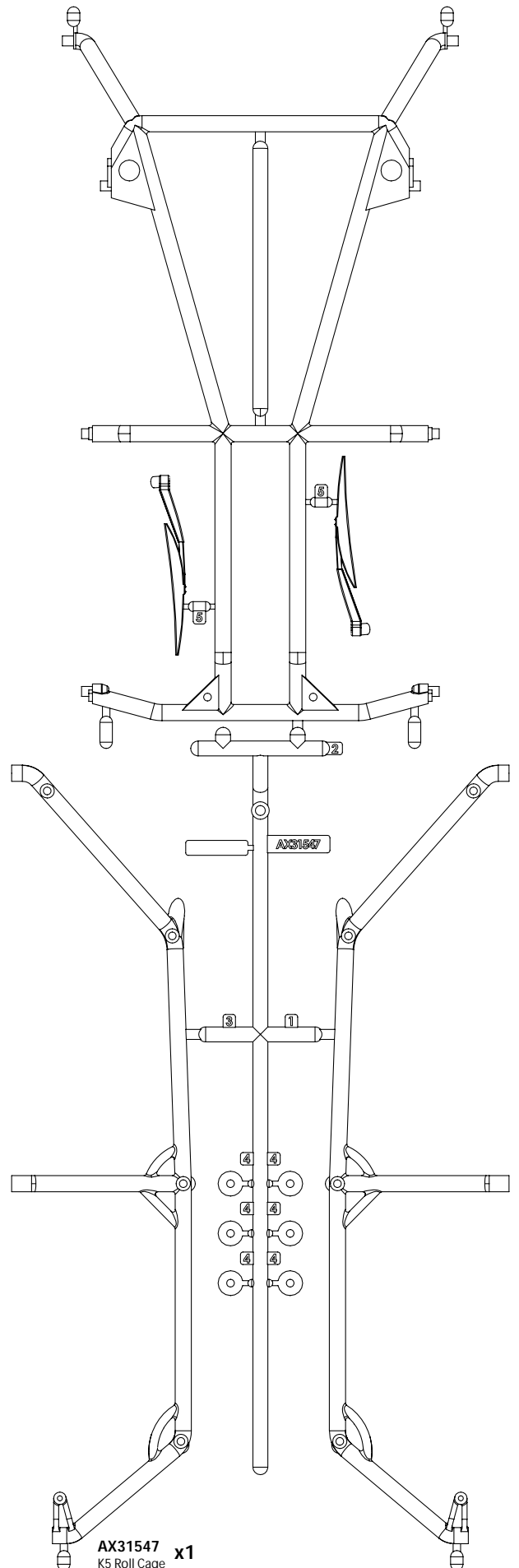

**AX31547**  
K5 Roll Cage **x1**

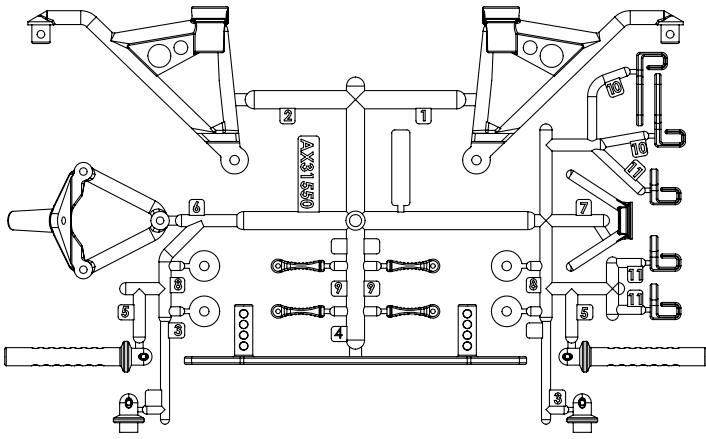

**AX31550**  
SCX10 II Rear Body Mount System **x1**

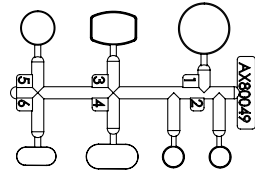

**AX80049**  
LED Lens Set - Clear **x2**

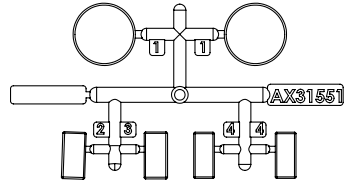

**AX31551**  
Chevrolet K5/C10 Lens set **x1**

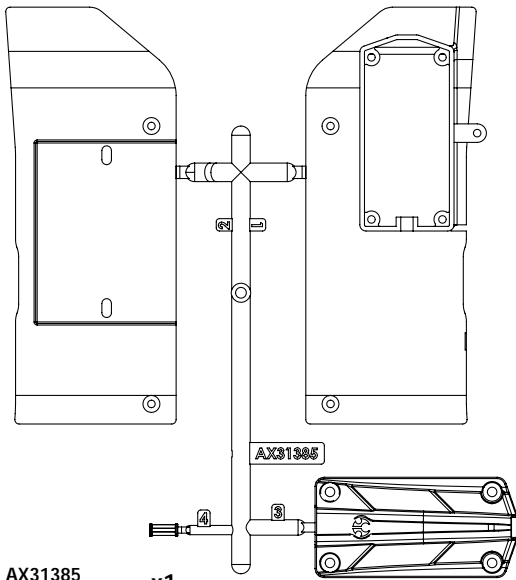

**AX31385**  
SCX10 II Side Plates **x1**

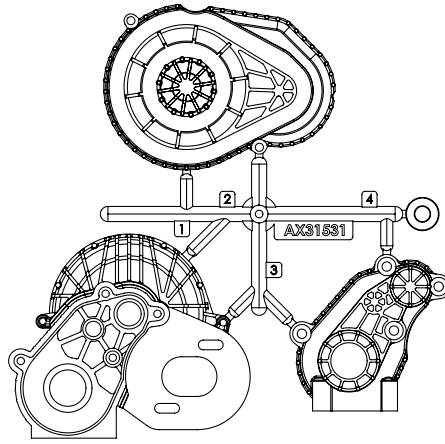

**AX31531**  
LCX Transmission Case (Silver) **x1**

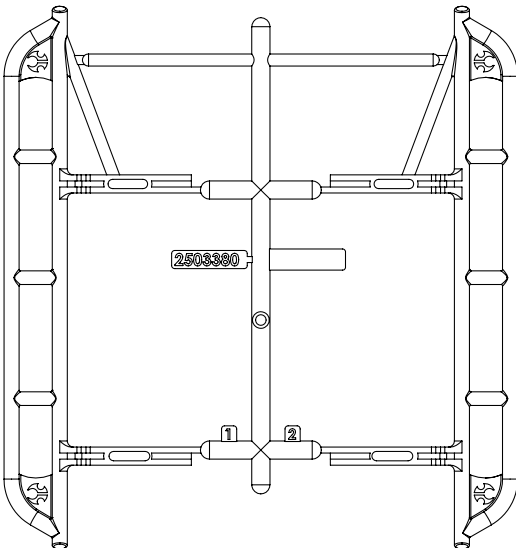

**AX31548**  
Rock sliders 12" WB **x1**

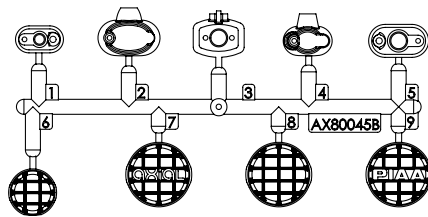

**AX80045**  
Light Bucket Set (Black) **x2**

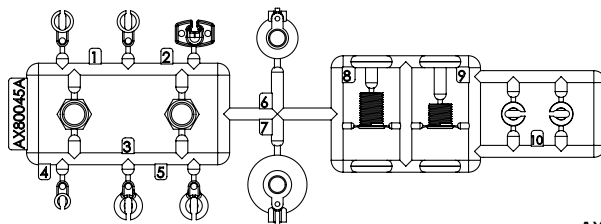

**AX80045**  
Light Bucket Set **x2**

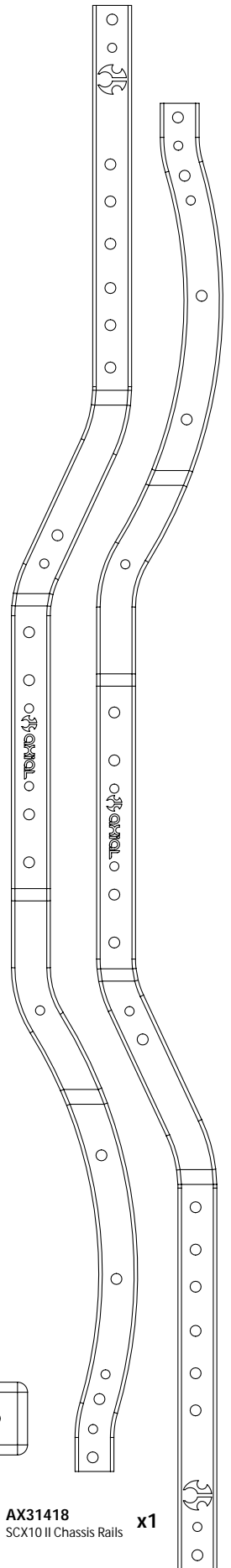

**AX31418**  
SCX10 II Chassis Rails **x1**



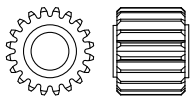

**AX30394**  
20T Drive Gear **x1**



**AX30413**  
Slipper spring 8.5x12 **x1**

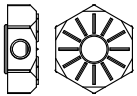

**AX31148**  
WB8-HD Driveshaft Coupler Set **x4**

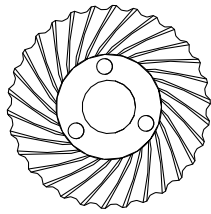
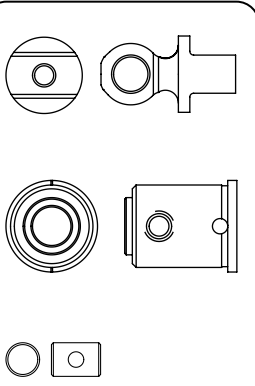

**AX31405**  
Heavy Duty Bevel Gear Set  
30T/8T **x2**

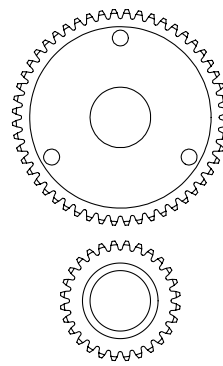
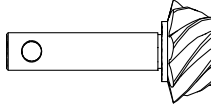

**AX31585**  
Gear Set  
(48P 28T, 48P 52T) **x1**

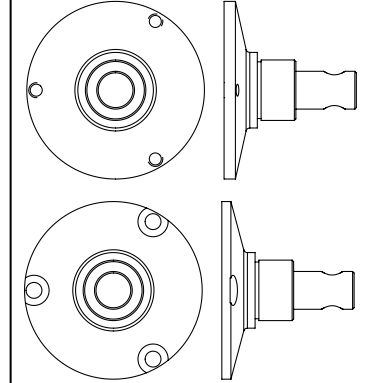

**AX30435**  
Steel Outdrive Shaft **x1**

**AX30427**  
Narrow 12mm Aluminum Hub **x4**

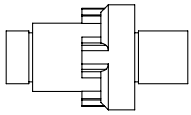

**AX31404**  
AR44 Differential Locker **x2**

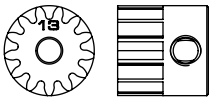

**AX30724**  
Pinion Gear 32P 13T **x1**

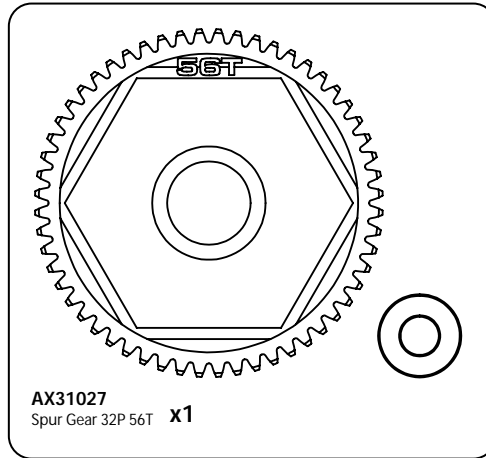

**AX31027**  
Spur Gear 32P 56T **x1**

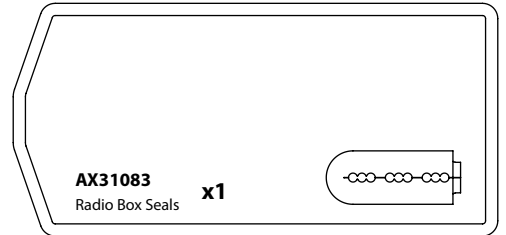

**AX31083**  
Radio Box Seals **x1**

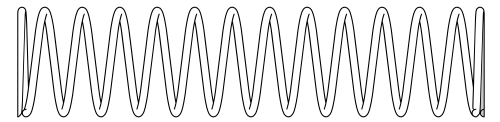

**AX31145**  
Spring 12.5x60mm 2.63 lbs/in - (Yellow) **x2**

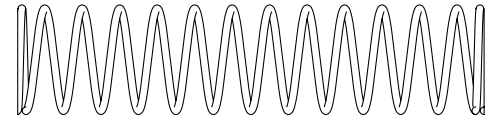

**AX31441**  
Spring 12.5x60mm 1.13lbs/in - (White) **x2**

**AX30146**  
Shock Shaft 3x50mm **x4**

**AX31539**  
Slipper Drive Gear Shaft **x1**

**AX31408**  
AR44 Straight Axle Shaft 5x106mm **x2**

**AX31402**  
AR44 Universal Axle Set **x2**

**AX31468**  
M4x80mm Steel Links **x2**

**AX31473**  
M4x92mm Steel Links **x1**

**AX31469**  
M4x103mm Steel Links **x2**

**AX31558**  
M4x106.5mm Steel Turnbuckle **x2**

**AX31557**  
M4x117mm Steel Turnbuckle **x2**



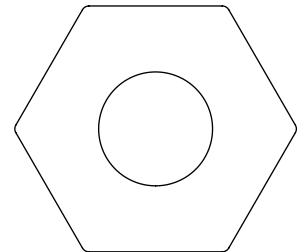



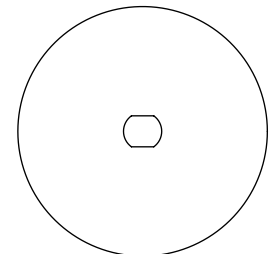























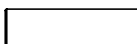

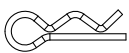

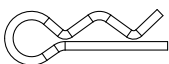

**AX31467**  
M4x128mm Steel Links **x1**



**AX31068**  
Slipper Pad **x2**

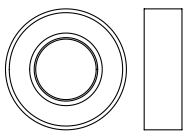
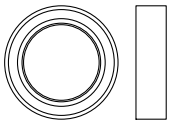
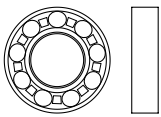
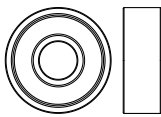

**AX31026**  
Slipper Plate **x2**

|   |                                      |            |   |   |            |   |   |            |
|---|--------------------------------------|------------|---|---|------------|---|---|------------|
|     | <b>AXA1392</b><br>E2 e-clip          | <b>x8</b>  |     | <b>AXA180</b><br>M3x3mm Set Screw                                 | <b>x4</b>  |     | <b>AXA0109</b><br>M3x10mm Oversized Flat Hex Socket       | <b>x10</b> |
|    | <b>AXA1070</b><br>Washer 3x6x0.5mm   | <b>x1</b>  |    | <b>AXA291</b><br>M4x4mm Set Screw                                 | <b>x1</b>  |    | <b>AXA013</b><br>M2x6mm Hex Socket Cap Head               | <b>x13</b> |
|    | <b>AXA1179</b><br>O-Ring 2.5x1.5mm   | <b>x12</b> |    | <b>AXA0286</b><br>Screw Shaft M4x12mm                             | <b>x15</b> |    | <b>AX31066</b><br>M2x8mm Hex Socket Cap Head              | <b>x6</b>  |
|    | <b>AXA1163</b><br>O-Ring 7x1mm       | <b>x4</b>  |    | <b>AX31403</b><br>M3x4x10mm Hex Socket Button Head Shoulder Screw | <b>x4</b>  |    | <b>AXA0023</b><br>M2.6x8mm Cap Head                       | <b>x2</b>  |
|    | <b>AX30162</b><br>Pin 1.5x8mm        | <b>x1</b>  |    | <b>AX31373</b><br>M2.6x8mm Hex Socket Button Head                 | <b>x5</b>  |    | <b>AX31399</b><br>M2.6x18mm Hex Socket Cap Head           | <b>x8</b>  |
|    | <b>AX30163</b><br>Pin 2x10mm         | <b>x4</b>  |    | <b>AXA0113</b><br>M3x6mm Hex Socket Button Head                   | <b>x5</b>  |    | <b>AXA144</b><br>M3x8mm Hex Socket Flat Head              | <b>x7</b>  |
|    | <b>AX31028</b><br>PIN 2.0 x11        | <b>x4</b>  |    | <b>AXA114</b><br>M3x8mm Hex Socket Button Head                    | <b>x9</b>  |    | <b>AX31120</b><br>M3x10mm Hex Socket Flat Head            | <b>x4</b>  |
|    | <b>AX30190</b><br>Shaft 5x18         | <b>x1</b>  |  | <b>AXA115</b><br>M3x10mm Hex Socket Button Head                   | <b>x21</b> |  | <b>AXA146</b><br>M3x12mm Hex Socket Flat Head             | <b>x14</b> |
|    | <b>AX31374</b><br>4mm Body Clip      | <b>x4</b>  |  | <b>AXA116</b><br>M3x12mm Hex Socket Button Head                   | <b>x9</b>  |  | <b>AXA148</b><br>M3x18mm Hex Socket Flat Head             | <b>x4</b>  |
|    | <b>AXA1059</b><br>6mm Body Clip      | <b>x4</b>  |  | <b>AXA117</b><br>M3x15mm Hex Socket Button Head                   | <b>x19</b> |  | <b>AXA0422</b><br>M2.6x6mm Hex Socket Tapping Button Head | <b>x2</b>  |
|   | <b>AXA1053</b><br>M3 Nylon Lock Nut  | <b>x1</b>  |  | <b>AXA118</b><br>M3x18mm Hex Socket Button Head                   | <b>x3</b>  |  | <b>AXA423</b><br>M2.6x8mm Hex Socket Tapping Button Head  | <b>x2</b>  |
|  | <b>AXA1045</b><br>M4 Nylon Lock Nut  | <b>x5</b>  |  | <b>AXA119</b><br>M3x20mm Hex Socket Button Head                   | <b>x1</b>  |   |   |            |
|  | <b>AXA1218</b><br>Bearing 5x10x4mm   | <b>x4</b>  |  | <b>AXA120</b><br>M3x25mm Hex Socket Button Head                   | <b>x2</b>  |   |   |            |
|  | <b>AXA1221</b><br>Bearing 5x11x4mm   | <b>x8</b>  |  | <b>AXA121</b><br>M3x30mm Hex Socket Button Head                   | <b>x1</b>  |   |   |            |
|  | <b>AXA1225</b><br>Bearing 8x16x5mm   | <b>x2</b>  |   |   |            |   |   |            |
|  | <b>AXA1230</b><br>Bearing 10x15x4mm  | <b>x2</b>  |   |   |            |   |   |            |
|  | <b>AX31406</b><br>Bearing 7x14x3.5mm | <b>x4</b>  |   |   |            |   |   |            |
|  | <b>AX31407</b><br>Bearing 5x14x5mm   | <b>x2</b>  |   |   |            |   |   |            |















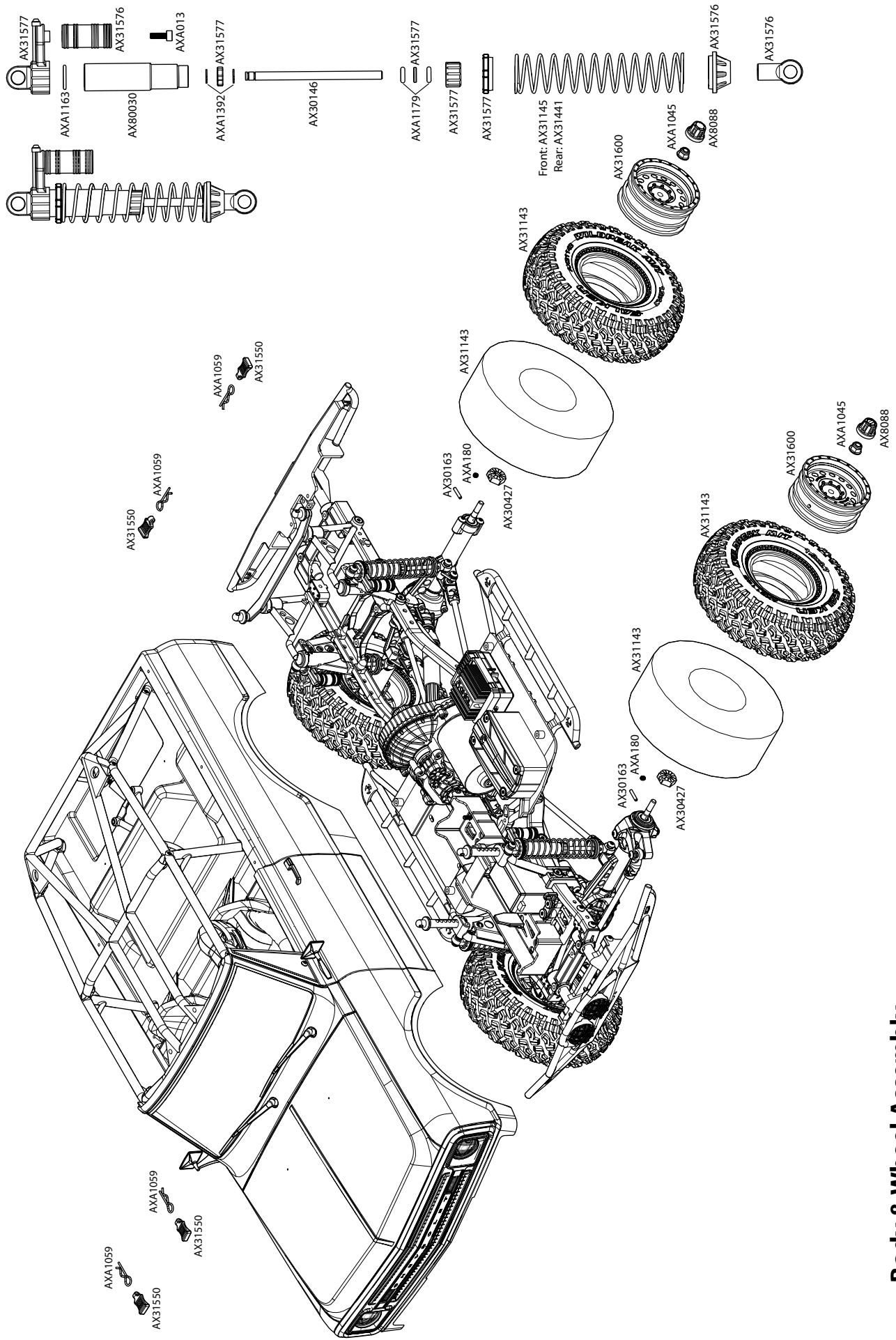

Body & Wheel Assembly



# Details Install



**AXA013**  
M2x6mm Hex Socket Cap Head **x4**

**1**

\* LED Lights not included

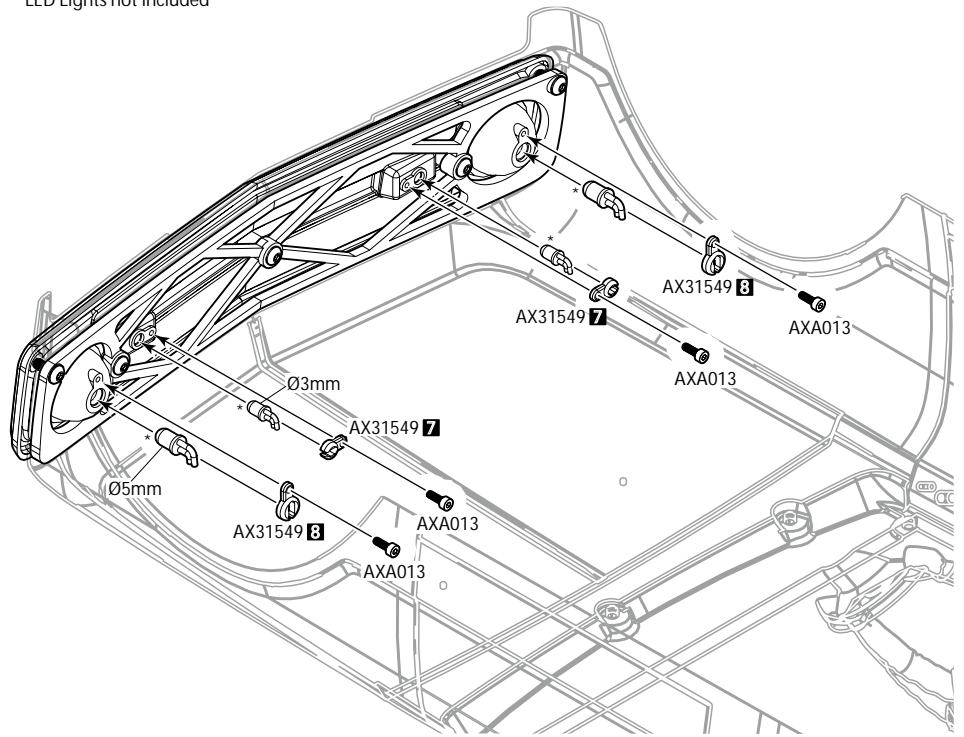

**AXA115**  
M3x10mm Hex Socket Button Head **x3**



**AXA121**  
M3x30mm Hex Socket Button Head **x1**

**2**

\* Trail and Wheels not included

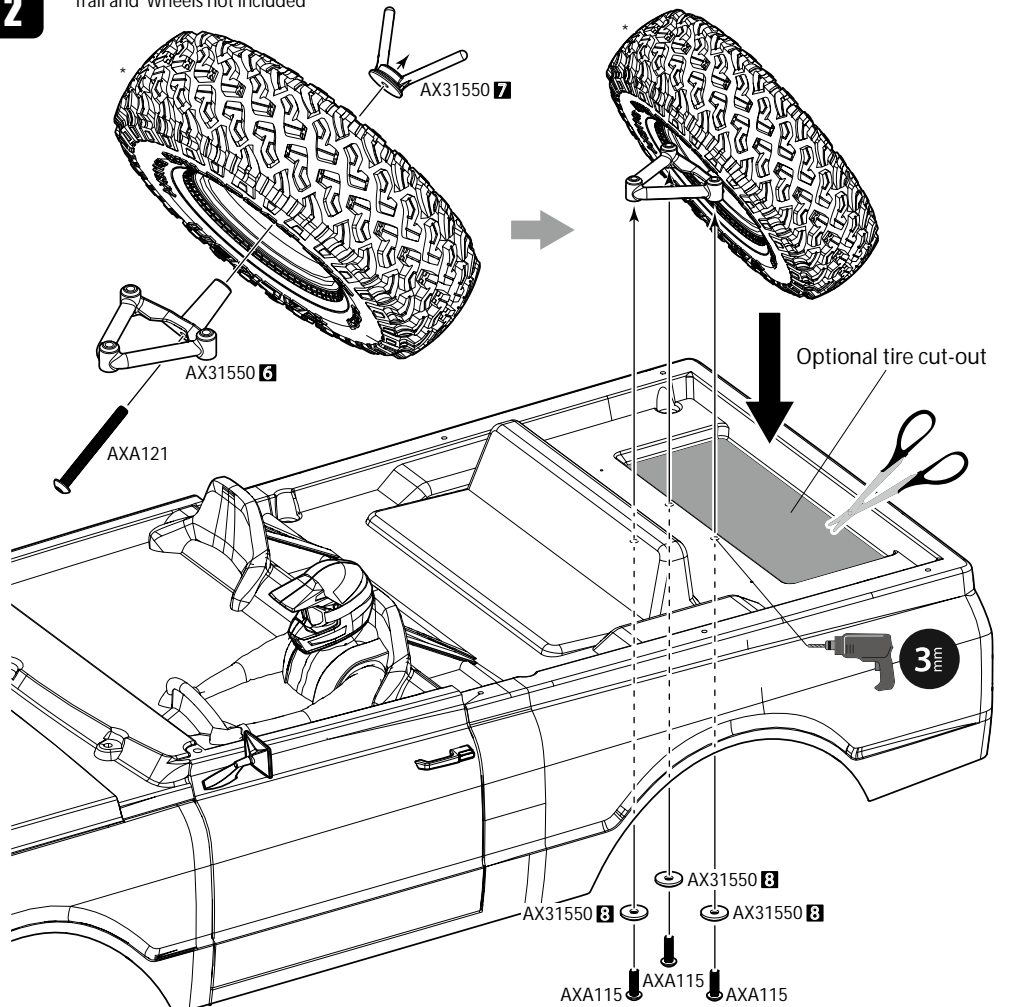



## Parts List

| Part #  | Description  | Part #  | Description                                       |
|---------|--|---------|---|
| AX30041 | Hook and Loop Strap 15x160mm                                 | AXA0023 | M2.6x8mm Cap Head (Black) (10pcs)                 |
| AX30146 | Shock Shaft 3x50 (2pcs)                                      | AXA0109 | M3x10mm Oversized Flat Hex Socket (Black) (10pcs) |
| AX30162 | Pin 1.5x8mm (6pcs.)  | AXA0113 | M3x6mm Hex Socket Button Head (Black) (10pcs)     |
| AX30163 | Pin 2.0x10mm (6pcs.)   | AXA013  | M2x6 mm Cap Head (Black) (10pcs)                  |
| AX30166 | Pin 1.5x11mm (6pcs)  | AXA0286 | Screw Shaft M4x2.5x12mm (6pcs)                    |
| AX30190 | Shaft 5x18 (2pcs.)   | AXA1045 | M4 Nylon Lock Nut (Black) (10pcs)                 |
| AX30394 | 20T Drive Gear   | AXA1053 | M3 Nylon Locking Hex Nut (Black) (10pcs)          |
| AX30413 | Slipper spring 8.5x12 165 lbs/in - Black (2pcs)              | AXA1059 | 6mm Body clip (Black) (10pcs)                     |
| AX30427 | Narrow 12mm Aluminum Hub - Black (4pcs)                      | AXA1070 | Washer 3x6x0.5 (10pcs)                            |
| AX30435 | Steel Outdrive Shaft Set (2pcs)                              | AXA114  | M3x8mm Hex Socket Button Head (Black) (10pcs)     |
| AX30724 | Pinion Gear 32P 13T (3mm shaft)                              | AXA115  | M3x10mm Hex Socket Button Head (Black) (10pcs)    |
| AX31026 | Slipper Plate Washer 33x5x1.5mm (2pcs)                       | AXA1163 | O-Ring 7x1mm (10pcs)                              |
| AX31027 | Spur Gear 32P 56T  | AXA117  | M3x15mm Hex Socket Button Head (Black) (10pcs)    |
| AX31028 | Pin 2.0x11mm (6pcs)  | AXA1179 | O-Ring 2.5x1.5mm (10pcs)                          |
| AX31068 | Slipper Pad 32.8x15.2x1mm (2pcs)                             | AXA118  | M3x18mm Hex Socket Button Head - Black (10pcs)    |
| AX31083 | Radio Box Seals  | AXA119  | M3x20mm Hex Socket Button Head (Black) (10pcs)    |
| AX31120 | M3x10mm Hex Socket Flat Head (Black) (10pcs)                 | AXA120  | M3x25mm Hex Socket Button Head (Black) (10pcs)    |
| AX31143 | 1.9 Falken Wildpeak M/T - R35 Compound (2pcs)                | AXA121  | M3x30mm Hex Socket Button Head (Black) (10pcs)    |
| AX31145 | Spring 12.5x60mm 2.63 lbs/in - Medium (Grey) (2pcs)          | AXA1218 | Bearing 5x10x4mm (2pcs)                           |
| AX31148 | WB8-HD Driveshaft Coupler Set                                | AXA1221 | Bearing 5x11x4mm (2pcs)                           |
| AX31186 | M4 Rod End Set   | AXA1225 | Bearing 8x16x5mm (2pcs)                           |
| AX31312 | 35T Electric Motor   | AXA1230 | Bearing 10x15x4mm                                 |
| AX31373 | M2.6x8mm Hex Socket Button Head (Black) (10pcs)              | AXA1392 | E2 e-clip (10pcs)                                 |
| AX31374 | 3mm Body Clip (Black) (10pcs)                                | AXA144  | M3x8mm Hex Socket Flat Head (Black) (10pcs)       |
| AX31379 | SCX10 II Skid Plates   | AXA146  | M3x12mm Hex Socket Flat Head - Black (10pcs)      |
| AX31380 | SCX10 II Shock Hoops   | AXA148  | M3x18mm Hex Socket Flat Head (Black) (10pcs)      |
| AX31381 | AR44 Steering Knuckles                                       | AXA180  | M3x3mm Set Screw (Black) (10pcs)                  |
| AX31385 | SCX10 II Side Plates   | AXA291  | M4x4mm Set Screw (Black) (6pcs.)                  |
| AX31399 | M2.6x18mm Cap Head (Black) (10pcs)                           |         |   |
| AX31402 | AR44 Universle Axle Set (2pcs)                               |         |   |
| AX31403 | M3x4x10mm Hex Socket Button Head Shoulder Screw(Black)(6pcs) |         |   |
| AX31404 | AR44 Differential Locker                                     |         |   |
| AX31405 | Heavy Duty Bevel Gear Set - 30T/8T                           |         |   |
| AX31406 | Bearing 7x14x3.5mm (2pcs)                                    |         |   |
| AX31407 | Bearing 5x14x5mm (2pcs)                                      |         |   |
| AX31408 | AR44 Straight Axle Shaft 5x106mm (2pcs)                      |         |   |
| AX31418 | SCX10 II Chassis Rails (2pcs)                                |         |   |
| AX31441 | Spring 12.5x60mm 1.13 lbs/in - (White) (2pcs)                |         |   |
| AX31467 | M4x128mm Steel Links (2pcs)                                  |         |   |
| AX31468 | M4x80mm Steel Links (2pcs)                                   |         |   |
| AX31469 | M4x103mm Steel Links (2pcs)                                  |         |   |
| AX31473 | M4x92mm Steel Links (2pcs)                                   |         |   |
| AX31480 | AE-5L ESC w/LED Ports and Lights (2 White, 4 White, 2 Red)   |         |   |
| AX31481 | AE-5L LED Light Set (2 White, 4 White, 2 Red)                |         |   |
| AX31531 | LCX Transmission Case (Silver)                               |         |   |
| AX31535 | Chassis Unlimited K5 Front Bumper                            |         |   |
| AX31537 | Chassis Unlimited K5 Rear Bumper                             |         |   |
| AX31539 | Slipper Drive Gear Shaft 5x56.5mm                            |         |   |
| AX31547 | K5 Blazer Roll Cage  |         |   |
| AX31548 | Rock Sliders (12.0" WB)                                      |         |   |
| AX31549 | 1969 Chevrolet K5 Blazer Grille and Body Details             |         |   |
| AX31550 | SCX10 II Rear Body Post Set                                  |         |   |
| AX31551 | Chevrolet K5/C10 Lens Set (Clear)                            |         |   |
| AX31554 | 1969 Chevrolet K5 Blazer Body - .040" Uncut (Clear)          |         |   |
| AX31557 | M4x117mm Steel Links (2pcs)                                  |         |   |
| AX31558 | M4x106.5mm Steel Links (2pcs)                                |         |   |
| AX31576 | Shock Parts  |         |   |
| AX31577 | Shock Caps   |         |   |
| AX31585 | Gear Set (48P 28T, 48P 52T)                                  |         |   |
| AX31586 | WB8-HD Standard Driveshaft                                   |         |   |
| AX31589 | AR44 Differential Covers (Red)                               |         |   |
| AX31590 | Battery Tray and Servo Mount Set                             |         |   |
| AX31591 | Chassis Brace Set  |         |   |
| AX31592 | AR44 Solid Axle Housing (Front and Rear)                     |         |   |
| AX31600 | 1.9 Method MR307 Hole Wheels - Magnesium/Chrome (2pcs)       |         |   |
| AX80018 | Hardware Parts Tree  |         |   |
| AX80030 | 61-90 Schock Body Set  |         |   |
| AX80045 | Light Bucket Set (Black)                                     |         |   |
| AX80049 | LED Lens Set - Yellow/Clear (4pcs)                           |         |   |
| AX80131 | Helmet Set   |         |   |
| AX8080  | Hub Cover Set - Satin Chrome (4pcs)                          |         |   |

## Option Parts

| Part #  | Description  | Part #  | Description  |
|---------|--|---------|--|
| AX04032 | AX10 Ridgcrest Body - .040" (Clear)  | AX31578 | 2017 Jeep® Wrangler Unlimited Rubicon Hardtop Body - .050" (Clear) |
| AX04033 | 2012 Jeep Wrangler Unlimited Rubicon™ Body-.040"(Clear)-Body Only          | AX31585 | Gear Set (48P 28T, 48P 52T)  |
| AX04035 | 2012 Jeep Wrangler Unlimited Rubicon™ Body-.040"(Clear)-Complete           | AX31587 | 1.9 KMC XD Machete Crawl Wheels - Black (2pcs)                     |
| AX04038 | Jeep® Wrangler Rock Racer Body - .040" (Clear) - Body Only                 | AX4010  | Dingo Truck Body - .040" uncut (Clear)                             |
| AX04039 | AX10 Deadbolt Body - .040" (Clear) - Body Only                             | AX4025  | Trail Honcho Truck Body - .040" uncut (Clear) w/Molded Rear Cage   |
| AX04040 | Jeep®WranglerWraith-Poison Spyder Rock Racer Body-.040"(Pre-painted & Cut) | AX80047 | Interior Details Parts Tree - Chrome                               |
| AX08138 | 1.9 Walker Evans Street Wheel - Black (2pcs)                               | AX80048 | Exterior Detail Parts Tree - Chrome                                |
| AX08140 | 1.9 Walker Evans Street Wheel - Chrome/Black (2pcs)                        | AX80051 | Dig Transmission Case  |
| AX12016 | 1.9 Ripsaw Tires - R35 Compound (2pcs)                                     | AX80128 | Wheel Hub Adapters (2pcs Narrow, 2pcs Wide)                        |
| AX12019 | 1.9 Maxxis Trepador Tires - R35 Compound (2pcs)                            | AX8080  | Axial Hub Cover Set - Satin Chrome (4pcs)                          |
| AX24003 | 20T Electric Motor   | AX8087  | Axial 1.9 8 Hole Beadlocks - Black (2pcs)                          |
| AX24004 | 27T Electric Motor   | AX8088  | Axial 1.9 8 Hole Beadlocks - Satin Chrome (2pcs)                   |
| AX24007 | Axial 55T Electric Motor   | AXA1046 | M4 Serrated Nylon Lock Nut (Blue) (4pcs)                           |
| AX24251 | Axial NVS - Night Visions System   | AXA1076 | Cap Head Washer M3x10mm (4pcs)                                     |
| AX24257 | Simple LED Controller w/LED lights (4 white and 2 Red)                     | AXA1105 | Cone Washer 3x6.9x2mm - Grey (6pcs)                                |
| AX30090 | Axial 61-90mm Aluminum Shock Set - 7mm Piston (2pcs)                       | AXA1331 | Flanged Ball 3x5.8x7mm (6pcs)                                      |
| AX30103 | Icon 61-90mm Aluminum Shock Set - 7mm piston (2pcs)                        |         |  |
| AX30114 | Axial Hard Anodized Aluminum Shock Reservoir (2pcs)                        |         |  |
| AX30115 | Axial Hard Anodized Aluminum Pre-load collar (2pcs)                        |         |  |
| AX30117 | Axial Hard Anodized Aluminum Shock Body 10x38mm (2pcs)                     |         |  |
| AX30130 | Icon Clear Anodized Aluminum Shock Body 10x38mm (2pcs)                     |         |  |
| AX30131 | Icon Clear Anodized Aluminum Shock Reservoir (2pcs)                        |         |  |
| AX30132 | Machined Shock Piston 7mm - 1.5x3 (4pcs)                                   |         |  |
| AX30201 | Spring 12.5x20mm 4.32 lbs/in - Soft (White) - (2pcs)                       |         |  |
| AX30202 | Spring 12.5x20mm 5.44 lbs/in - Medium (Green) - (2pcs)                     |         |  |
| AX30203 | Spring 12.5x20mm 6.53 lbs/in - Firm (Yellow) - (2pcs)                      |         |  |
| AX30204 | Spring 12.5x20mm 7.95 lbs/in - Super Firm (Blue) - (2pcs)                  |         |  |
| AX30205 | Spring 12.5x40mm 2.7 lbs/in - Super Soft (Red) - (2pcs)                    |         |  |
| AX30206 | Spring 12.5x40mm 3.6 lbs/in - Soft (White) - (2pcs)                        |         |  |
| AX30208 | Spring 12.5x40mm 5.44 lbs/in - Firm (Yellow) - (2pcs)                      |         |  |
| AX30209 | Spring 12.5x40mm 6.81 lbs/in - Super Firm (Blue) - (2pcs)                  |         |  |
| AX30487 | AX10 Locked Transmission Set   |         |  |
| AX30488 | AX10 Locked Axle Set   |         |  |
| AX30516 | Threaded Aluminum Pipe 6x106mm - Grey (2 pcs.)                             |         |  |
| AX30517 | Threaded Aluminum Pipe 6x33mm - Grey (2pcs.)                               |         |  |
| AX30524 | Threaded Aluminum Pipe 6x91mm - Grey (2pcs)                                |         |  |
| AX30547 | 1.9 Internal Wheel Weight Ring 43g/1.5oz (2pcs)                            |         |  |
| AX30548 | 1.9 Internal Wheel Weight Insert 9g/0.33oz(4pcs)(for use with AX30547)     |         |  |
| AX30708 | AX10 Locked Transmission-Complete Metal Gear Set-Steel(3pcs)               |         |  |
| AX30709 | Universal 5 Bucket Light Bar Set   |         |  |
| AX30793 | Dig Component Set  |         |  |
| AX30794 | WB8 Driveshaft Set (2pcs)  |         |  |
| AX30834 | Aluminum Servo Horn 23T  |         |  |
| AX30835 | Aluminum Servo Horn 24T  |         |  |
| AX30836 | Aluminum Servo Horn 25T  |         |  |
| AX31093 | 1.9 BFGoodrich Krawler T/A - R35 Compound (2pcs)                           |         |  |
| AX31094 | 1.9 Black Rock CRC Wheels - Black (2pcs)                                   |         |  |
| AX31097 | 3 Port High Output LED Controller  |         |  |
| AX31144 | AE-5 Waterproof Forward/Reverse ESC w/Drag Brake                           |         |  |
| AX31150 | SCX10 Wheel Wells - .040_ (Clear)  |         |  |
| AX31152 | Universal Rigid Light Bar Set  |         |  |
| AX31176 | Spawn Body - .040" (Clear)   |         |  |
| AX31250 | M4 Serrated Nylon Lock Nut (Black) (10pcs)                                 |         |  |
| AX31267 | Jeep® NuKizer 715 Body - .040" (Clear)                                     |         |  |
| AX31268 | Jeep® Mighty FC Body - .040" (Clear)                                       |         |  |
| AX31329 | 35T Trail Breaker Electric Motor (Rebuildable)                             |         |  |
| AX31330 | 55T Trail Breaker Electric Motor (Rebuildable)                             |         |  |
| AX31337 | 2000 Jeep® Cherokee Body - .040" (Clear) - Body Only                       |         |  |
| AX31395 | JCROffroad Roof Rack   |         |  |
| AX31405 | Heavy Duty Bevel Gear Set - 30T/8T   |         |  |
| AX31412 | 1.9 BFGoodrich All-Terrain T/A KO2 - R35 Compound (2pcs)                   |         |  |
| AX31415 | 1.9 Method Mesh Wheels - Black (2pcs)                                      |         |  |
| AX31438 | AR44 Locked Axle Set (Front or Rear) Complete                              |         |  |
| AX31439 | SCX10 Transmission Set (Complete)  |         |  |
| AX31442 | Spring 12.5x60mm 3.03 lbs/in - (Blue) (2pcs)                               |         |  |
| AX31443 | Spring 12.5x60mm 1.70 lbs/in - (Green) (2pcs)                              |         |  |
| AX31444 | Spring 12.5x60mm 0.70 lbs/in - (Red) (2pcs)                                |         |  |
| AX31465 | SCX10 II Front Links Set (Aluminum)  |         |  |
| AX31466 | SCX10 II Rear Links Set (80mm, 94mm, 101.5mm) (Aluminum)                   |         |  |
| AX31570 | CRC JK Rear Bumper   |         |  |
| AX31571 | CRC JK Front Bumper  |         |  |

OFFICIALLY LICENSED TECHNICAL PARTNERS:



## EXPLORE

[facebook.com/axialinc](https://facebook.com/axialinc) | [instagram.com/axialracing](https://instagram.com/axialracing) | [twitter.com/axialrc](https://twitter.com/axialrc)  
[youtube.com/axialvideos](https://youtube.com/axialvideos) | [flickr.com/axialrc](https://flickr.com/axialrc)



General Motors Trademarks used under license to Axial R/C Inc.  
PIAA® is a registered trademark of PIAA® corporation.

©2018 Axial R/C, Inc. A subsidiary of Horizon Hobby, LLC. All Rights Reserved.  
1608 Interstate Drive, Champaign, IL 61822

AX90058-1001  
8810060