



25- to 46-Size Electric Retract Instructions

NOTICE

All instructions, warranties and other collateral documents are subject to change at the sole discretion of Horizon Hobby, Inc. For up-to-date product literature, visit <http://www.horizonhobby.com> and click on the support tab for this product.

Meaning of Special Language:

The following terms are used throughout the product literature to indicate various levels of potential harm when operating this product:

WARNING: Procedures, which if not properly followed, create the likely probability of physical property damage AND may lead to a dangerous condition or cause death or serious injury to the user, OR procedures, which if not followed, create the high probability of superficial injury.

WARNING: Read the ENTIRE instruction manual to become familiar with the features of the product before operating. Failure to operate the product correctly can result in damage to the product, personal property and cause serious injury.

This is a sophisticated hobby product and NOT a toy. It must be operated with caution and common sense and requires some basic mechanical ability. Failure to operate this Product in a safe and responsible manner could result in injury or damage to the product or other property. This product is not intended for use by children without direct adult supervision. Do not attempt to disassemble, use with incompatible components or augment product in any way without the approval of Horizon Hobby, Inc. This manual contains instructions for safety, operation and maintenance. It is essential to read and follow all the instructions and warnings in the manual, prior to assembly, setup or use, in order to operate correctly and avoid damage or serious injury.

Thank you for purchasing the E-flite® 25- to 46-Size Electric Retracts. These self-contained units are powered from your model's receiver and do not require separate servos.

The retracts are supplied with coil struts installed, plus adjustable axles, wheel collars, Allen wrenches and a 3-into-1 wire harness (for the tricycle set) or 2-into-1 wire harness (for main gear set). The nose gear unit is steerable and has a slot in the sliding steering arm to prevent binding of the steering cable when retracted.

EFLG300, EFLG310, EFLG320

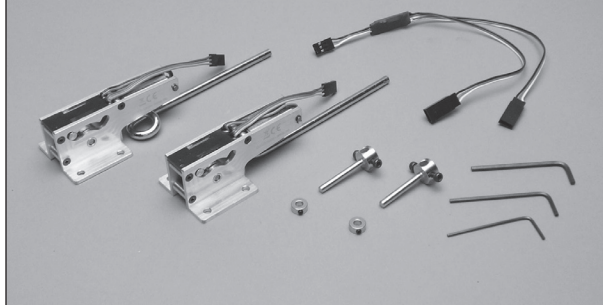

EFLG330

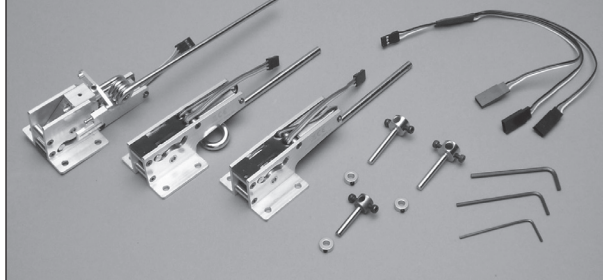

Specifications

Current draw

Idle: 5mA
Operating: 900mA (maximum)

Pulse width trigger points

Down: 1.331ms
Up: 1.690ms

Operation with FM and DSM

FM: 22ms frame rate,
5V signal
DSM: 20ms frame rate,
3.3V signal

Sequence time

@4.8V 2.75sec
@6.0V 2.50sec
@7.4V 2.25sec

Operating voltage range

4.8—7.4V

Aircraft weight

5.00—9.50 lb (2.25—4.30 kg)

Unit weight

Nose gear: 3.5 oz (99.5 g)
Main gear: 2.8 oz (79.5 g) each

Parts Available

EFLG30190	90-degree Main Retract Unit
EFLG30185	85-degree Main Retract Unit
EFLG301100L	100-degree Left Rotating Main Unit
EFLG301100R	100-degree Right Rotating Main Unit
EFLG302	Left Main Wire Strut
EFLG303	Right Main Wire Strut
EFLG304	Adjustable Axles
EFLRYH9	Dual Plug Y-harness
EFLG31190	90-degree Nose Retract Unit
EFLG311105	105-degree Nose Retract Unit
EFLG312	Nose Gear Wire Strut
EFLG313	Nose Gear Steering Arm
EFLRYH9TR	Triple Plug Y-harness

Tools Required

- Pencil
- Flat file
- Safety glasses
- 1.5mm, 2mm, 2.5mm hex wrenches
- Screwdriver
- Threadlock
- Rotary tool with cutoff wheel

Installation

1. Use a 2mm hex wrench to remove the pair of setscrews retaining the strut in each main gear trunnion. Apply threadlock to the setscrews and reinstall them.

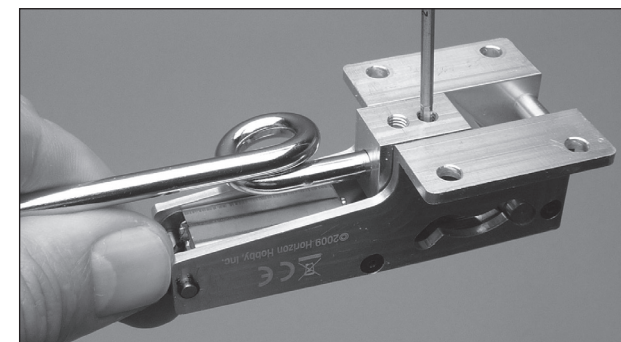

2. Test fit the retract unit in the wing or fuselage to determine the strut length and axle location. Cut the strut to length using a cutoff wheel in a rotary tool.



3. Make two flat spots on the end of the strut with a file and use a 2.5mm hex wrench to secure the axle to the strut. Apply threadlock to the threads of the retaining screws so they do not loosen from vibration.

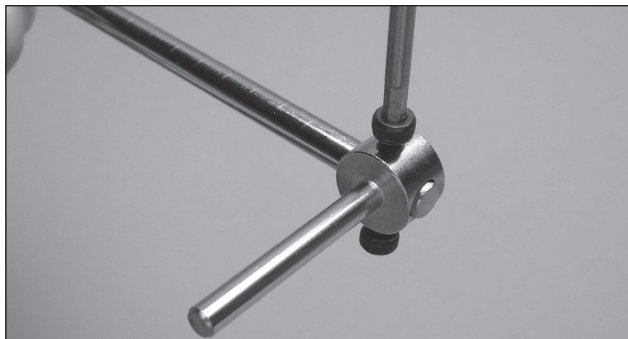
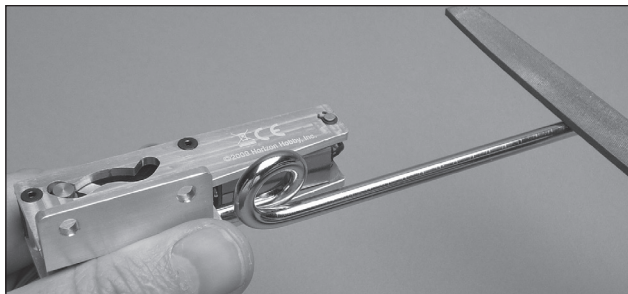

4. Install the wheels on the axles. Slide the brass wheel collar onto the axle and secure it using a 1.5mm hex wrench. Apply threadlock to the setscrew to prevent it loosening due to vibration.

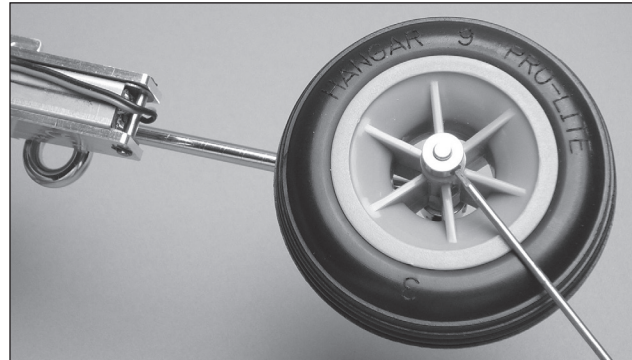

5. Mark the retract mounting hole locations on the rails using a pencil and drill appropriately sized holes for the hardware you intend to use.

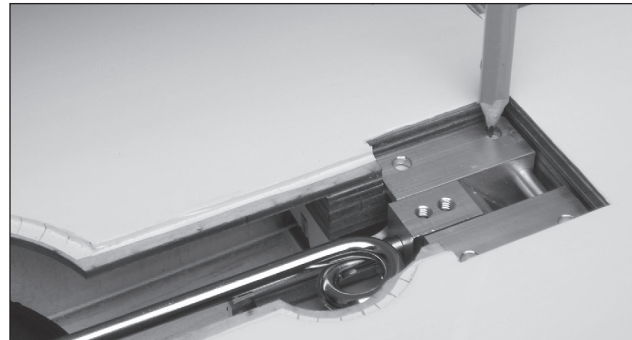

6. Install the retracts in the model using the screws provided with the kit or those of your own choice. A #4 x 1/2-inch wood screw works well.

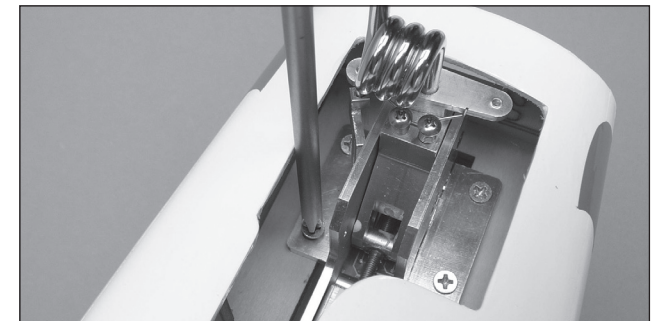
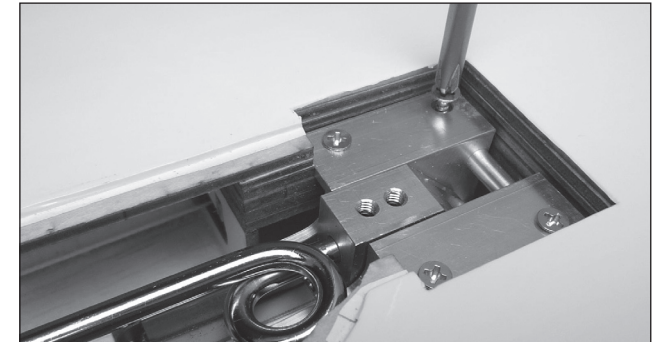

Nosegear Steering

Connect the steering pushrod clevis to the steering arm on the nosegear.

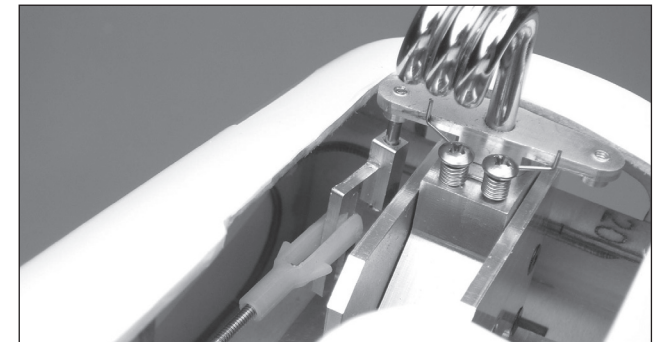

Radio Connections and Operation

1. Plug the connector from each of the retract units into the 3-into-1 wire harness supplied with the retracts.

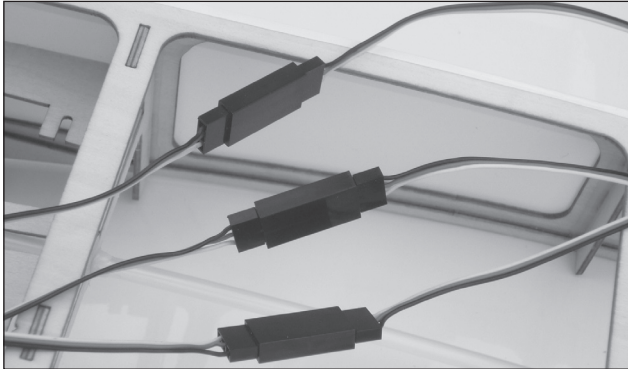

2. Plug the single lead from the wire harness into the gear channel of your receiver. An auxiliary channel can be used if the gear channel is occupied.

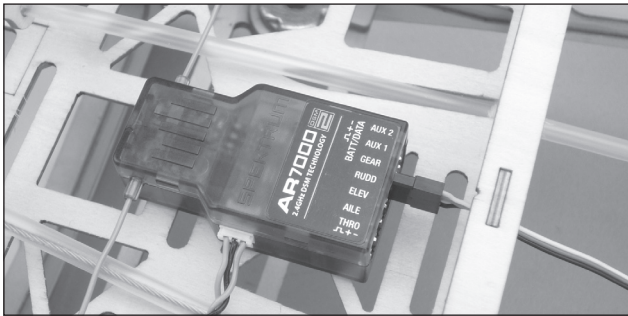

3. Before operating the retracts in the model for the first time check that there are no obstructions in the wheel wells that could impede operation of the gear.
4. Turn on your transmitter and receiver. Use the gear or other assigned switch to activate the landing gear and check that it operates correctly.
5. If the switch direction is opposite of that desired, use the reversing function in the transmitter to change the retraction direction.
6. If using a 2.4GHz radio, once you have set the correct servo direction be sure to rebind the system before flight.

Warranty and Repair Policy

Warranty Period: Exclusive Warranty- Horizon Hobby, Inc., (Horizon) warranties that the Products purchased (the "Product") will be free from defects in materials and workmanship for a period of 1 year from the date of purchase by the Purchaser.

Limited Warranty: Horizon reserves the right to change or modify this warranty without notice and disclaims all other warranties, express or implied.

(a) This warranty is limited to the original Purchaser ("Purchaser") and is not transferable. REPAIR OR REPLACEMENT AS PROVIDED UNDER THIS WARRANTY IS THE EXCLUSIVE REMEDY OF THE PURCHASER. This warranty covers only those Products purchased from an authorized Horizon dealer. Third party transactions are not covered by this warranty. Proof of purchase is required for all warranty claims.

(b) Limitations- HORIZON MAKES NO WARRANTY OR REPRESENTATION, EXPRESS OR IMPLIED, ABOUT NON-INFRINGEMENT, MERCHANTABILITY OR FITNESS FOR A PARTICULAR PURPOSE OF THE PRODUCT. THE PURCHASER ACKNOWLEDGES THAT THEY ALONE HAVE DETERMINED THAT THE PRODUCT WILL SUITABLY MEET THE REQUIREMENTS OF THE PURCHASER'S INTENDED USE.

(c) Purchaser Remedy- Horizon's sole obligation hereunder shall be that Horizon will, at its option, (i) repair or (ii) replace, any Product determined by Horizon to be defective. In the event of a defect, these are the Purchaser's exclusive remedies. Horizon reserves the right to inspect any and all equipment involved in a warranty claim. Repair or replacement decisions are at the sole discretion of Horizon. This warranty does not cover cosmetic damage or damage due to acts of God, accident, misuse, abuse, negligence, commercial use, or modification of or to any part of the Product. This warranty does not cover damage due to improper installation, operation, maintenance, or attempted repair by anyone other than Horizon. Return of any Product by Purchaser must be approved in writing by Horizon before shipment.

Damage Limits: HORIZON SHALL NOT BE LIABLE FOR SPECIAL, INDIRECT OR CONSEQUENTIAL DAMAGES, LOSS OF PROFITS OR PRODUCTION OR COMMERCIAL LOSS IN ANY WAY CONNECTED WITH THE PRODUCT, WHETHER SUCH CLAIM IS BASED IN CONTRACT, WARRANTY, NEGLIGENCE, OR STRICT LIABILITY. Further, in no event shall the liability of Horizon exceed the individual price of the Product on which liability is asserted. As Horizon has no control over use, setup, final assembly, modification or misuse, no liability shall be assumed nor accepted for any resulting damage or injury. By the act of use, setup or assembly, the user accepts all resulting liability.

If you as the Purchaser or user are not prepared to accept the liability associated with the use of this Product, you are advised to return this Product immediately in new and unused condition to the place of purchase.

Law: These Terms are governed by Illinois law (without regard to conflict of law principals).

Warranty Services

Questions, Assistance, and Repairs: Your local hobby store and/or place of purchase cannot provide warranty support or repair. Once assembly, setup or use of the Product has been started, you must contact Horizon directly. This will enable Horizon to better answer your questions and service you in the event that you may need any assistance. For questions or assistance, please direct your email to productsupport@horizonhobby.com, or call 877.504.0233 toll free to speak to a Product Support representative. You may also find information on our website at www.horizonhobby.com.

Inspection or Repairs: If this Product needs to be inspected or repaired, please use the Horizon Online Repair Request submission process found on our website or call Horizon to obtain a Return Merchandise Authorization (RMA) number. Pack the Product securely using a shipping carton. Please note that original boxes may be included, but are not designed to withstand the rigors of shipping without additional protection. Ship via a carrier that provides tracking and insurance for lost or damaged parcels, as Horizon is not responsible for merchandise until it arrives and is accepted at our facility. An Online Repair Request is available at www.horizonhobby.com <http://www.horizonhobby.com> under the Repairs tab. If you do not have internet access, please contact Horizon Product Support to obtain a RMA number along with instructions for submitting your product for repair. When calling Horizon, you will be asked to provide your complete name, street address, email address and phone number where you can be reached during business hours. When sending product into Horizon, please include your RMA number, a list of the included items, and a brief summary of the problem. A copy of your original sales receipt must be included for warranty consideration. Be sure your name, address, and RMA number are clearly written on the outside of the shipping carton.

Notice: Do not ship batteries to Horizon. If you have any issue with a battery, please contact the appropriate Horizon Product Support office.

Warranty Inspection and Repairs: To receive warranty service, you must include your original sales receipt verifying the proof-of-purchase date. Provided warranty conditions have been met, your Product will be repaired or replaced free of charge. Repair or replacement decisions are at the sole discretion of Horizon.

Non-Warranty Repairs: Should your repair not be covered by warranty the repair will be completed and payment will be required without notification or estimate of the expense unless the expense exceeds 50% of the retail purchase cost. By submitting the item for repair you are agreeing to payment

of the repair without notification. Repair estimates are available upon request. You must include this request with your repair. Non-warranty repair estimates will be billed a minimum of ½ hour of labor. In addition you will be billed for return freight. Horizon accepts money orders and cashiers checks, as well as Visa, MasterCard, American Express, and Discover cards. By submitting any item to Horizon for inspection or repair, you are agreeing to Horizon's Terms and Conditions found on our website under the Repairs tab.

Electronics and engines:

Horizon Service Center
4105 Fieldstone Rd.
Champaign, Illinois
61822 USA
877-504-0233
productsupport@horizonhobby.com

All other products:

Horizon Service Center
4105 Fieldstone Rd.
Champaign, Illinois
61822 USA
877-504-0233
productsupport@horizonhobby.com

Horizon Hobby Limited

Units 1-4 Ployters Rd
Staple Tye
Harlow, Essex
CM18 7NS
United Kingdom
+44 (0) 1279 641 097
sales@horizonhobby.co.uk

Horizon Technischer Service

Hamburger Str. 10
25335 Elmshorn
Germany
+49 4121 46199 66
service@horizonhobby.de

Horizon Hobby SAS

14 Rue Gustave Eiffel
Zone d'Activité du Réveil Matin
91230 Montgeron
+33 (0) 1 60 47 44 70

Compliance Information for the European Union

CE Declaration of Conformity
(in accordance with ISO/IEC 17050-1)

No. HH2010093005

Product(s): 25-46 size Electric Retracts
Item Number(s): EFLG300, EFLG310, EFLG320, EFLG330

The object of declaration described above is in conformity with the requirements of the specifications listed below, following the provisions of the European EMC Directive 2004/108/EC:

EN55014-1 Electromagnetic compatibility - Emission
EN55014-2 Electromagnetic compatibility - Immunity

Signed for and on behalf of:
Horizon Hobby, Inc.
Champaign, IL USA
September 30, 2010



Steven A. Hall
Vice President
International Operations and Risk Management
Horizon Hobby, Inc.



Instructions for Disposal of WEEE by Users in the European Union

This product must not be disposed of with other waste. Instead, it is the user's responsibility to dispose of their waste equipment by handing it over to a designated collection point for the recycling of waste electrical and electronic equipment. The separate collection and recycling of your waste equipment at the time of disposal will help to conserve natural resources and ensure that it is recycled in a manner that protects human health and the environment. For more information about where you can drop off your waste equipment for recycling, please contact your local city office, your household waste disposal service or where you purchased the product.



© 2010 Horizon Hobby, Inc.
E-flite is a registered trademark of Horizon Hobby, Inc.
PRC patent ZL 200920061135.3

Created 09/2010

28419