



# DX5R

5-Channel 2.4GHz DSMR® System



**Instruction Manual**  
**Bedienungsanleitung**  
**Manuel d'utilisation**  
**Manuale di istruzioni**

## NOTICE

All instructions, warranties and other collateral documents are subject to change at the sole discretion of Horizon Hobby, LLC. For up-to-date product literature, visit [horizonhobby.com](http://horizonhobby.com) and click on the support tab for this Product.

## MEANING OF SPECIAL LANGUAGE

The following terms are used throughout the product literature to indicate various levels of potential harm when operating this product:

**WARNING:** Procedures, which if not properly followed, create the probability of property damage, collateral damage and serious injury OR create a high probability of superficial injury.

**CAUTION:** Procedures, which if not properly followed, create the probability of physical property damage AND a possibility of serious injury.

**NOTICE:** Procedures, which if not properly followed, create a possibility of physical property damage AND little or no possibility of injury.



**WARNING:** Read the ENTIRE instruction manual to become familiar with the features of the product before operating. Failure to operate the product correctly can result in damage to the product, personal property and cause serious injury.

This is a sophisticated hobby product. It must be operated with caution and common sense and requires some basic mechanical ability. Failure to operate this product in a safe and responsible manner could result in injury or damage to the product or other property. This product is not intended for use by children without direct adult supervision. Do not attempt disassembly, use with incompatible components or augment product in any way without the approval of Horizon Hobby, LLC. This manual contains instructions for safety, operation and maintenance. It is essential to read and follow all the instructions and warnings in the manual, prior to assembly, setup or use, in order to operate correctly and avoid damage or serious injury.



### WARNING AGAINST COUNTERFEIT PRODUCTS

Always purchase from a Horizon Hobby, LLC authorized dealer to ensure authentic high-quality Spektrum product. Horizon Hobby, LLC disclaims all support and warranty with regards, but not limited to, compatibility and performance of counterfeit products or products claiming compatibility with DSM or Spektrum.

**NOTICE:** This product is only intended for use with unmanned, hobby-grade, remote-controlled vehicles and aircraft. Horizon Hobby disclaims all liability outside of the intended purpose and will not provide warranty service related thereto.

**Age Recommendation: Not for Children under 14 years. This is not a toy.**

## WARRANTY REGISTRATION

Visit [community.spektrumrc.com](http://community.spektrumrc.com) today to register your product.

## SAFETY PRECAUTIONS

- Always ensure all batteries have been properly charged prior to using the model.
- Always check all servos and their connections prior to each run.
- Never operate your model near spectators, parking areas or any other area that could result in injury to people or damage of property.
- Never operate your model during adverse weather conditions. Poor visibility can cause disorientation and loss of control of your model.
- Never point the transmitter antenna directly toward the model. The radiation pattern from the tip of the antenna is inherently low.
- If at any time during the operation of your model you observe any erratic or abnormal operation, immediately stop operation of your model until the cause of the problem has been ascertained and corrected.

# TABLE OF CONTENTS

Installing Batteries.....	4	Trims.....	18
Battery and Charging Precautions and Warnings.....	4	Sound settings.....	18
SD Card.....	5	About.....	18
Main Screen.....	7	Calibrate.....	18
Navigation.....	7	<b>System setup.....</b>	<b>19</b>
<b>Function List.....</b>	<b>8</b>	Model Select.....	19
Model Select.....	8	Model Utilities.....	19
Model Name.....	8	System setup.....	20
Servo Setup.....	9	Create new model.....	20
Rates.....	10	Delete model.....	20
Exponential.....	10	Copy model.....	20
Timer.....	10	Reset model.....	20
Binding/Frame rate.....	11	Sort model list.....	20
Bind the Transmitter to the Receiver.....	11	System setup.....	21
Failsafe.....	11	Transfer sd card.....	21
Mixing.....	12	Import model.....	21
Steer Mix.....	12	Export model.....	21
4WS (4-Wheel Steering).....	12	Update firmware.....	21
2 Servo (Dual Steering).....	12	<b>PHYSICAL TRANSMITTER ADJUSTMENTS.....</b>	<b>22</b>
Dual throttle.....	13	Changing grips.....	22
Dual Brake.....	13	Dropdown steering wheel options.....	23
Motor on axel (MOA).....	13	Rotate:.....	23
PROgrammable Mix.....	14	Standard wheel conversion:.....	23
Active Vehicle Control (AVC).....	14	steering wheel wedges (not included).....	23
Automatic Braking System (Abs).....	15	<b>Receiver Compatibility.....</b>	<b>24</b>
Idle Up.....	15	<b>Optional Parts List.....</b>	<b>24</b>
Traction.....	16	<b>1-Year Limited Warranty.....</b>	<b>25</b>
Trim setup.....	16	<b>Troubleshooting Guide.....</b>	<b>26</b>
Channel Assign.....	16	<b>Warranty and Service Contact Information.....</b>	<b>26</b>
Telemetry.....	16	<b>FCC Information.....</b>	<b>27</b>
Drive Mode.....	17	<b>IC Information.....</b>	<b>27</b>
System settings.....	17	<b>Compliance Information for the European Union.....</b>	<b>27</b>
Display.....	17		

# IDENTIFYING CONTROLS AND SWITCHES

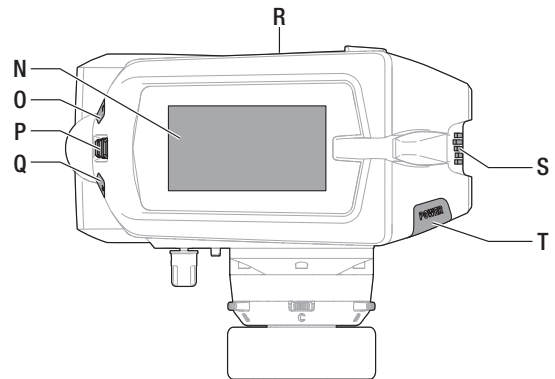
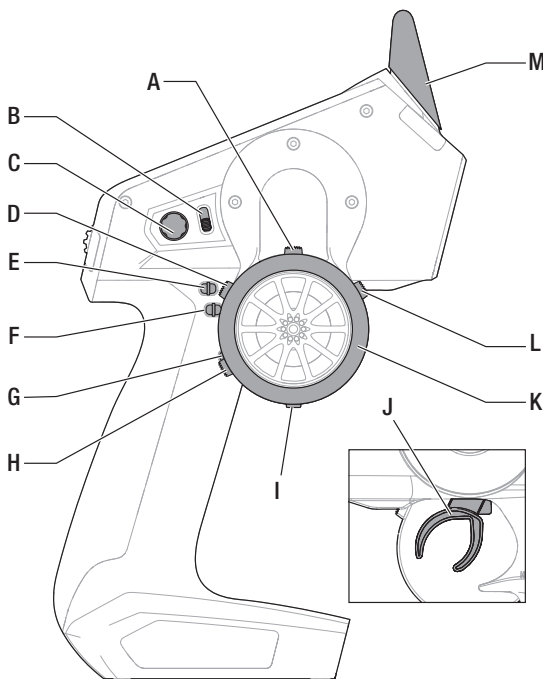

- |                                    |                          |
|------------------------------------|--------------------------|
| <b>A:</b> Button C                 | <b>L:</b> Button D       |
| <b>B:</b> Switch I                 | <b>M:</b> Antenna        |
| <b>C:</b> Knob                     | <b>N:</b> LCD Screen     |
| <b>D:</b> Button B                 | <b>O:</b> Button L       |
| <b>E:</b> Button F                 | <b>P:</b> Roller Wheel   |
| <b>F:</b> Button G                 | <b>Q:</b> Button R       |
| <b>G:</b> Button H                 | <b>R:</b> SD Card Reader |
| <b>H:</b> Button A                 | <b>S:</b> Power LED      |
| <b>I:</b> Button E                 | <b>T:</b> Power Button   |
| <b>J:</b> Trigger (throttle/brake) |                          |
| <b>K:</b> Steering Wheel           |                          |

## INSTALLING BATTERIES

1. Remove the battery cover from the bottom of the transmitter.
2. Install 4 AA batteries as shown.
3. Install the battery cover.

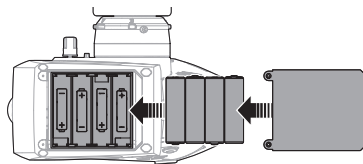

**CAUTION:** NEVER remove the transmitter batteries while the model is powered on. Loss of model control, damage or injury may occur.

### Installing Optional Lithium Ion Battery Pack

**IMPORTANT:** Set the transmitter battery type to Li-Ion in the Display/Battery menu and ensure the battery voltage alert is set to the proper voltage. See the *System* section for more details.

1. Remove the battery cover from the bottom of the transmitter.
2. Remove the AA battery holder and disconnect from the transmitter power port.
3. Connect the battery pack to the transmitter power port.
4. Install the battery pack into the transmitter.
5. Install the battery cover.

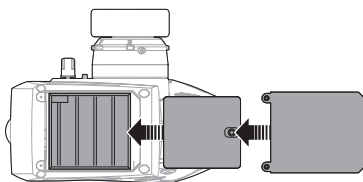

**CAUTION:** Risk of explosion if battery is replaced by an incorrect type. Dispose of used batteries according to state and local laws.

## CHARGING AND WARNINGS

Failure to exercise caution while using this product and comply with the following warnings could result in product malfunction, electrical issues, excessive heat, FIRE, and ultimately injury and property damage.

- Read all safety precautions and literature prior to use of this product
- **Never** allow minors to charge battery packs
- **Never** drop charger or batteries
- **Never** attempt to charge damaged batteries
- **Never** attempt to charge a battery pack containing different types of batteries
- **Never** charge a battery if the cable has been pinched or shorted
- **Never** allow batteries or battery packs to come into contact with moisture at any time

- **Never** charge batteries in extremely hot or cold places (recommended between 50–80° F or 10–27° C) or place in direct sunlight
- **Always** disconnect the battery after charging, and let the charger cool between charges
- **Always** inspect a new battery before charging
- **Always** terminate all processes and contact Horizon Hobby if the product malfunctions
- **Always** keep batteries and charger away from any material that could be affected by heat.
- **Always** end the charging process if the charger or battery becomes hot to the touch or starts to change form (swell) during the charge process

### CHARGING THE OPTIONAL LITHIUM ION BATTERY PACK

**NOTICE:** Only use the recommended power supply (SPM9551) with the DX5R transmitter.

Always charge the transmitter on a heat-resistant surface.

1. Power off your transmitter.
2. Connect the power supply (SPM9551) connector to the Li-Ion charge port located through the opening in the battery door.
3. Connect the power supply to a power outlet using a country specific adapter.

4. Disconnect the transmitter from the power supply once charging is complete and disconnect the power supply from the power outlet.

**CAUTION:** Never leave a charging battery unattended.

**CAUTION:** Never charge a battery overnight.

**CAUTION:** Never connect an external battery charger to the transmitter.

## MICRO SD-CARD\*

### Installing the Micro SD-Card

The Micro SD-Card (**not included**) enables you to:

- Import (copy) models from any compatible Spektrum™ RaceWare™ transmitter
- Export (transfer) models to any Spektrum RaceWare transmitter
- Update Firmware in the transmitter

To install the Micro SD-Card:

1. Power off the transmitter.
2. Install the Micro SD-Card in the card reader slot located behind the small rubber door on the side of the transmitter.

\*For more Micro SD-Card information see the Transfer SD Card section.

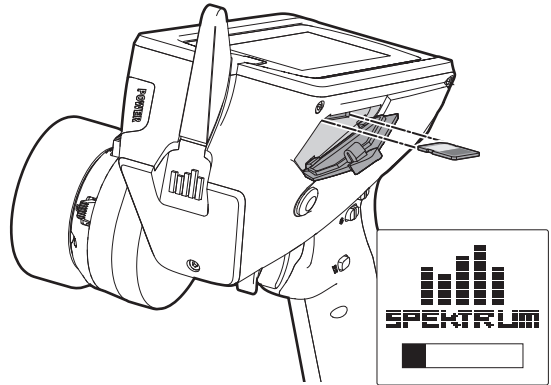

### Registering the Transmitter

Exporting the transmitter serial number to the Micro SD-Card allows you to upload the serial number directly into the registration screen at [www.spektrumrc.com](http://www.spektrumrc.com).

To export the serial number:

1. Install the Micro SD-Card in the card reader slot located behind a small rubber door on the back of the transmitter
2. Click the scroll wheel to enter the FUNCTION LIST.
3. Scroll down to the System Settings menu. Click the scroll wheel once to open the menu.
4. Scroll to ABOUT and click the scroll wheel once to open the menu.
5. When the Serial Number screen appears, select EXPORT.
6. Power off the transmitter and remove the Micro SD-Card from the transmitter.

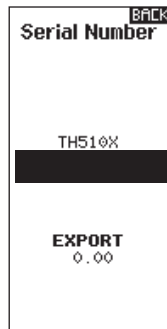

To Upload the serial number to [www.spektrumrc.com](http://www.spektrumrc.com):

1. Insert the Micro SD-Card in your computer and check the contents of the SD card on your computer for a "My\_DX5R.xml" file.
2. In your favorite browser navigate to [www.spektrumrc.com](http://www.spektrumrc.com) and find the Product Registration link on the top of the page as shown.
3. If you do not already have an account, create one now. If you have an account, login in with your secure login.

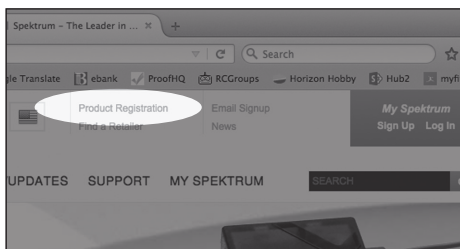

4. Once logged in, go to the "My Spektrum" page. Fill out all relevant information. Once you select your transmitter model from the pull down menu you will be asked to upload the serial number.
5. Click on the Select button to navigate to the "My\_DX5R.xml" file on the Micro SD-Card that is in your computer's SD card reader and select the file.
6. Click on the Upload from xml file... button and the serial number will populate into the Serial Number fields.
7. Click Register at the bottom of the screen to finish registering your new Spektrum Transmitter.

Alternatively, you can copy the serial number from the .xml file and paste directly into the Serial Number field.

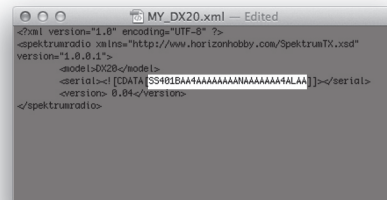

Screen shots from [www.spektrumrc.com](http://www.spektrumrc.com) are correct at time of printing but may change at a future date.

## SD CARD

### Update RaceWare™ Software

**NOTICE:** The orange LED Spektrum bars flash and a status bar appears on the screen when RaceWare™ software updates are installing. Never power off the transmitter when updates are installing. Doing so may damage the system files.

**NOTICE:** Before installing any RaceWare files, always Export All Models to an SD Card separate from the SD Card containing the update. The update may erase all model files.

For more information on RaceWare software updates, visit [www.spektrumrc.com](http://www.spektrumrc.com)

#### Automatically Installing RaceWare Software Updates

1. In your favorite browser, navigate to [www.spektrumrc.com](http://www.spektrumrc.com) and find the Firmware Updates link inside the Setups/Updates tab on the top of the page as shown.

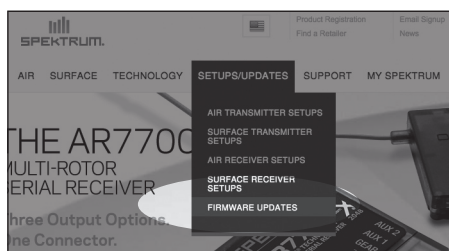

2. Find your registered transmitter in the MY PRODUCTS list and click on Download Updates. Follow directions on the screen for downloading the update to your computer and SD card.

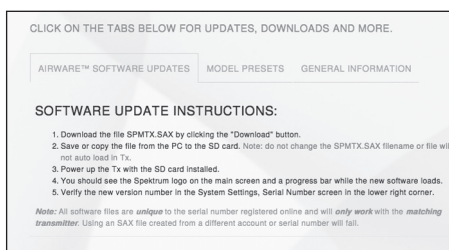
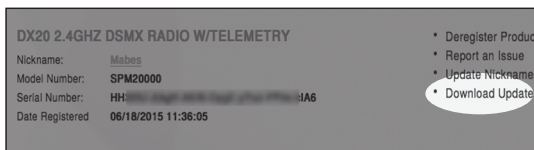

3. Eject the Micro SD Card from the computer.
4. Make sure the transmitter is powered off and install the SD card into the transmitter.
5. Power on the transmitter and the update automatically installs in the transmitter.

#### Manually Installing RaceWare Software Updates

1. Save the desired RaceWare version to the SD Card.
2. Install the SD card into the transmitter.
3. Select Update Firmware in the SD Card Menu options. The Select File screen appears.
4. Select the desired RaceWare version from the File List. When updates are installing, the transmitter screen is dark. The orange LED Spektrum bars flash and the update status bar appears on the screen.

**NOTICE:** Do not power off the transmitter when updates are installing. Doing so will damage the transmitter.

Screen shots from [www.spektrumrc.com](http://www.spektrumrc.com) are correct at time of printing but may change at a future date.

## MAIN SCREEN

The Main Screen displays information about the active model, including the Timer (when activated). To return to the Main Screen at any time, press and hold the scroll wheel for at least 6 seconds.

- A: Transmitter Battery Voltage
- B: User Name
- C: Model Name
- D: Steering Rate
- E: Timer 1 (when activated)
- F: Timer 2 (when activated)
- G: Position of Steering (STR) trim
- H: Position of Throttle (THR) trim
- I: Position of Brake (BRK) trim
- J: Position of Aux 1 trim
- K: Position of Aux 2 trim
- L: Position of Aux 3 trim

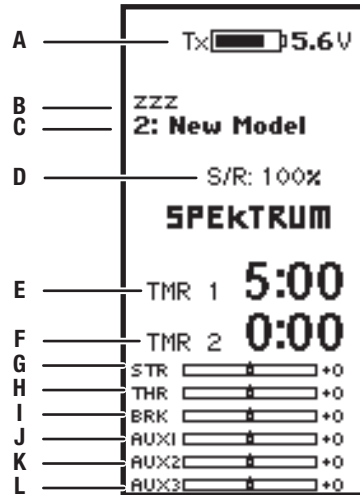

## NAVIGATION

### USING THE SCROLL WHEEL SELECTOR

- Scroll the scroll wheel to move through the screen content or change programming values. Click the scroll wheel to make a selection.
- Use the L Button to go back to go to the previous screen (for example, to go from the Mixing Screen to the Function List).
- Use the R Button to return a selected value on a screen to the default setting.
- The Main Screen appears when you power on the transmitter. Click the scroll wheel once to display the Function List.

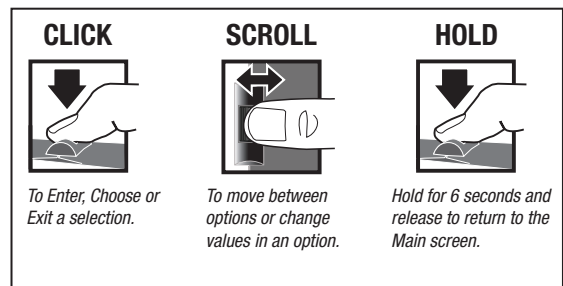

### INDIVIDUAL DIRECTION ADJUSTMENTS

In some instances, you may find it necessary to independently adjust the control directions; for example, if you want more travel for left steering than right steering, perform the following steps:

1. Scroll to the value you wish to change and click the scroll wheel.
2. When both directions are selected, move the control (steering or throttle) toward the control direction you wish to change. The selection box moves to the desired direction. You do not need to hold the control in the desired direction.
3. To change the opposite direction, simply move the control in that direction.
4. Click the scroll wheel to save the selection.

### AUTO SWITCH SELECT

To easily select a switch in a function, such as a program mix, roll with the scroll wheel to highlight the switch selection box, and click the scroll wheel. The box around the switch should now flash. To select a switch, toggle the switch you wish to select. Verify the switch selection is now displayed as desired. When correct, click the scroll wheel to select this switch and complete the switch selection.

**Tip:** The tick mark below shows the current switch position.

Rolling and clicking the scroll wheel turns the selected box black, indicating that the value or condition will act on that position.

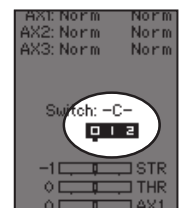

## FUNCTION LIST

Click the scroll wheel from the main screen to access the FUNCTION LIST. The FUNCTION LIST contains all the available menus on the DX5R. The functions include:

- Model Select
- Model Name
- Servo Setup
- Rates
- Exponential
- Timer
- Bind/ Frame Rate
- Mixing
- AVC
- ABS
- Idle Up
- Traction
- Trim Setup
- Channel Assign
- Telemetry
- Drive Mode Name
- System Settings
- System Setup

### MODEL SELECT

Model Select enables you to access any of the 250 internal model memory locations in the Model Select list.

1. Scroll to the desired model memory in the Model Select list.
2. When the desired model memory is highlighted, click the scroll wheel once to select the model. The transmitter returns to the Main Screen.
3. Add a new model by rolling to the bottom of the list. You will then be prompted with the Create New Model screen, with the option to create a new model or cancel. If you select Cancel, the system will return to the Model Select function. If you select Create, the new model will be created and now be available in the model select list.



**CAUTION:** NEVER change the model in Model Select while operating a model. Changing the model memory interrupts the transmitter signal to the receiver and may cause loss of vehicle control, damage or personal injury.



### MODEL NAME

Model Name enables you to assign a custom name to the current model memory. Model names can include up to 15 characters, including spaces.

#### To add letters to a Model Name:

1. Scroll to the desired letter position and click the scroll wheel once. A flashing box appears.
2. Scroll Up or Down until the desired character appears. Click the scroll wheel once to save the character.
3. Scroll to the next desired letter position. Repeat Steps 1 and 2 until the Model Name is complete.
4. Select L button to return to the FUNCTION LIST.

#### To erase a character(s):

1. Press the R button while the character is selected.
2. Press the R button a second time to erase all characters to the right of the cursor.

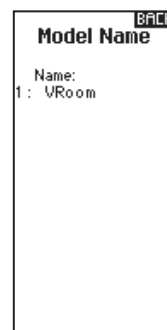



## FUNCTION LIST

### SERVO SETUP

The Servo Setup menu contains the following functions:

Travel		
STR	100L	100R
THR	100L	100H
AX1	100%	100%
AX2	100%	100%
AX3	100%	100%

Sub Trim	
STR	+0
THR	+0
AX1	+0
AX2	+0
AX3	+0

Reverse	
STR	Normal
THR	Normal
AX1	Normal
AX2	Normal
AX3	Normal

Speed	
STR:	100%L 100%R
THR:	100%L 100%H
AX1:	100%- 100%+
AX2:	100%- 100%+
AX3:	100%- 100%+
Switch: On	

#### Travel Adjust

Travel Adjust sets the overall travel or endpoints of the servo arm movement. Travel values range from 0–150% (Default is 100%).

##### To adjust Travel values:

1. Scroll to the channel you wish to adjust and click the scroll wheel.
2. Scroll Up or Down to adjust the travel value. Click the scroll wheel to save the selection.

#### Sub-Trim

Subtrim offsets the entire stroke including the center and endpoint positions.



**CAUTION** Use only small sub-trim values or you may cause damage to the servo.

#### Reverse

Use the Reverse menu to reverse the channel direction. For example, if the Steering servo moves Left and it should move Right.

##### To reverse a channel direction:

1. Scroll to Travel and click the scroll wheel. Scroll up or down until Reverse appears and click the scroll wheel again to save the selection.
2. Scroll to the channel you wish to reverse and click the scroll wheel.

If you reverse the Throttle channel, a confirmation screen appears. Select YES to reverse the channel. A second screen appears, reminding you to bind your transmitter and receiver.



**CAUTION:** Always rebind the transmitter and receiver after reversing the Throttle channel. Failure to do so will result in the throttle moving to full throttle if failsafe activates.

Always perform a control test after making adjustments to confirm the vehicle responds properly.



**CAUTION:** After adjusting servos, always rebind the transmitter and receiver to set the failsafe position.

#### Speed

The Speed menu enables you to slow the response time on any individual channel.

The Speed is adjustable from 100% to 1%.

##### To adjust the Speed:

1. Scroll to the channel you wish to adjust and click the scroll wheel.
2. Scroll Up or Down to adjust the speed and click the scroll wheel to save the selection.
3. Select a switch to activate/deactivate the function. If Switch ON is selected, the value will always be on for that function.

## FUNCTION LIST

### RATES

Rates (dual rate) allow you to make on-the-fly travel adjustments to Steering, Throttle or Brakes using any of the Programmable trimmers. The Rate screen also offers an override function, which allows you to access a second rate (normally 100%) at the touch of a button or trimmer. This is especially helpful for oval racers that program minimal steering throw to desensitize steering during racing, but requires maximum steering angle to drive out of a crash or get turned around on the track.

#### To adjust Rate values:

1. Scroll to Steering and click the scroll wheel to select between Steering, Throttle or Brake. Click the wheel to save the selection.
2. Scroll Up or Down to adjust the Rate value. Click the scroll wheel to save the selection.
3. Select a Rate switch.
4. Select an Override rate and switch.
5. Select the OTF trimmer that will be used to adjust Rates on the fly.

**IMPORTANT:** In order for the OVERRIDE to operate, you must assign it to a switch or trimmer. The default position for this function is inhibited.

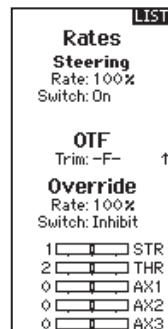

### EXPONENTIAL

The Exponential (Expo) function affects the response rate of the steering, throttle and/or brake. A positive Steering Expo value, for example, decreases steering sensitivity around neutral to make it easier to drive at high speeds in a straight line while still allowing for maximum turning radius. While sensitivity with positive Expo is decreased around neutral, it increases the sensitivity near the end of travel.

#### To adjust Expo values:

1. Select Throttle or Steering.
2. Scroll Up or Down to adjust the Rate value. The graph shows the Expo Curve.
3. Click the scroll wheel to save the selection.
4. Select an OTF switch to activate Exponential.

If Switch ON is selected, the Expo value will always be on for that function. If another switch is selected, the Expo can be turned ON/OFF or 2-3 different Expo values can be entered depending on the switch used.

**IMPORTANT:** Both positive and negative Expo values are available. A positive Expo value results in the center being less sensitive (desirable most of the time), while a negative value increases the sensitivity around center (normally not used).

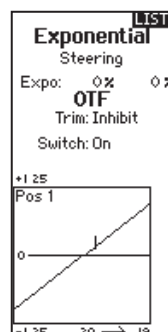

### TIMER

The DX5R Timer function allows you to program a countdown timer and stop watch (count up timer) to display on the main screen. An alarm sounds when the programmed time is reached. You can program the timer to start using the assigned switch position or automatically when throttle moves above a pre programmed position.

Two internal timers are available that show run time for a specific model displayed on the Main Screen, and a total system timer.

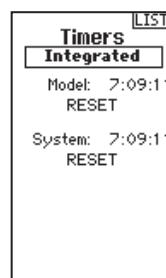
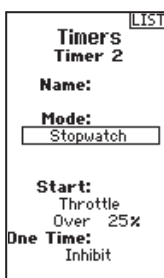
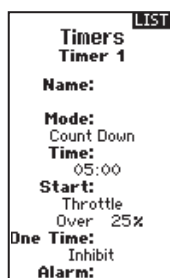

## FUNCTION LIST

### FRAME RATE:

For compatibility with all types of servos, four frame rates are available:

- **5.5ms:** Gives the fastest response rate. Digital Servos and a compatible receiver are required.  
**IMPORTANT:** When 5.5ms frame rate is selected, only two channels (steering and throttle) are operational.
- **11ms:** Offers good response rates and is compatible with most digital and analog servos (this is the default position). Works with DSMR surface receivers.
- **16.5ms:** Needed for older analog servos. Works with DSM2® surface receivers.
- **22ms:** Needed for older analog servos. Works with DSMR® receivers.

**IMPORTANT:** You should always use the fastest response rate the servos can handle. This gives the lowest latency and fastest response. If the frame rate is incompatible with the servo, the servo will move erratically or, in some cases, not at all. If this occurs, change the frame rate to the next highest value.

**IMPORTANT:** Always rebind after changing the Frame Rate.

### BINDING/FRAME RATE

Binding is the Process of teaching the receiver the specific transmitter's code called GUID (Globally Unique Identifier) and storing failsafe values. When a receiver is bound to a transmitter/model memory, the receiver will only respond to that specific transmitter/model memory.

#### BIND THE TRANSMITTER TO THE RECEIVER

1. Place the receiver into Bind mode, the LED on the receiver will begin to flash.
2. Power on the transmitter.
3. Select the Model Memory you wish to bind to.
4. Select Bind from the List menu.
5. Move the throttle channel to the desired failsafe position.

**IMPORTANT:** The throttle channel must stay in the failsafe position until binding is complete.

6. Scroll to Bind and click the scroll wheel. The orange LED flashes on top of the transmitter.
7. When the bind process is complete, the transmitter and receiver LEDs stop flashing and turn solid orange.
8. Remove the bind plug from the receiver and keep it in a convenient place.

**NOTICE:** Always remove the bind plug from the receiver when the bind Process is complete. Failure to do so will cause the receiver to enter bind mode the next time you power on the receiver.

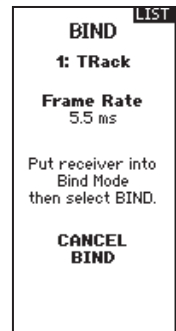

### FAILSAFE

The throttle failsafe position is set during binding. In the unlikely event that the radio link is lost during use, the receiver will drive the throttle servo to its pre-Programmed failsafe position (normally full brakes) and all other channels will have no servo output. If the receiver is turned on prior to turning on the transmitter, the receiver will enter the failsafe mode, driving the throttle servo to its preset failsafe position. When the transmitter is turned on, normal control is resumed.

**IMPORTANT:** Failsafe activates only in the event that signal is lost from the transmitter. Failsafe will NOT activate in the event that receiver battery power decreases below the recommended minimums or power to the receiver is lost.

## FUNCTION LIST

### MIXING

The DX5R features preset steering and throttle mixes and four programmable mixes. If AVC® technology is active, only two channels, Steering and Throttle, are operational. The Aux channels can be used to power a personal transponder, lights, etc.

If AVC technology is disabled (see Disabling the Stability Assist Function to disable AVC), the Aux channels will operate as servo channels. Aux channels are not available for use in mixes when AVC is active.



### STEER MIX

Use the Steer Mix for vehicles requiring either four-wheel steering (4WS) or dual steering servos (Dual ST).

#### 4WS (4-WHEEL STEERING)

1. Select STEERING and click the scroll wheel.
2. Select 4WS and click the scroll wheel.
3. To activate, select Inhibit and scroll to select STR > AUX1.
  - Select AUX1, AUX2 or AUX3 as the Slave\*\* channel.
  - The AUX channels can only be assigned to one mix at a time. If AUX1, AUX2 or AUX3 is assigned to another mix, it will not be available as a slave channel option.
4. Select Trim to Act or Inh (Default). When Trim is Active, adjustments to the steering trim affect both front and rear steering channels.
5. Select Switch to Assign the 4-Wheel Steering Options to a switch to select steering options. Each time you move the switch, the 4-Wheel Steering options appear on the Main Screen.

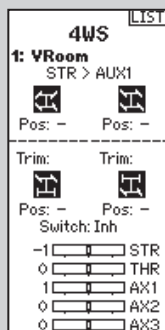
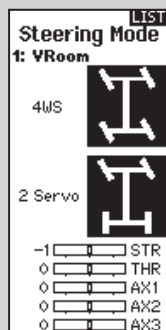

**\*Slave Channel (AUX) Example:** 100% means the slave channel movement is equal to the master channel movement. If you adjust the value to 50%, the slave channel moves half as far as the master channel. A negative value means the mix moves in the opposite direction.

#### 2 SERVO (DUAL STEERING)

1. Select STEERING and click the scroll wheel.
2. Select 2 SERVO and click the scroll wheel.
3. To activate, select Inhibit and scroll to select STR > AUX1.
  - Select AUX1, AUX2 or AUX3 as the Slave\*\* channel.
  - The AUX channels can only be assigned to one mix at a time. If AUX1, AUX2 or AUX3 is assigned to another mix, it will not be available as a slave channel option.

**\*Slave Channel (AUX) Example:** 100% means the slave channel movement is equal to the master channel movement. If you adjust the value to 50%, the slave channel moves half as far as the master channel. A negative value means the mix moves in the opposite direction.

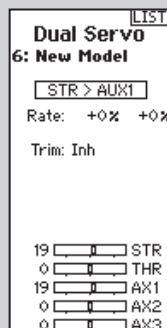

## FUNCTION LIST

### MIXING (CONTINUED)

#### DUAL THROTTLE

Use the DUAL THROTTLE Mix on vehicles that require two throttle channels.

1. Select THROTTLE and click the scroll wheel.
2. Select Dual Throttle and click the scroll wheel.
3. To activate, select Inhibit and scroll to select THR > AUX1\*.
  - \*Select AUX1, AUX2 or AUX3 as the slave channel.
  - The AUX channels can only be assigned to one mix at a time. If AUX1, AUX2 or AUX3 is assigned to another mix, it will not be available as a slave channel option.

To synchronize the servos use the Subtrim, Travel and Reverse menus in Servo Setup.

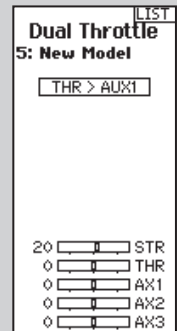

#### DUAL BRAKE

Use the Brake Mix on large scale vehicles that require separate front and rear brake servos. The mix value creates brake bias between the front and rear brakes. Assigning the Brake Mix to a switch enables you to adjust the mix value from any screen.

1. Select THROTTLE and click the scroll wheel.
2. Select Dual Brake and click the scroll wheel.
3. To activate, select Inhibit and scroll to select BRK > AUX1.
  - Select AUX1, AUX2 or AUX3 as the slave channel.
  - The AUX channels can only be assigned to one mix at a time. If AUX1, AUX2 or AUX3 is assigned to another mix, it will not be available as a slave channel option.

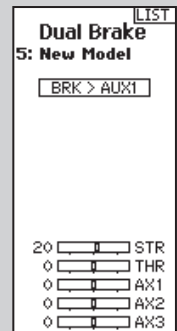

#### MOTOR ON AXLE (MOA)

The MOA Throttle Mix is used to adjust the throttle bias on rock crawlers using a “motor on axle” configuration.

1. Select THROTTLE and click the scroll wheel.
2. Select MOA and click the scroll wheel.
3. To activate, select Inhibit and scroll to select THR > AUX1.
  - Select AUX1, AUX2 or AUX3 as the slave channel.
  - The AUX channels can only be assigned to one mix at a time. If AUX1, AUX2 or AUX3 is assigned to another mix, it will not be available as a slave channel option.
4. Assign a switch to the mix.

Only the rate value for the front motor can be edited. As you configure the front rate, the rear rate is updated appropriately to show the distribution.

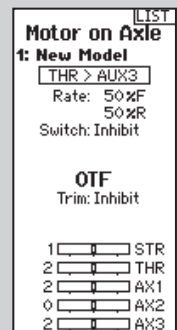

## FUNCTION LIST

### MIXING (CONTINUED)

#### PROGRAMMABLE MIX

The Programmable mixes enable you to assign any channel as a Master or Slave, which is particularly helpful when you need to assign an Aux channel as a Master.

1. Select the desired MIX (Mix 0–3) and click the scroll wheel.
2. Scroll to MASTER and select the Master Channel. Click the scroll wheel.
3. Scroll to SLAVE and select the Slave Channel. Click the scroll wheel.
4. Select Rate to assign Rates for both Master and Slave.
5. Assign a switch to the mix. If Switch ON is selected, the value will always be on for that function.

**NOTICE:** A negative value results in the secondary channel moving in a direction opposite the direction of the primary channel.

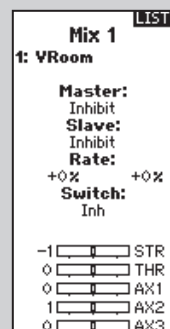

### ACTIVE VEHICLE CONTROL (AVC)

If AVC® technology is active, only three channels, Steering, Throttle and Aux3 are operational. The other Aux channels can be used to power a personal transponder or lights.

If AVC technology is disabled, the Aux channels will operate as servo channels. Aux channels are not available for use in mixes when AVC is active.

#### Options:

- STR Gain
- THR Gain
- Priority

#### To activate AVC:

- Assign a switch to toggle AVC ON/OFF or select ON.

#### STR Gain and/or THR Gain Sensitivity

The default value is 50%. As the value increases, the AVC steering stability and throttle management increases. A value of 0% is off.

1. Adjust the STR Gain until you reach the ideal amount of steering control. If the front wheels begin to shake, the STR Gain value is too high. Reduce the STR Gain value until the front wheels stop shaking. You can assign STR Gain and THR Gain to the Switch, enabling you to adjust both values at the same time.
2. **On The Fly Switch (OTF):** Assigning STR Gain and THR Gain to a switch enables you to adjust the sensitivity without using the AVC menu.

#### Steering Priority

As the steering angle command is increased, the steering gain is decreased. With 100% priority at full steering travel, the steering gain is turned off to allow maximum steering control. This allows full steering stability in a straight line, plus full steering control at full lock with varying degrees of stability proportionally based on the steering angle. Priority is used to adjust the maximum steering rate. If the vehicle spins out, reduce the Priority. If the vehicle won't turn in aggressively as desired, increase the Priority.

#### Deactivating AVC

- Assign switch to INH.

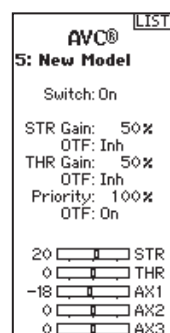

## FUNCTION LIST

### AUTOMATIC BRAKING SYSTEM (ABS)

ABS helps prevent brake lock-ups and improves braking performance by pulsing the brakes.

#### Options:

- **Point:** The throttle position that the pulse braking takes place (0 to 100, default is 50).
- **Stroke:** The distance the throttle travels during the pulse braking (0 to 100, default is 50).
- **Lag:** The time delay before the pulsing takes place (0.0 to 2.0 in .01 increments, default is 0.0).
- **Speed:** The pulsing speed or frequency of the pulse braking (-1 to -30, default is -10).

#### To activate ABS:

1. Assign a switch to toggle ABS ON/OFF or select ON.
2. Select functions to edit.
3. The bar at the bottom of the screen displays the parameters and shows how ABS will function.

#### Deactivating ABS

- Assign switch to INH.

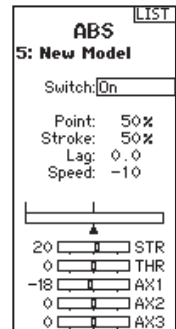

### IDLE UP

Idle up (also called high idle) is used to advance the throttle position on a gas car during startup to prevent the engine from dying before the engine is warmed up.

#### Options:

- **Position:** Adjusts the throttle position when idle up is engaged (0 to 100, default is 0)
- **Warning:** Activates an alarm when the Idle Up is active

#### To activate Idle Up:

1. Assign a switch to toggle Idle Up ON/OFF.
2. Select functions to edit.
3. The bar at the bottom of the screen displays the parameters and shows how Idle Up will function.

#### Deactivating Idle Up

- Assign switch to INH.

**IMPORTANT:** Idle Up must be assigned to a button in order to operate the Idle Up function .

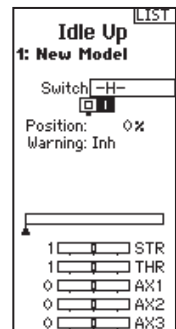

## FUNCTION LIST

### TRACTION

Traction Control helps reduce wheel slippage and improve acceleration by gradually increasing the throttle.

#### Options:

- **Point:** The throttle position that traction control disengages (5 to 100, default is 50).
- **Speed:** The time after pulling the trigger traction control engages (1 to 100, default is 10).

#### To activate Traction:

1. Assign a switch to toggle Traction ON/OFF.
2. Select functions to edit.
3. Select the On The Fly (OTF) switch to edit settings with out going into the Traction menu.
4. The bar at the bottom of the screen displays the parameters and shows how Traction will function.

#### Deactivating Traction:

- Assign switch to INH.

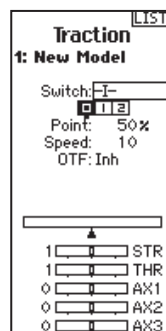

### TRIM SETUP

Trim Setup affects the amount the servo travels with each click of the trim, but has no effect on the total trim travel. The trim steps range from 1 to 20 (Default is 9).

#### To adjust the trim steps:

1. Select channels to edit.
2. Scroll Up or Down to adjust the step value.
3. Click the scroll wheel to save the selection.

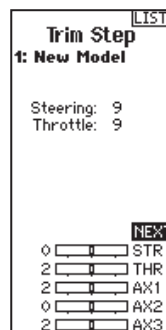

### TRIM ASSIGN

Trim ASSIGN allows for the assigning of a switch to the Steering or Throttle trims.

1. From within Trim Setup, select NEXT.
2. Select channels to assign a switch to.
3. Scroll Up/Down or toggle a switch/button to assign.
4. Click the scroll wheel to save the selection.



### CHANNEL ASSIGN

Channel Assign allows for the assigning of a switch or trimmer as input to an Aux channel.

#### Channel assign:

1. Select a channel to edit. Click the scroll wheel to save the selection.
2. Scroll Up/Down or toggle a switch/button to assign.
3. Click the scroll wheel to save the selection.

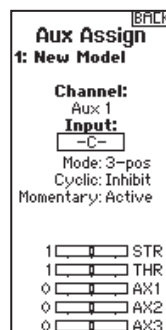



## FUNCTION LIST

### TELEMETRY

The telemetry screen allows for easy access to all telemetry sensors and settings.

#### To add telemetry sensors:

1. Select an empty slot.
2. Push the scroll wheel once and scroll to find the desired telemetry sensor.
3. Click the scroll wheel to save the selection.

#### To edit telemetry sensors:

1. Select the sensor from the list.
2. Push the scroll wheel once to open that sensors settings.
3. Adjust sensor parameters.
4. Click the scroll wheel to save the selection.

**Settings:** Chose how telemetry is displayed on the transmitter.

#### File Settings:

- Displays File name of saved telemetry files.
- Inhibit, activate telemetry file saving.

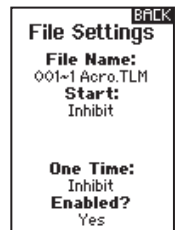
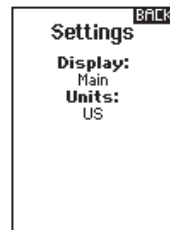
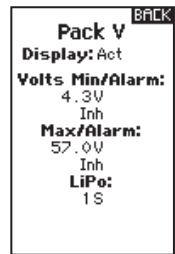
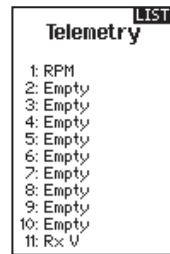

### DRIVE MODE

Every model can have up to 4 drive modes programmed to a switch or button for On-The-Fly adjustments.

Once a drive mode is selected, changes to model setup, trim and timers will only affect that drive mode.

1. Select the On The Fly (OTF) switch to switch between drive modes.
2. Scroll down to Modes; Drive Mode 1 and click the scroll wheel to rename the mode if desired.
3. Select the (+) to add a new Drive Mode.

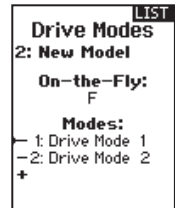

### SYSTEM SETTINGS

System settings allows adjustments to the following transmitter settings:

- **Display**
- **Trims**
- **Sounds**
- **About**
- **Calibrate**

#### DISPLAY

##### User Name

The User Name field displays your name above the model name on the main screen.

1. Scroll to the desired letter position and click the scroll wheel once. A flashing box appears.
2. Scroll Up or Down until the desired character appears. Click the scroll wheel once to save the character.
3. Scroll to the next desired letter position. Repeat Steps 1 and 2 until the Model Name is complete.

##### Contrast

##### To adjust the screen contrast:

1. Scroll to Contrast and click the scroll wheel.
2. Scroll Up or Down to adjust the contrast value. Lower numbers lighten the contrast, higher numbers darken it.
3. Click the scroll wheel once to save the selection.

##### Backlight:

The Backlight field adjusts the backlight appearance time and brightness. You have the option to turn the backlight On or Off or set how long the display stays lit (3, 10, 20, 30, 45 or 60 seconds).

##### Battery:

Select from Alka (default), Lilon, LiPo or NiMH battery types. Note that when the battery type is changed the Battery alarm automatically changes for the correct type of battery chemistry.

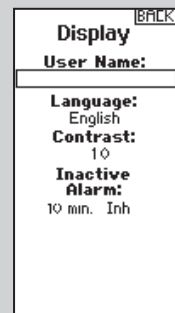
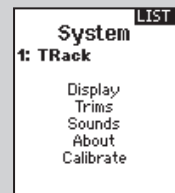

## FUNCTION LIST

### SYSTEM SETTINGS (CONTINUED)

#### Alarm:

Set the low voltage for each battery type. The recommended low voltage threshold is set by default for each battery type.



**CAUTION:** Never select NiMH when a LiPo/Li-Ion battery is installed in the transmitter. Doing so may over-discharge the LiPo battery and damage the battery, transmitter or both.



**CAUTION:** Never adjust the low voltage limit for the LiPo/Li-Ion battery pack below 6.4V. Doing so could over-discharge the battery pack and damage both battery pack and transmitter.

#### Language:

Change the transmitters language.

#### Inactive Alarm:

An alarm activates if the transmitter sees a period of inactivity for a certain amount of time. The alarm is helpful in reminding you to power off the transmitter and avoiding a situation where the transmitter battery completely discharges.

- Inh (No alarm sounds)
- 10 min (Default)
- 5 min
- 30 min
- 60 min

### TRIMS

Assign Trims to any trimmer or switch on the transmitter.

1. Select the Trim position from the list.
2. Push the scroll wheel once to select the position.
3. Scroll to select the Trim desired in that position.
4. Click the scroll wheel to save the selection.

### SOUND SETTINGS

Turn system sounds ON/OFF.

1. Select the sound from the list.
2. Push the scroll wheel once to Activate/Inhibit.
3. Click the scroll wheel to save the selection.

### ABOUT

Displays the transmitter's Serial Number.

### CALIBRATE

Use this menu to calibrate controls. After making any physical transmitter changes it is recommended to calibrate the transmitter.

1. Move the Steering Wheel, Throttle/Brake and the knob from stop to stop.
2. Center the knob.
3. Save when finished or cancel to go back.

**LIST**

**Trim Options**

**1: VRoom**

Pos.	Type
1:	Steering Trim
2:	Throttle Trim
3:	Brake Trim
4:	Aux1 Trim
5:	Aux2 Trim
6:	Aux3 Trim

**BACK**

**Sound Settings**

Roller: Active  
 Timer: Active  
 Trim: Active  
 Keyclick: Active  
 Switch: Active

**Calibrate**

**Steering:**  
 ?? ?? ??  
 7695 7695 7968

**Trigger:**  
 ?? ?? ??  
 7968 7972 7972

**Knob:**  
 ?? ?? ??  
 7747 7751 7751

## SYSTEM SETUP

Press and hold the scroll wheel while powering on the transmitter to show the System Setup list. No radio transmission occurs when a System Setup screen is displayed, preventing accidental damage to linkages and servos during changes to programming.

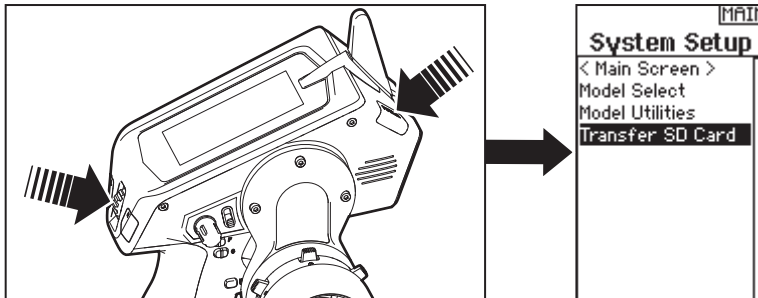

You can also enter the System Setup from the Function list without turning the transmitter off. A Caution screen will appear that warns that RF will be disabled (the transmitter will no longer transmit). Press **YES** if you are sure and want to access the System List. If you are not sure, press **NO** to exit to the main screen and continue operation.

If you do not press **YES** or **NO**, the system will exit to the main screen and continue operation within approximately 10 seconds.



**WARNING:** Do not press **YES** unless the model is turned off and secured.



## MODEL SELECT

Model Select enables you to access any of the 250 internal model memory locations in the Model Select list.

1. Scroll to the desired model memory in the Model Select list.
2. When the desired model memory is highlighted, click the scroll wheel once to select the model. The transmitter returns to the Main Screen.
3. Add a new model by rolling to the bottom of the list. You will then be prompted with the Create New Model screen.



**CAUTION:** NEVER change the model in Model Select while operating a model. Changing the model memory interrupts the transmitter signal to the receiver and may cause loss of vehicle control, damage or personal injury.



## MODEL UTILITIES

In the Model Utilities function you can create a new model, delete a model, copy a model, reset a model to default settings and sort the model list.



## SYSTEM SETUP

### CREATE NEW MODEL

1. Select the CREATE NEW MODEL and click the scroll wheel.
2. Select CREATE to create a new model or CANCEL to go back.
3. The new model is available in the model select list.



**CAUTION:** NEVER change the model in Model Select while operating a model. Changing the model memory interrupts the transmitter signal to the receiver and may cause loss of vehicle control, damage or personal injury.

#### Create New Model

Do you want to create a new model?

CANCEL  
CREATE

### DELETE MODEL

Use this selection to permanently delete a model from the model select list. If you do not wish to delete a model, select Cancel to exit the page.

1. To delete a model, highlight the model listed. Press to select then roll to the model name. Click the scroll wheel to select.
2. Select DELETE to delete the model.

#### Delete Model BACK

Model-1

2: New Model

DELETE THIS MODEL?

CANCEL  
DELETE

### COPY MODEL

The Model Copy menu enables you to duplicate model programming from one Model List location to another.

Use Model Copy to:

- Save a default model copy before experimenting with programming values
- Expedite programming for a model using a similar programming setup

**IMPORTANT:** Copying a model program from one model memory to another will erase any programming in the "To" model memory.

To copy model programming:

1. Select where to save the copied memory by selecting "TO" and scroll to ADD NEW MODEL. Click the scroll wheel once to save the selection. To save over a current model select that model from the list.
2. Select the model to be copied by selecting "From" and scroll to the model to be Copied.
3. Scroll down to COPY at the bottom of the screen and click the scroll wheel once.
4. Confirm the copy by selecting COPY or CANCEL to go back.

You cannot use the Model Copy screen to copy model programming to an SD Card. To copy model programming to the SD Card, please see "Transfer SD Card".

#### Model Copy LIST

From 2

2: New Model

To 250

< Add New Model >

CANCEL  
COPY

### RESET MODEL

Use the Model Reset menu to delete all model programming in the active model memory. Reset returns all model settings to the default settings and erases all programming in the selected model.

**IMPORTANT:** After a model reset, it is necessary to re-bind.

### SORT MODEL LIST

With this function you can sort the model order in the model select function. This is helpful to group similar models together to make them easy to find. To move a model, highlight the model that you wish to move with the scroll wheel, then click the scroll wheel to select it. Scroll the scroll wheel to move the selected model to the position desired. Click the scroll wheel when you have the model in the position desired.

#### Confirm Reset BACK

Model-2

2: New Model

DATA WILL BE RESET

CANCEL  
RESET

## SYSTEM SETUP

### TRANSFER SD CARD

The SD Card enables you to:

- Import model(s) from another DX5R transmitter
- Export model(s) to another DX5R transmitter
- Update firmware in the transmitter

### IMPORT MODEL

To import an individual model file from the SD Card:

1. Save the model file to the SD Card and insert into the transmitter.
2. In the Transfer SD Card menu, scroll to Options and click the scroll wheel once.
3. Scroll to Import Model and press the scroll button again to save the selection. The Select File screen appears.
4. Select the model file you wish to import. The Import Model screen appears.
5. Select Import to save the model to the transmitter. The new model will be appended to the end of the model list.

#### Import All Models

To import all models from the SD Card:

1. Select Import All Models.
2. Confirm by selecting IMPORT.

**IMPORTANT:** After importing a model, you must rebind the transmitter and receiver.



### EXPORT MODEL

You can use the Export Model option to export a single model file to the SD Card.

1. Make sure the active model file is the one you wish to Export.
2. In the Transfer SD Card menu, scroll to Options and click the scroll wheel once.
3. Scroll to Export Model and click the scroll wheel again to save the selection. The Export to SD screen appears. The first two characters of the file name correspond to the Model List number (01, for example).
4. Select Export to save the file to the SD Card. When the export is complete, the transmitter returns to the SD Card Menu screen.

#### Export All Models

To export all models to the SD Card:

1. Select Export All Models in the Transfer SD Card Menu options. The Export All Models screen appears.

**IMPORTANT:** Export All Models will overwrite any model files that have the same name. Always save model files to a different SD card if you are not sure.

2. Select Export to overwrite files on the SD Card or Cancel to return to the SD Card Menu.

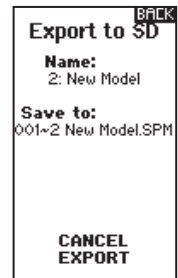

### UPDATE FIRMWARE

Before installing any files, always Export All Models to an SD Card separate from the SD Card containing the update. The update may erase all model files.

#### Automatically Installing Firmware

1. Download the update from spektrumrc.com and save it to the SD Card.
2. Power off the transmitter and install the SD Card in the transmitter.
3. Power on the transmitter and the update automatically installs in the transmitter.

#### Manually Installing AirWare Software Updates

1. Save the desired Firmware to the SD Card.
2. Select Update Firmware in the SD Card Menu options. The Select File screen appears.
3. Select the desired Firmware version from the File List. When updates are installing, the transmitter screen is dark. The orange LED Spektrum bars flash and the update status bar appears on the screen.

**NOTICE:** Do not power off the transmitter when updates are installing. Doing so will damage the transmitter.



## PHYSICAL TRANSMITTER ADJUSTMENTS

The DX5R is designed to be extremely adjustable to suite a wide variety of driver needs. Available adjustments are:

- Adjustable trigger and steering tension
- Multiple trigger position
- Multiple wheel drop-down options
- 2 optional grip sizes (not included)
- 10° and 15° Steering Adapters (not included)
- Small and Large Steering Wheel (small wheel not included)

### Throttle Distance Adjustment

Loosen the bolt with a 2.5mm hex wrench. Move the throttle trigger in or out and tighten.

### Throttle Tension Adjustment

Turn the screw clockwise with the 1.5mm hex wrench to increase the trigger tension.

### Steering Tension Adjustment

Turn the screw clockwise with the 1.5mm hex wrench to increase the steering tension.

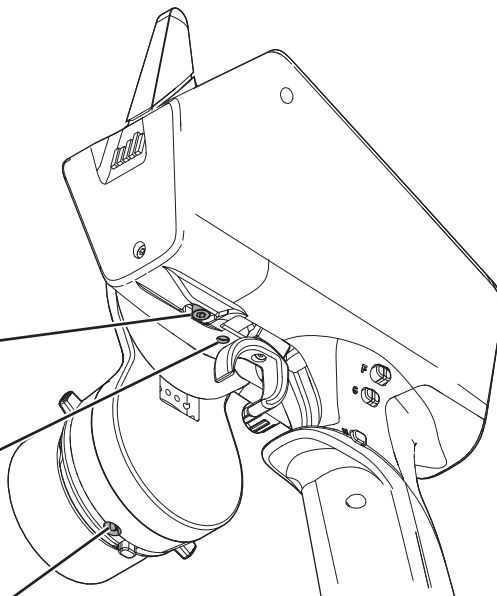

## CHANGING GRIPS

The DX5R comes with the medium-size grip installed at the factory. To install optional (sold separately) size grips:

- Lift the edge of the grip and pull the grip away from the handle.
- Align the tabs on the new grip with the slots in the handle.
- Press the grip against the handle.

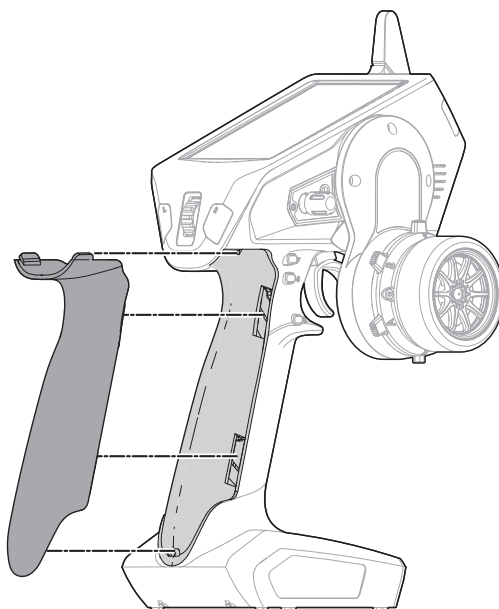

## PHYSICAL TRANSMITTER ADJUSTMENTS

### DROPDOWN STEERING WHEEL OPTIONS

The DX5R comes with the dropdown wheel installed. The dropdown can be rotated for a perfect feel or removed for a standard wheel layout. All the parts necessary to convert to the standard wheel are included.

#### ROTATE:

- Turn off the DX5R
- Using a 2mm hex wrench, remove 3 screws.
- Rotate the drop down to the desired angle.
- Align with the screw holes and re-install the 3 screws being careful not to pinch any wires.

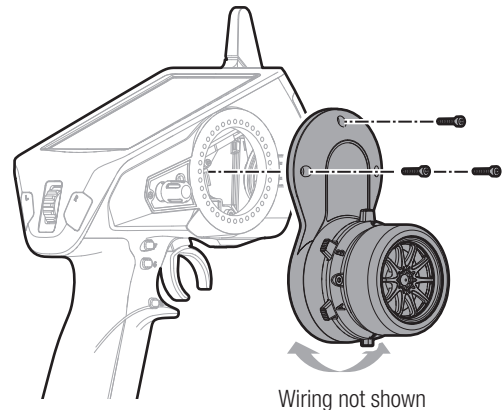

### STANDARD WHEEL CONVERSION:

- Using a 2mm hex wrench, remove the 3 screws from the drop down and remove the drop down from the transmitter. Carefully disconnect the 2 wiring harness from inside the transmitter.
- Using a 1.5mm hex wrench, remove the steering wheel.
- Using a 2mm hex wrench, remove 2 screws from the steering mechanism. Remove the steering mechanism from the drop down being careful to pull the wiring harness through the opening.
- Keep the drop down in a safe place for future use.
- Connect the 2 wiring harnesses to the board inside the DX5R. Note that one connector has 6 pins and the other has 7.
- Re-install the steering mechanism directly onto the transmitter using the 2 screws.
- Re-install the steering wheel.

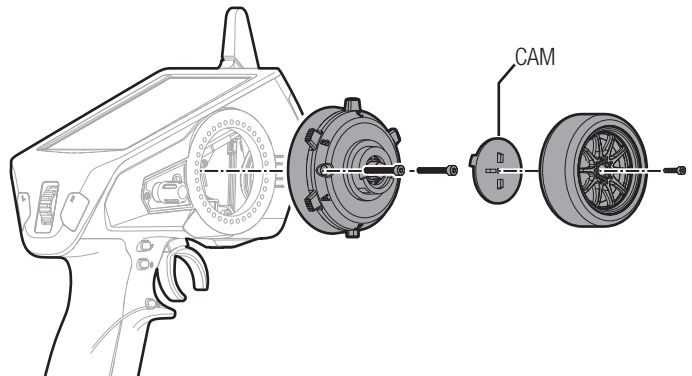

### STEERING WHEEL WEDGES (NOT INCLUDED)

- Refer to the Dropdown steering wheel options section above for directions on removing and installing the steering mechanism.
- The wedge goes between the steering mechanism and the drop down (or transmitter if the drop down is not being used) and can be rotated to almost any angle.

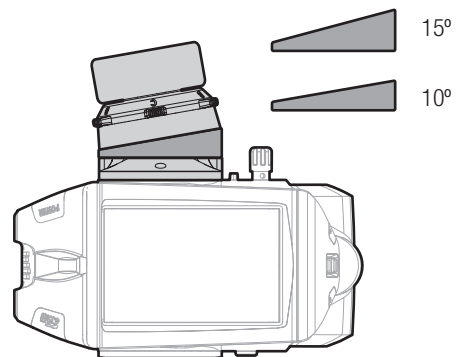

## RECEIVER COMPATIBILITY

The DX5R transmitter is compatible with Spektrum™ DSMR® receivers. The included Spektrum SR6000T\* Telemetry Surface receiver is compatible with all Spektrum DSMR transmitters and is also backwards compatible with DSM2 transmitters.

\*For more information on the SR6000T receiver, see the receivers full manual.

- A: Voltage sensor port
- B: Temperature sensor port
- C: Bind Button
- D: Antenna
- E: RPM sensor port
- F: XBUS Port
- G: Servo ports-
  - Bind/Battery
  - Steering
  - Throttle
  - Aux1-Aux4

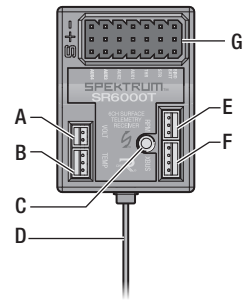

## Receiver Installation and Setup

Install the Receiver in your vehicle using double-sided foam servo tape. Foam servo tape will hold the receiver in place and help isolate it from vibrations.

Mount the antenna up and away from the vehicle. The higher up the antenna is, the better signal it will receive.

**NOTICE:** Do not cut or modify the antenna.

### Powering the receiver with a separate receiver pack

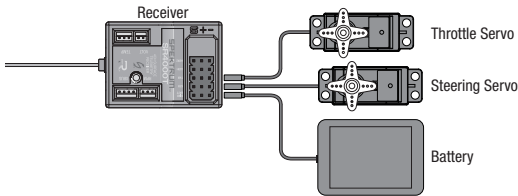

### Powering the receiver with an ESC

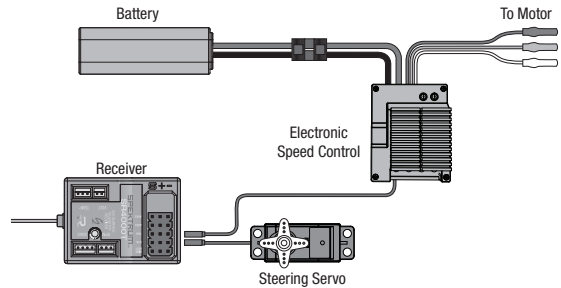

## Binding

1. Push and hold the bind button on the receiver while powering up the receiver. The orange LED will flash continuously, indicating that the receiver is in bind mode.

**Tip:** It is possible to use a bind plug in the BIND/BATT port if desired.

2. With all channels in the desired preset failsafe position (normally neutral), put your transmitter in bind mode. Continue holding the failsafe position until the binding process is complete.

3. The bind process is complete when the orange LED on the receiver is solid.

**CAUTION:** When the bind process is complete, the throttle and steering channels are active. Keep hands and loose objects away from all spinning parts on the vehicle.

## OPTIONAL PARTS LIST

PART #	PARTS DESCRIPTION
SPM6719	Spektrum DX6R Transmitter Case
SPM9050	Grip Set, S, M, L: DX6R
SPM9052	Small Wheel w/Foam: DX6R
SPM9053	Wedges, 10/15 Deg: DX6R
SPM9055	Wheel Cam Set, 32/36 Deg: DX6R
SPM9058	Grip Attachment Tape: DX6R



## TROUBLESHOOTING GUIDE

PROBLEM	POSSIBLE CAUSE	SOLUTION
The system will not connect	Transmitter and receiver too near each other	Move transmitter 8 to 12 feet (2.4 to 3.6m) from receiver
	Transmitter and receiver too near large metal objects (vehicles, etc.)	Move away from large metal objects (vehicles, etc.)
	Selected model is not bound in transmitter	Make sure correct model memory is selected and that transmitter is bound to the model
	Transmitter accidentally put in bind mode so receiver is no longer bound	Rebind transmitter and receiver
The receiver goes into failsafe mode a short distance away from the transmitter	Check the receiver antenna to be sure it is not cut or damaged	Replace or contact Horizon product Support
		Make sure receiver antenna is in an antenna tube and is above vehicle
Receiver quits responding during operation	Low battery voltage	Completely recharge battery
	Loose or damaged wires or connectors between battery and receiver	Do a check of the wires and connection between battery and receiver. Repair or replace wires and/or connectors
Receiver loses its bind	Transmitter accidentally put in bind mode, ending bind to receiver	Bind transmitter to receiver
Receiver taking longer than usual to link with transmitter	Transmitter and receiver are operating on Marine model	Marine receivers can take longer to link with transmitter

## 1-YEAR LIMITED WARRANTY

### What this Warranty Covers

Horizon Hobby, LLC, (Horizon) warrants to the original purchaser that the product purchased (the "Product") will be free from defects in materials and workmanship for a period of 1 year from the date of purchase.

### What is Not Covered

This warranty is not transferable and does not cover (i) cosmetic damage, (ii) damage due to acts of God, accident, misuse, abuse, negligence, commercial use, or due to improper use, installation, operation or maintenance, (iii) modification of or to any part of the Product, (iv) attempted service by anyone other than a Horizon Hobby authorized service center, (v) Product not purchased from an authorized Horizon dealer, (vi) Product not compliant with applicable technical regulations or (vii) use that violates any applicable laws, rules, or regulations.

OTHER THAN THE EXPRESS WARRANTY ABOVE, HORIZON MAKES NO OTHER WARRANTY OR REPRESENTATION, AND HEREBY DISCLAIMS ANY AND ALL IMPLIED WARRANTIES, INCLUDING, WITHOUT LIMITATION, THE IMPLIED WARRANTIES OF NON-INFRINGEMENT, MERCHANTABILITY AND FITNESS FOR A PARTICULAR PURPOSE. THE PURCHASER ACKNOWLEDGES THAT THEY ALONE HAVE DETERMINED THAT THE PRODUCT WILL SUITABLY MEET THE REQUIREMENTS OF THE PURCHASER'S INTENDED USE.

### Purchaser's Remedy

Horizon's sole obligation and purchaser's sole and exclusive remedy shall be that Horizon will, at its option, either (i) service, or (ii) replace, any Product determined by Horizon to be defective. Horizon reserves the right to inspect any and all Product(s) involved in a warranty claim. Service or replacement decisions are at the sole discretion of Horizon. Proof of purchase is required for all warranty

claims. SERVICE OR REPLACEMENT AS PROVIDED UNDER THIS WARRANTY IS THE PURCHASER'S SOLE AND EXCLUSIVE REMEDY.

### Limitation of Liability

HORIZON SHALL NOT BE LIABLE FOR SPECIAL, INDIRECT, INCIDENTAL OR CONSEQUENTIAL DAMAGES, LOSS OF PROFITS OR PRODUCTION OR COMMERCIAL LOSS IN ANY WAY, REGARDLESS OF WHETHER SUCH CLAIM IS BASED IN CONTRACT, WARRANTY, TORT, NEGLIGENCE, STRICT LIABILITY OR ANY OTHER THEORY OF LIABILITY, EVEN IF HORIZON HAS BEEN ADVISED OF THE POSSIBILITY OF SUCH DAMAGES. Further, in no event shall the liability of Horizon exceed the individual price of the Product on which liability is asserted. As Horizon has no control over use, setup, final assembly, modification or misuse, no liability shall be assumed nor accepted for any resulting damage or injury. By the act of use, setup or assembly, the user accepts all resulting liability. If you as the purchaser or user are not prepared to accept the liability associated with the use of the Product, purchaser is advised to return the Product immediately in new and unused condition to the place of purchase.

### Law

These terms are governed by Illinois law (without regard to conflict of law principals). This warranty gives you specific legal rights, and you may also have other rights which vary from state to state. Horizon reserves the right to change or modify this warranty at any time without notice.

### WARRANTY SERVICES

#### Questions, Assistance, and Services

Your local hobby store and/or place of purchase cannot provide warranty support or service. Once assembly, setup or use of the Product has been started, you must contact your local distributor or Horizon directly. This will enable Horizon to better answer your

questions and service you in the event that you may need any assistance. For questions or assistance, please visit our website at [www.horizonhobby.com](http://www.horizonhobby.com), submit a Product Support Inquiry, or call the toll free telephone number referenced in the Warranty and Service Contact Information section to speak with a Product Support representative.

### Inspection or Services

If this Product needs to be inspected or serviced and is compliant in the country you live and use the Product in, please use the Horizon Online Service Request submission process found on our website or call Horizon to obtain a Return Merchandise Authorization (RMA) number. Pack the Product securely using a shipping carton. Please note that original boxes may be included, but are not designed to withstand the rigors of shipping without additional protection. Ship via a carrier that provides tracking and insurance for lost or damaged parcels, as Horizon is not responsible for merchandise until it arrives and is accepted at our facility. An Online Service Request is available at [http://www.horizonhobby.com/content/service-center\\_render-service-center](http://www.horizonhobby.com/content/service-center_render-service-center). If you do not have internet access, please contact Horizon Product Support to obtain a RMA number along with instructions for submitting your product for service. When calling Horizon, you will be asked to provide your complete name, street address, email address and phone number where you can be reached during business hours. When sending product into Horizon, please include your RMA number, a list of the included items, and a brief summary of the problem. A copy of your original sales receipt must be included for warranty consideration. Be sure your name, address, and RMA number are clearly written on the outside of the shipping carton.

**NOTICE: Do not ship LiPo batteries to Horizon. If you have any issue with a LiPo battery, please contact the appropriate Horizon Product Support office.**

### Warranty Requirements

For Warranty consideration, you must include your original sales receipt verifying the proof-of-purchase date. Provided warranty conditions have been met, your Product will be serviced or replaced free of charge. Service or replacement decisions are at the sole discretion of Horizon.

### Non-Warranty Service

**Should your service not be covered by warranty, service will be completed and payment will be required without notification or estimate of the expense unless the expense exceeds 50% of the retail purchase cost.** By submitting the item for service you are agreeing to payment of the service without notification. Service estimates are available upon request. You must include this request with your item submitted for service. Non-warranty service estimates will be billed a minimum of ½ hour of labor. In addition you will be billed for return freight. Horizon accepts money orders and cashier's checks, as well as Visa, MasterCard, American Express, and Discover cards. By submitting any item to Horizon for service, you are agreeing to Horizon's Terms and Conditions found on our website [http://www.horizonhobby.com/content/service-center\\_render-service-center](http://www.horizonhobby.com/content/service-center_render-service-center).

**ATTENTION: Horizon service is limited to Product compliant in the country of use and ownership. If received, a non-compliant Product will not be serviced. Further, the sender will be responsible for arranging return shipment of the un-serviced Product, through a carrier of the sender's choice and at the sender's expense. Horizon will hold non-compliant Product for a period of 60 days from notification, after which it will be discarded.**

10-15

## WARRANTY AND SERVICE CONTACT INFORMATION

Country of Purchase	Horizon Hobby	Contact Information	Address
United States of America	Horizon Service Center (Repairs and Repair Requests)	<a href="http://servicecenter.horizonhobby.com/RequestForm/">servicecenter.horizonhobby.com/ RequestForm/</a>	4105 Fieldstone Rd Champaign, Illinois, 61822 USA
	Horizon Product Support (Product Technical Assistance)	<a href="mailto:productsupport@horizonhobby.com">productsupport@horizonhobby.com</a> 877-504-0233	
	Sales	<a href="mailto:websales@horizonhobby.com">websales@horizonhobby.com</a> 800-338-4639	
EU	Horizon Technischer Service	<a href="mailto:service@horizonhobby.eu">service@horizonhobby.eu</a>	Hanskampring 9 D 22885 Barsbüttel, Germany
	Sales: Horizon Hobby GmbH	+49 (0) 4121 2655 100	

## FCC INFORMATION

### FCC ID: BRWDAMTX12

This equipment has been tested and found to comply with the limits for Part 15 of the FCC rules. These limits are designed to provide reasonable protection against harmful interference in a residential installation. This equipment generates, uses and can radiate radio frequency energy and, if not installed and used in accordance with the instructions, may cause harmful interference to radio communications.

However, there is no guarantee that interference will not occur in a particular installation. If this equipment does cause harmful interference to radio or television reception, which can be determined by turning the equipment off and on, the user is encouraged to try to correct the interference by one or more of the following measures:

- Reorient or relocate the receiving antenna.
- Increase the separation between the equipment and receiver.
- Connect the equipment to an outlet on a circuit different from that to which the receiver is connected.

This device complies with part 15 of the FCC rules. Operation is subject to the following two conditions: (1) This device may not cause harmful interference, and (2) this device must accept any interference received, including interference that may cause undesired operation.

**Note:** Modifications to this product will void the user's authority to operate this equipment.

### RF Radiation Exposure Statement

1. This Transmitter must not be co-located or operating in conjunction with any other antenna or transmitter.
2. This equipment complies with FCC RF radiation exposure limits set forth for an uncontrolled environment. This equipment should be installed and operated with a minimum distance of 20 centimeters between the radiator and your body.

### Antenna Separation Distance

When operating your Spektrum transmitter, please be sure to maintain a separation distance of at least 20 cm between your body (excluding fingers, hands, wrists, ankles and feet) and the antenna to meet RF exposure safety requirements as determined by FCC regulations.

The illustrations show the approximate 20 cm RF exposure area and typical hand placement when operating your Spektrum transmitter.

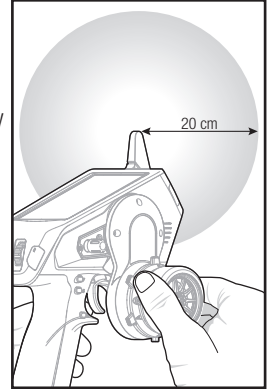

## IC INFORMATION

### IC: 6157A-AMTX12

This device complies with Industry Canada license-exempt RSS standard(s). Operation is subject to the following two conditions: (1) this device may not cause interference, and (2) this device must accept any interference, including interference that may cause undesired operation of the device.

## COMPLIANCE INFORMATION FOR THE EUROPEAN UNION



Horizon Hobby, LLC hereby declares that this product is in compliance with the essential requirements and other relevant provisions of the RED Directive.

A copy of the EU Declaration of Conformity is available online at:  
<http://www.horizonhobby.com/content/support-render-compliance>.



### Instructions for disposal of WEEE by users in the European Union

This product must not be disposed of with other waste. Instead, it is the user's responsibility to dispose of their waste equipment by handing it over to a designated collection point for the recycling of waste electrical and electronic equipment. The separate collection and recycling of your waste equipment at the time of disposal will help to conserve natural resources and ensure that it is recycled in a manner that protects human health and the environment. For more information about where you can drop off your waste equipment for recycling, please contact your local city office, your household waste disposal service or where you purchased the product.



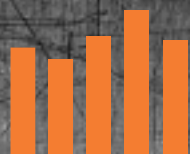

# SPEKTRUM®

Innovative Spread Spectrum Technology

48104.2

© 2018 Horizon Hobby, LLC.

DSM, DSM2, DSMR, AVC, Active Vehicle Control and RaceWare are trademarks or registered trademarks of Horizon Hobby, LLC.

The Spektrum trademark is used with permission of Bachmann Industries, Inc.

All other trademarks, service marks and logos are property of their respective owners.

US 9,320,977. Other patents pending.

01/18