



DX4S

4-Channel 2.4GHz DSMR™ System



Instruction Manual
Bedienungsanleitung
Manuel d'utilisation
Manuale di istruzioni

NOTICE

All instructions, warranties and other collateral documents are subject to change at the sole discretion of Horizon Hobby, LLC. For up-to-date product literature, visit horizonhobby.com and click on the support tab for this product.

MEANING OF SPECIAL LANGUAGE

The following terms are used throughout the product literature to indicate various levels of potential harm when operating this product:

NOTICE: Procedures, which if not properly followed, create a possibility of physical property damage AND little or no possibility of injury.

CAUTION: Procedures, which if not properly followed, create the probability of physical property damage AND a possibility of serious injury.

WARNING: Procedures, which if not properly followed, create the probability of property damage, collateral damage and serious injury OR create a high probability of superficial injury.



WARNING: Read the ENTIRE instruction manual to become familiar with the features of the product before operating. Failure to operate the product correctly can result in damage to the product, personal property and cause serious injury.

This is a sophisticated hobby product. It must be operated with caution and common sense and requires some basic mechanical ability. Failure to operate this Product in a safe and responsible manner could result in injury or damage to the product or other property. This product is not intended for use by children without direct adult supervision. Do not attempt disassembly, use with incompatible components or augment product in any way without the approval of Horizon Hobby, LLC. This manual contains instructions for safety, operation and maintenance. It is essential to read and follow all the instructions and warnings in the manual, prior to assembly, setup or use, in order to operate correctly and avoid damage or serious injury.

**WARNING AGAINST COUNTERFEIT PRODUCTS**

Always purchase from a Horizon Hobby, LLC authorized dealer to ensure authentic high-quality Spektrum product. Horizon Hobby, LLC disclaims all support and warranty with regards, but not limited to, compatibility and performance of counterfeit products or products claiming compatibility with DSM or Spektrum.

NOTICE: This product is only intended for use with unmanned, hobby-grade, remote-controlled vehicles and aircraft. Horizon Hobby disclaims all liability outside of the intended purpose and will not provide warranty service related thereto.

Age Recommendation: Not for Children under 14 years. This is not a toy.

WARRANTY REGISTRATION

Visit community.spektrumrc.com today to register your product.

SAFETY PRECAUTIONS

- Always ensure all batteries have been properly charged prior to using the model.
- Always check all servos and their connections prior to each run.
- Never operate your model near spectators, parking areas or any other area that could result in injury to people or damage of property.
- Never operate your model during adverse weather conditions. Poor visibility can cause disorientation and loss of control of your model.
- Never point the transmitter antenna directly toward the model. The radiation pattern from the tip of the antenna is inherently low.
- If at any time during the operation of your model you observe any erratic or abnormal operation, immediately stop operation of your model until the cause of the problem has been ascertained and corrected.

Building on the success of the DX3S transmitter, the Spektrum™ DX4S transmitter with DSMR™ protocol brings you even more features, including pre-programmed steering mixes, full switch assignability and a convenient back-lit display. Spektrum DSMR technology is an exclusive, frequency-agile 2.4GHz protocol that provides surface RC vehicles and boats with superb range and response. This is particularly true in environments where many other 2.4GHz transmitters are in use at the same time. Spektrum DSMR transmitters are also backwards compatible with DSM2® technology.

TABLE OF CONTENTS

Warranty Registration	2	Bind Transmitter to Receiver	10
Identifying Controls and Switches	4	Sub-Trim.....	11
Installing Batteries	4	Timer	12
Installing Optional Li-Po Battery Pack.....	5	Switch	12
Changing the Rubber Grip.....	5	Mixing.....	13
Updating the Firmware	5	Motor On Axle (MOA) Throttle Mix.....	14
ModelMatch.....	5	Active Vehicle Control (AVC).....	15
Warning Screens	6	Servo Speed	16
Low Battery Alarm	6	ABS (Automatic Breaking System or pulse brakes) 16	
Inactivity Alarm	6	Trim Step	16
Main Screen	6	Throttle Punch	17
Programming Guide.....	6	Reset	17
Individual Direction Adjustments	7	Monitor	17
List	7	System	18
Model Select.....	7	Troubleshooting Guide	20
Copy	7	FCC Information.....	21
Reverse	8	Antenna Separation Distance.....	21
Travel.....	8	Warranty and Repair Policy	21
Exponential	8	Warranty and Service Contact Information	21
Receiver Compatibility	9	Declaration of Conformity	22
Electric Vehicle Installation	10	European Union Information.....	22
Typical Nitro Vehicle Installation	10		
Failsafe	10		

IDENTIFYING CONTROLS AND SWITCHES

Function	Function
(A) Switch A	(I) Rubber Grip
(B) Switch B	(J) Power Switch
(C) Switch C	(K) Power LED
(D) Switch D	(L) Battery Cover
(E) Switch E	(M) Throttle Trigger
(F) Switch F	(N) Steering Wheel
(G) Roller Selector	(O) Antenna
(H) Memory Card Port (under rubber grip)	(P) LCD Screen

Press the power switch (J) to power ON the transmitter. The Power LED (K) will come on, a Spektrum logo screen will show, then the Main Screen will show on the LCD screen (P).

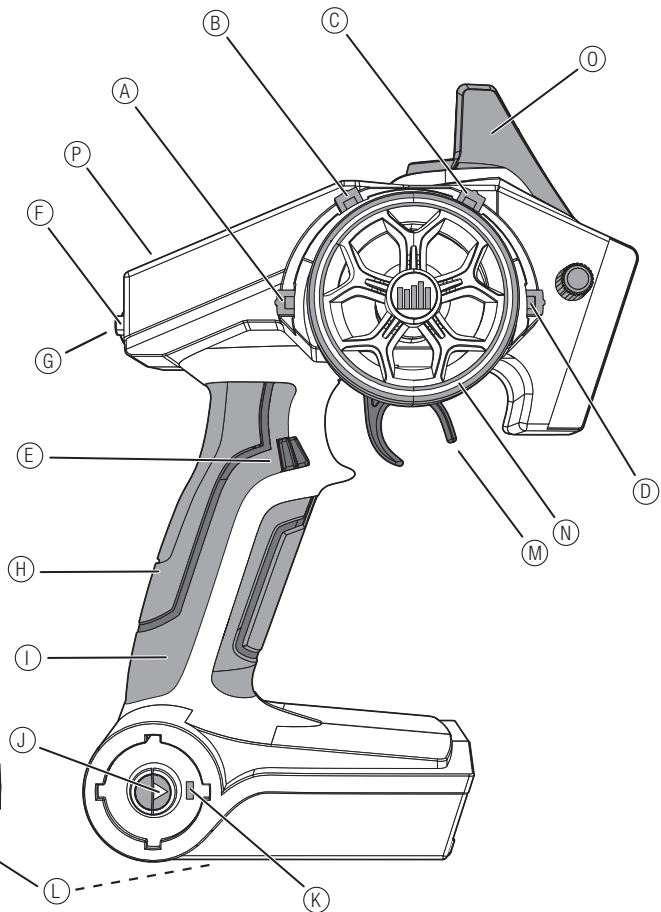
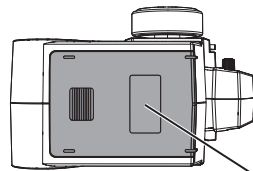

INSTALLING BATTERIES

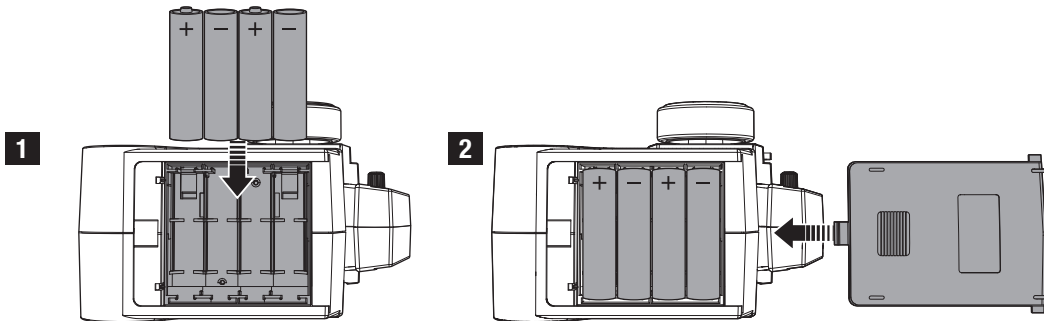

CAUTION: NEVER remove the transmitter batteries while the model is powered on. Loss of model control, damage or injury may occur.



CAUTION: If using rechargeable batteries, charge only rechargeable batteries. Charging non-rechargeable batteries may cause the batteries to burst, resulting in injury to persons and/or damage to property.

Installing Optional Li-Po Battery Pack

IMPORTANT: Set the transmitter battery type to LiPo in the System/Alert menu and ensure the battery voltage alert is set to the proper voltage. See the *System* section for more details.

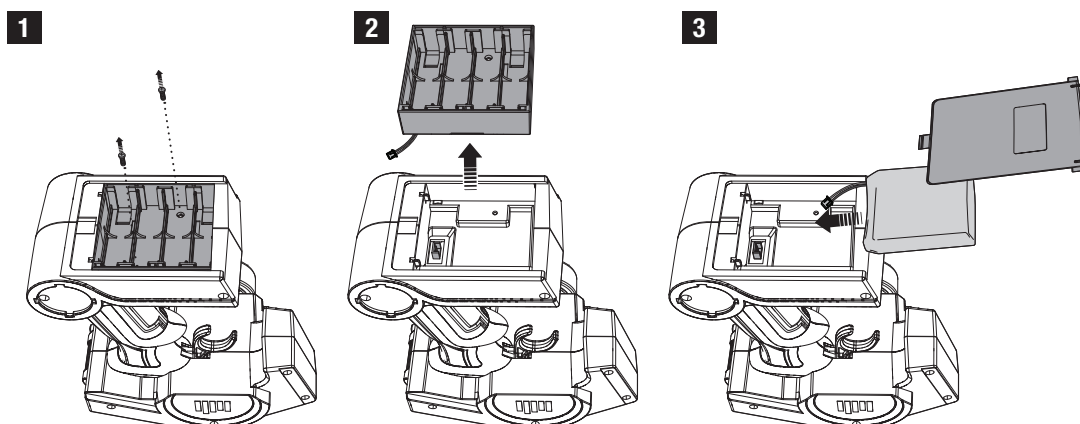

Changing the Rubber Grip

This transmitter includes 3 sizes of grips. The medium-size grip is installed at the factory. Inside the grip is a letter size: L for large, M for medium and S for small.

To change the rubber grip:

1. Lift the edge of the grip and pull the grip away from the handle.
2. Align the tabs on the new grip with the slots in the handle.
3. Press the grip against the handle.

Updating the Firmware

The DX4S features an SD card reader, enabling you to update the transmitter when firmware updates are available. Register your transmitter at Community.SpektrumRC.com to receive the latest information regarding firmware updates. To install firmware updates on your DX4S transmitter:

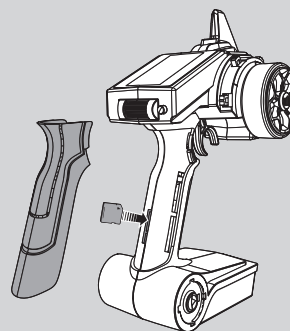

1. Remove the grip from the back of the transmitter handle.
2. Download the latest firmware from Community.SpektrumRC.com to an SD card. The transmitter serial number can be found by going to the About screen.
3. Install the SD card in the card reader slot on the DX4S transmitter.
4. Power on the transmitter. A Spektrum logo and an installation bar will appear. Installation is complete when the Main screen appears.
5. Remove the SD card from the card slot on the transmitter.
6. Reinstall the rubber grip on the transmitter handle.

ModelMatch

The Spektrum DX4S transmitter features ModelMatch™ technology, preventing you from operating a vehicle when the wrong model memory is active in the transmitter. If you select the wrong model memory, the receiver will not respond to the transmitter.

WARNING SCREENS

Low Battery Alarm

An alarm will sound and a warning screen will show when the transmitter's battery power falls below a set limit. This alarm reminds the user to bring the model under full control, power off the transmitter and replace the batteries. Press the Roller to stop the alarm and go to the *Main Screen*.

Set the low battery limit using the *System Screen*.

CAUTION: If you decide to use the optional Li-Po battery back, never allow the battery voltage to fall below 6.4V.

- A Warning title
- B Battery voltage, which is under the set limit
- C Animated arrow pointing to Roller below the screen
- D Image of roller below the screen

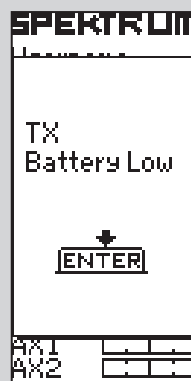

Warning
Inactivity

Inactivity Alarm

The alarm reminds users to power off the transmitter and save battery power. If the transmitter is powered on for more than 10 minutes and no control movement is detected, the inactivity alarm will activate. Moving any control stops the alarm. After one hour of inactivity, the transmitter will automatically shut down to save battery life. To turn the transmitter on again, push the power button off, then on.

MAIN SCREEN

The Main Screen displays information about the active model, including the Timer (when activated).

To return to the Main Screen at any time, press and hold the Rolling Selector for at least 3 seconds.

- A User Name
- B Active Model memory number (30 available)
- C Name assigned to the Model memory
- D Timer (when activated)
- E Transmitter battery voltage
- F Steering Percent
- G Brake Percent
- H Position of Steering (St) trim
- I Position of Throttle (Th) trim
- J Position of Aux 1 trim
- K Position of Aux 2 trim

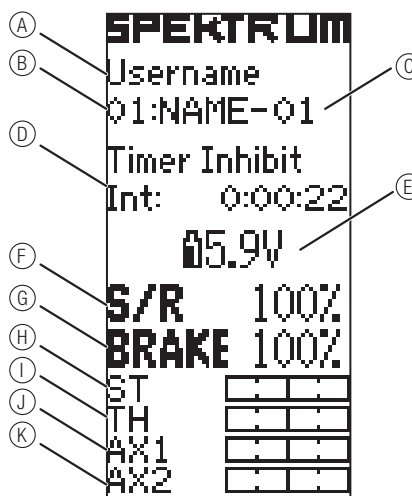

PROGRAMMING GUIDE

Using the Rolling Selector

Press the Selector to enter a highlighted function.

Roll the Selector to highlight a function, or change settings and values when selected.

Press and hold the Selector for more than 3 seconds in any screen to return the display to the List Screen or the Main Screen.

To program, always start with a press on the Selector, then roll, then press, then roll, and so on.

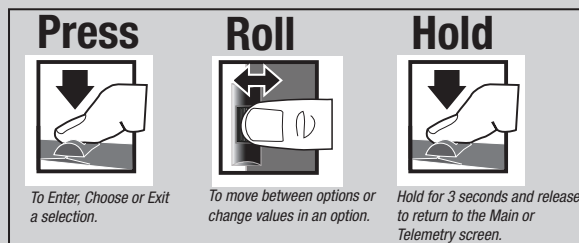

Individual Direction Adjustments

In some instances, you may find it necessary to independently adjust the control directions; for example, if you want more travel for left steering than right steering, perform the following steps:

1. Scroll to the value you wish to change and press the Rolling Selector.

2. When both directions are selected, move the control (steering or throttle) toward the control direction you wish to change. The selection box moves to the desired direction. You do not need to hold the control in the desired direction.
3. To change the opposite direction, simply move the control in that direction.
4. Press the Rolling Selector to save the selection.

LIST

The List Screen shows other screens to set programming in the transmitter.

- A dark box **(A)** with a clear symbol or text represents the highlighted selection.
- The Active Screen name **(B)** is displayed at the top of the screen.
- Choosing this arrow **(C)** will open the next higher screen, such as the Main Screen or List Screen.
- A small bar **(D)** shows the relative position of a highlighted screen name in the List.

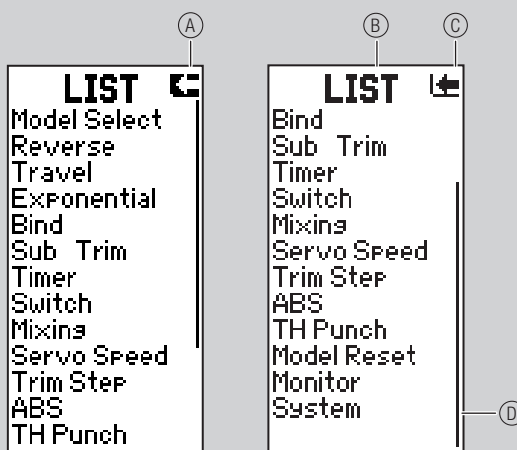

Model Select

Use the Model Select menu to change the model memory, to assign a model name or to copy a model. The DX4S has 30 model memories available.



CAUTION: NEVER change the model in Model Select while operating a model. Changing the model memory interrupts the transmitter signal to the receiver and may cause loss of vehicle control, damage or personal injury.

Model Name

Enables you to name the selected model memory using up to eight characters.

1. Use the roller to select a Model Name in the List.
2. Select the character you want to change. A list of characters appear.
3. Select the character you want to use.
4. When you are finished naming the model memory, select the arrow to save the name and return to the list.

Copy

The Copy function shares active model memory settings with a selected model memory space. This is useful for saving setups for one model to adjust programming for track conditions or model setups.

Choosing **No** returns to the List Screen. Choosing **Yes** saves the active model settings to the selected model memory.

A Active or source model memory number

B Destination model memory number

IMPORTANT: When using the Copy function, model information will be permanently overwritten by the active model settings.

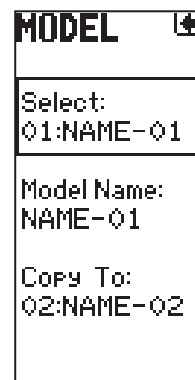
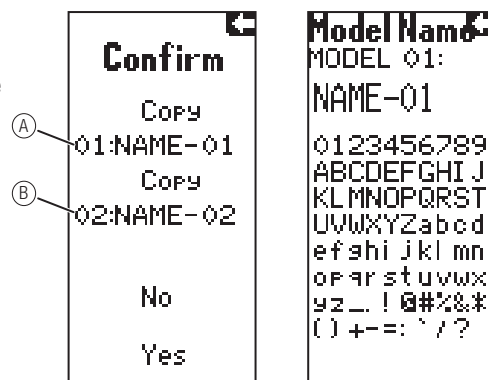

Reverse

The Reverse function, also known as servo reversing, establishes the channel direction relative to the channel input. Use the reverse menu if, for example, the wheels turn left when you turn the steering wheel to the right. Reverse is available on all channels and is normally the first function you should test and adjust during programming.

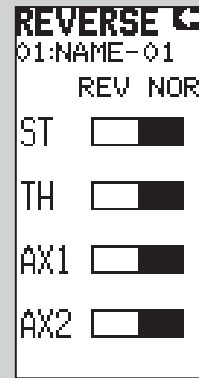

Travel

The Travel function supports precise endpoint adjustments in all channels. Travel values range from 0–150% (Default is 100%).

NOTICE: Always check the control directions at the extents of travel to be sure the linkages do not bind. Travel values that are too high will cause binding, which may result in damage to the vehicle.

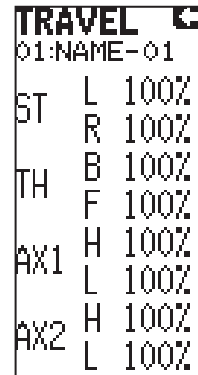

Channel	Top	Bottom
Steering	L (left)	R (right)
Throttle	B (brake)	F (forward)
Aux 1	H (high)	L (low)
Aux 2	H (high)	L (low)

Exponential

The Exponential (Expo) function affects the response rate of the steering, throttle and/or brake. A positive Steering Expo value, for example, decreases steering sensitivity around neutral to make it easier to drive at high speeds in a straight line while still allowing for maximum turning radius. While sensitivity with positive Expo is decreased around neutral, it increases the sensitivity near the end of travel.

*Reference chart for options available on each channel:

Channel	Top	Bottom
Steering	L (left)	R (right)
Throttle	B (brake)	F (forward)
Aux 1	H (high)	L (low)
Aux 2	H (high)	L (low)

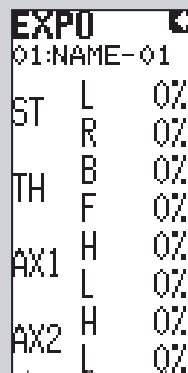

- A** Channel: *Steering, Throttle or Aux (auxiliary)*
- B** Direction
- C** Adjustable value (from -100% to +100% (0 is factory default or inhibit))



IMPORTANT: Both positive and negative Expo values are available. A positive Expo value results in the center being less sensitive (desirable most of the time), while a negative value increases the sensitivity around center (normally not used).

RECEIVER COMPATIBILITY

The DX4S transmitter is compatible with Spektrum™ DSMR™ and DSM2®. The included Spektrum SRS4210 DSMR Surface receiver is compatible with all Spektrum DSMR transmitters and is also backwards compatible with DSM2 transmitters. The SR410 DSMR receiver is only compatible with DSMR transmitters.

AVC – Active Vehicle Control

AVC® technology is the newest Spektrum™ RC innovation from Horizon Hobby. This Spektrum stabilization system adds a whole new level of control to your RC driving experience. AVC technology utilizes sensors to adjust steering and throttle output, providing you with a more stable and controlled driving experience.

NOTICE: You must use digital servos with the SRS4210 receiver. Using analog servos will reduce the performance of the system and may cause analog servos to overheat.

SR410 Receiver Installation

Install the receiver in your vehicle using double-sided foam servo tape. Foam servo tape holds the receiver in place and protects the receiver from vibration. Position the antenna vertically and away from the vehicle in an antenna tube. The SR410 and SRS4210 have a coax style antenna. The last 31mm of the antenna is the portion that receives the signal from the transmitter.

SRS4210 Receiver Connection and Installation

You must install the SRS4210 receiver in the vehicle before binding the transmitter and receiver. The receiver can be mounted flat with the label up or on its side. When you bind the receiver, the AVC system automatically detects the orientation of the receiver. The receiver must be mounted completely flat when in the label-up orientation or completely perpendicular when mounted on its side. If the receiver is angled even slightly, AVC may not function properly. If the orientation of the receiver is changed after binding, you must then rebind for AVC to function properly.

Install the Receiver in your vehicle using the included double-sided foam servo tape. Foam servo tape will hold the receiver in place and help isolate it from vibrations.

IMPORTANT: Do not use hook and loop material to install the SRS4210 receiver. Using hook and loop material will affect the performance of the AVC system.

Mount the antenna up and away from the vehicle in an antenna tube. The higher up the antenna is, the better signal it will receive.

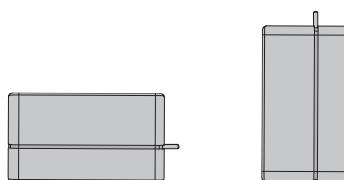

NOTICE: Do not cut or modify the antenna.

Aux channels

The Aux channels can operate as additional servo channels, or as a power supply for a personal transponder. If AVC is active, only two channels, Steering and Throttle, are operational. The Aux channels can be used to power a personal transponder or lights.

If AVC is disabled (see DISABLING THE STABILITY ASSIST FUNCTION to disable AVC), the Aux channels will operate as servo channels.



Electric Vehicle Installation

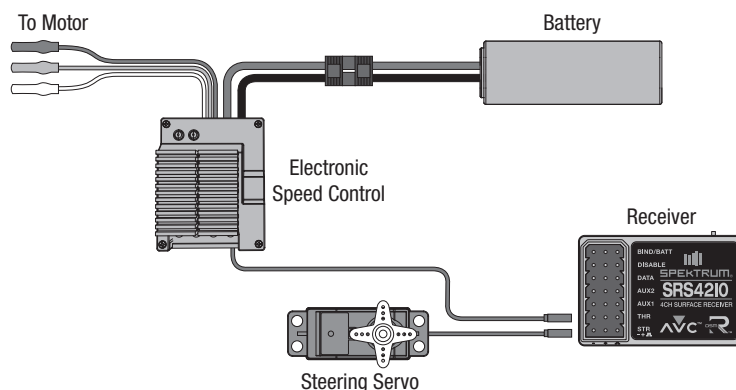

Typical Nitro Vehicle Installation

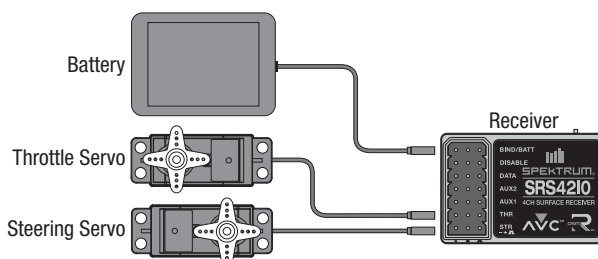

IMPORTANT: If you adjust the steering and throttle trim on your transmitter, the receiver must be turned off and back on again in order to save the new trim settings. Otherwise, AVc will not function properly.

Failsafe

The throttle failsafe position is set during binding. In the unlikely event that the radio link is lost during use, the receiver will drive the throttle servo to its pre-programmed failsafe position (normally full brakes) and all other channels will have no servo output. If the receiver is turned on prior to turning on the transmitter, the receiver will enter the failsafe mode, driving the throttle servo to its preset failsafe position. When the transmitter is turned on, normal control is resumed.

IMPORTANT: Failsafe activates only in the event that the signal is lost from the transmitter. Failsafe will NOT activate in the event that receiver battery power decreases below the recommended minimums or power to the receiver is lost.

The Bind Screen shows the active model and supports binding the active model memory to a receiver.

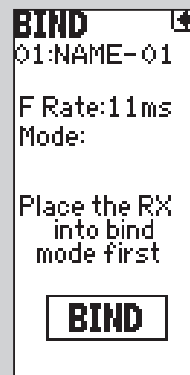

Bind

Binding is the process of teaching the receiver the specific transmitter's code called GUID (Globally Unique Identifier) and storing failsafe values. When a receiver is bound to a transmitter/model memory, the receiver will only respond to that specific transmitter/model memory (see ModelMatch for more information).

Bind Transmitter to SR410 Receiver

1. Insert a bind plug in the receiver's BIND port.
2. Power on the receiver and wait until the receiver LED begins flashing.
3. Power on the transmitter.
4. Select the Model Memory you wish to bind to.
5. Select Bind from the List menu.
6. Move the throttle channel to the desired failsafe position.

IMPORTANT: The throttle channel must stay in the failsafe position until binding is complete.

7. Scroll to Bind and press the Rolling Selector. The orange LED flashes on top of the transmitter.
8. When the bind process is complete, the transmitter and receiver LEDs stop flashing and turn solid orange.

NOTICE: Always remove the bind plug from the receiver when the bind process is complete. Failure to do so will cause the receiver to enter bind mode the next time you power on the receiver.

Binding and Calibrating the SRS4210 Receiver

You must calibrate the receiver each time it is placed in bind mode.

IMPORTANT: The following sequence of steps must be followed in order for AVC to function properly.

1. Insert the Bind Plug in the BIND port on the receiver.
2. Power on the receiver. The orange LED flashes, indicating the receiver is in bind mode.
3. Center the ST TRIM and TH TRIM on the transmitter.
4. Put your transmitter in bind mode.
5. The bind process is complete when the orange LED on the receiver is solid.
6. Pull the transmitter trigger to Full Throttle.
7. Push the transmitter trigger to Full Brake, then return the trigger to center.
8. Turn the transmitter steering wheel to Full Right.
9. Turn the transmitter steering wheel to Full Left, then return the steering wheel to center. The orange LED flashes once.
10. Remove the bind plug once the calibration and binding process is complete.
11. Power off the transmitter.

IMPORTANT: You must rebind the transmitter and receiver if you:

- Change the servo reverse after binding
- Change the travel after binding
- Want to use the receiver with a different model memory

If you change the servo reversing or travel adjust after binding, AVC will not work properly.

Disabling the Stability Assist Function

If you participate in organized racing, you may be required to turn AVC technology off. To turn off AVC technology, insert a second Bind Plug in the Disable port before binding.

IMPORTANT: You must calibrate the receiver each time it is placed in bind mode. To activate AVC, see the steps in BINDING AND CALIBRATING THE RECEIVER.

Sub-Trim

The Sub-Trim function enables you to correct minor servo arm offsets by electronically adjusting the center point of the servo. Sub-trim is available on all channels.



CAUTION: Only use small sub-trim values so you do not exceed the maximum servo travel. If you find the servo requires a large amount of sub-trim, return the sub-trim to 0 and adjust the servo arm on the servo spline manually.

*Reference chart for options available for each channel:

Channel	Description	
Steering	L (left)	R (right)
Throttle	B (brake)	F (forward)
Aux 1	H (high)	L (low)
Aux 2	H (high)	L (low)

SUB TRIM	
01:NAME-01	
ST	0
TH	0
AX1	0
AX2	0

Timer

The transmitter Timer can function as either an Up or Down Timer.

Down Timer (default selection)

The Down Timer allows you to adjust the amount of time in 10 second increments to a maximum of 21 minutes, which will then start a countdown to "0" once activated. The Down Timer value is normally the length of a race or vehicle run time. The Down Timer can be reset by selecting Timer Reset or by holding the switch that is assigned to that timer for 3 seconds.

Up Timer

The Up Timer functions as a stopwatch and is useful for determining the available run time in one tank of fuel or a battery pack.

Using the Timer

1. Assign the timer to a switch or button in the Switch menu.
2. To start or stop the timer, hold the assigned button.
3. To reset the timer, press the timer button for more than 3 seconds.

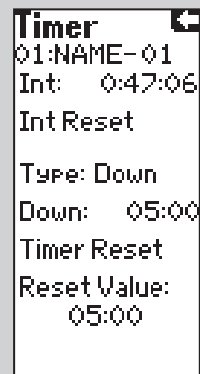

Switch

The Switch menu enables you to assign any of the seven switches to one of the following functions. Switches that have a +/- next to the name can be assigned to different directions. For example, ST trim+ causes right steering trim to trim the steering to the right. ST trim- trims the steering to the left.

Aux1 and Aux2 can only be assigned to one function at a time. For example, if Aux1 is assigned to 4WS Mix, then it will not be available as an option on the switch screen.

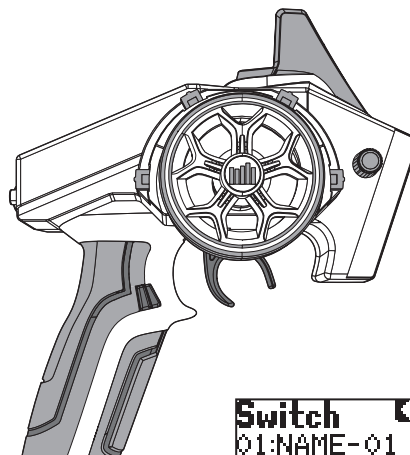

Switch A, B, C, D and E

Inhibit – Switch off

AX1 Lin – Ch 3 Linear

AX1 2P – Ch 3 2-position

AX1 3P – Ch 3 3-position

AX1 MT – Ch 3 Momentary

AX2 Lin – Ch 4 Linear

AX2 2P – Ch 4 2-Position

AX2 3P – Ch 4 3-Position

AX2 MT – Ch 4 Momentary

ST Trim+ – Steering Trim

ST Trim- – Steering Trim

TH Trim+ – Throttle Trim

TH Trim- – Throttle Trim

AX1 Trim+ – Ch 3 Trim

AX1 Trim- – Ch 3 Trim

AX2 Trim+ – Ch 4 Trim

AX2 Trim- – Ch 4 Trim

Brake+ – Full Brake Trim

Brake- – Full Brake Trim

ST Rate+ – Steering Rate

ST Rate- – Steering Rate

ROSS – Remote Start

Timer – Up or Down Timer

4WS Mix – 4 Wheel Steer

BAK Mix – Brake Mix

Mix A – Mix A Function

Mix B – Mix B Function

Mix A Rate – Mix A Value

Mix B Rate – Mix B Value

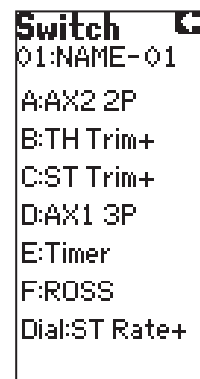

Switch F

Inhibit

AX1 2P

AX1 MT

AX2 2P

AX2 MT

ROSS

Timer

4WS Mix

Mix A

Mix B

Dial

AX1 Lin

AX2 Lin

ST Trim+

ST Trim-

TH Trim+

TH Trim-

AX1 Trim+

AX1 Trim-

AX2 Trim+

AX2 Trim-

Brake+

Brake-

ST Rate+

St Rate-

Mixing

The DX4S features a Steer Mix, Brake Mix and two programmable mixes (Mix A and Mix B).

Steer Mix

Use the Steer Mix for vehicles requiring either four-wheel steering (4WS) or dual steering servos (Dual ST).

NOTICE: Before driving a model, always do a check of the transmitter's control of the vehicle with the vehicle's wheels off the ground.

Mix Options

1. Select AX1 or AX2 as the slave channel. Aux1 and Aux2 can only be assigned to one mix at a time. If Aux1 or Aux 2 is assigned to another mix, it will not be available as a slave channel option.
2. Adjust the A Value. The value shown is the percentage of slave channel input compared to master channel input.

For example, 100% means the slave channel movement is equal to the master channel movement. If you adjust the value to 50%, the slave channel moves half as far as the master channel. A negative value means the mix moves in the opposite direction.

4-Wheel Steer Mix

Mix options:

- 4-Wheel Steer
- Front Steer
- Crab Steering
- Rear Steer

1. Scroll to Mixing, then select Steer Mix.
2. Select 4WS.
3. Select Inh, then scroll to activate the 4WS mix on Aux 1 or Aux 2.
4. To inhibit a Mix Option, scroll to the steering option, then select Inh. When a steering option is inhibited, the switch ignores the option. All steering options are active by default.

5. Adjust the steering rate for the 4-Wheel Steering options (4WS and Crab)

The values shown in the 4WS screen are the rear steering rate values.

For example, "100/100" means the rear steering rate is 100% of the front steering value. "50/50" means the rear steering rate is 50% of the front steering value in both the left and right directions.

6. Activate/Deactivate Trim (4-Wheel Steering Only)

When Trim is active, the steering trim switch adjusts both the front and rear steering trim. If Trim is inhibited, the steering trim button only affects the front steering.

7. **Switch:** Assign the 4-Wheel Steering Options to a switch. Each time you move the switch, the 4-Wheel Steering options appear on the Main Screen.

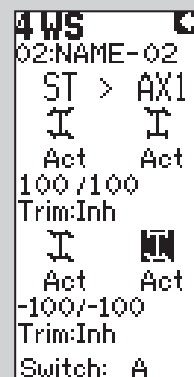
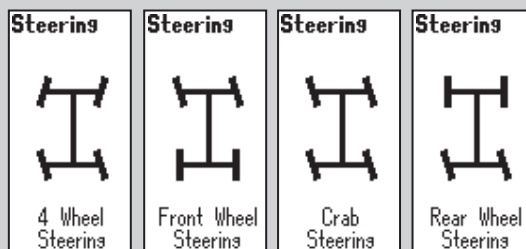

Dual ST (Dual Steering)

Trim: Act (Default) or Inh. We recommend activating the Trim, as it adjusts the trim for both the left and right steering servos. If you need to make small adjustments to the individual servos, you can do so in the Sub-Trim menu.

Switch: You may assign the Dual ST mix to a switch, enabling a B Value in the mix. Assigning the Dual ST mix to a switch is valuable when you want to assign dual steer values for different conditions. For example, you may use a smaller value when the vehicle is moving faster. When the vehicle is moving slowly, use the switch to select the larger value and increase steering ability. You can also set one of the mix values to 0% if you want to turn the mix off.

Brake Mix

Use the Brake Mix on large scale vehicles that require separate front and rear brake servos. The mix value creates brake bias between the front and rear brakes. Assigning the Brake Mix to a switch enables you to adjust the mix value from any screen.

1. Select AX1 or AX2 as the Slave channel. If Aux 1 or Aux 2 is assigned to another mix, it will not be available as a Slave channel option.
2. Adjust the Brake Mix Value to establish the brake bias between the front and rear brakes. *Switch:* You may assign the Brake Mix to a switch. Assigning the Brake Mix to a switch enables you to adjust the brake bias from any screen.

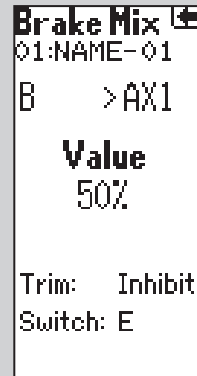

Motor On Axle (MOA) Throttle Mix

The MOA Throttle Mix is used to adjust the throttle bias on rock crawlers using a “motor on axle” configuration.

Mix options:

- Rear Dig
- Front Dig
- 4WD

1. Select MOA from the Throttle Mix menu.
2. Scroll to Inh. Press the scroll wheel, then scroll to activate the mix. Press the scroll wheel again to adjust the mix.
3. **To inhibit an option**
Scroll to the MOA option, then select Inh. All MOA options are active by default. If you inhibit an option, the Mix switch ignores the option.
4. **Adjust the Throttle Bias Value (4WD Only)**

The value shown on the screen is a percentage of the rear motor rate. For example, a value of “70%” means the rear motor power is 70% of the front motor power.

5. In Motion Adjustment

You can assign the throttle bias to the following switches:

- A • C • E
- B • D • Dial

Assigning the Throttle Bias to a switch enables you to adjust the throttle bias while the vehicle is moving.

6. Assigning the Mix Options to a Switch

Assign the MOA Options to a switch. Each time you move the Mix switch, the MOA options appear on the Main Screen.

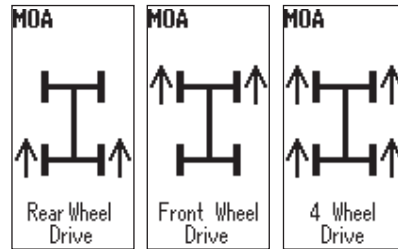

Main Screen

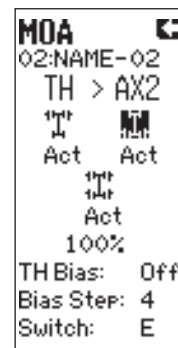

MOA Mix Screen

Bias Step:

The Bias Step affects the amount the mix changes with each click of the button or dial but has no effect on the total mix range.

Active Vehicle Control (AVC)

Options:

- ST Gain
- TH Gain
- Priority

1. Select AVC from the LIST menu.

2. Change the State field to ACT.

3. Adjust the ST Gain and/or TH Gain Sensitivity

The default value is 0% (ST Gain and TH Gain OFF). As the value increases, the AVC steering stability and throttle management increases.

Adjust the ST Gain until you reach the ideal amount of steering control. If the front wheels begin to shake, the ST Gain value is too high. Reduce the ST Gain value until the front wheels stop shaking. You can assign ST Gain and TH Gain to the same switch, enabling you to adjust both values at the same time.

4. **Switch:** Assigning ST Gain and TH Gain to a switch enables you to adjust the sensitivity without using the AVC menu. ST GAIN and TH GAIN can be assigned to the same switch to adjust both simultaneously.

5. Adjust the Steering Priority

The Priority default value is 0%, meaning AVC is active when the steering is close to center. As you turn the steering wheel away from center (neutral), the transmitter controls have priority over the AVC system. Increasing the Priority value decreases how active AVC is as the steering wheel is turned left and right. For example, if you increase Priority to 80%, you reduce the AVC steering control by 80% at full left or full right steering. Increasing the Steering Priority enables you to make tighter turns.

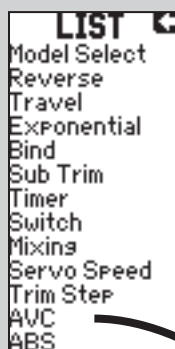

List Menu

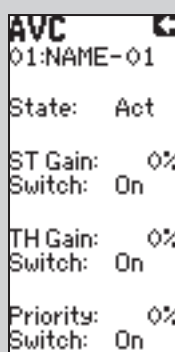

AVC Screen

ST Gain when active drives the Aux 1

TH Gain when active drives the Aux 2

Priority adjusts ST Gain based on the steering input

Programmable Mix

The programmable mixes enable you to assign any channel as a Master or Slave, which is particularly helpful when you need to assign an Aux channel as a Master.

1. Scroll to Inh. Press the rolling selector once and select a Master channel.
2. Select a Slave channel.
3. Adjust the A Value percentage.

You can assign custom names to Mix A and Mix B, making it easier to remember what each mix does. Assign the names the same way you would for the Username or Model Name.

Mix Options

Trim: Inh or Act. When Trim is Active, trim adjustments to the Master channel also apply to the Slave channel.

Switch: You may assign the mix to a switch, enabling a B Value in the mix.

To adjust the B Value:

1. Assign a switch to the mix.
2. Press the switch forward or back. The A Value changes to B Value on the screen.
3. Select the B Value and move the scroll wheel to adjust the value.
4. Press the Rolling Selector to save the selection.

NOTICE: Before driving a model, always do a check of the model's response to mix settings. Raise the vehicle off the ground so it does not move during testing.

IMPORTANT: A negative value results in the secondary channel moving in a direction opposite the direction of the primary channel.

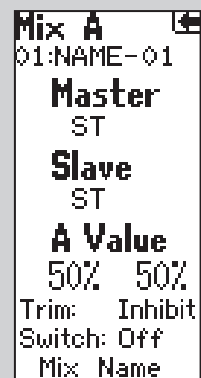

Servo Speed

The Servo Speed function allows you to change the speed of any of the four channels—steering, throttle and Aux. from 100% (default) to 1%. The maximum speed is 100% and is fixed by the specifications of the servo itself.

- In the List screen, use the roller to highlight the Servo Speed function. Press the roller to access the Servo Speed function. The Servo Speed screen appears.
- Use the roller to select the desired channel, then press the roller to access that channel. Rotate the roller to adjust the servo speed.

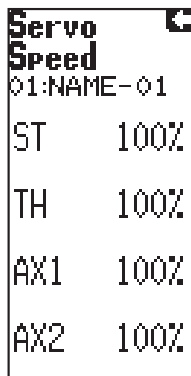

Trim Step

Trim Step affects the amount the servo travels with each click of the trim, but has no effect on the total trim travel. The trim steps range from 1 to 20 (Default is 4). To adjust the trim step:

1. Select Trim Step from the List menu.
2. Scroll to the desired channel and press the scroll wheel to activate the channel.
3. Rotate the scroll wheel to adjust the trim step.
4. Press the scroll wheel to save the selection.

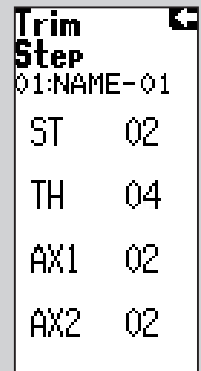

ABS (Automatic Breaking System or Pulse Brakes)

ABS helps prevent brake lock-ups and improves braking performance by pulsing the brakes.

The following ABS braking parameters can be programmed:

State: Inhibit or Active

Point: The throttle position that the pulse braking takes place (0 to 100, default is 60).

Stroke: The distance the throttle travels during the pulse braking (0 to 100, default is 50).

Lag: The time delay before the pulsing takes place (0.0 to 2.0 in .01 increments, default is 0.5).

Speed: The pulsing speed or frequency of the pulse braking (-1 to -30, default is -1).

IMPORTANT: State must be Active to turn on the ABS function.

- In the List screen, use the roller to highlight the ABS function.
- Press the roller to access the ABS function. The ABS screen appears.
- Use the roller to select the ABS parameter you wish to adjust.
- Press the roller to highlight that parameter and the associated box will flash. Rotate the roller to adjust that function.

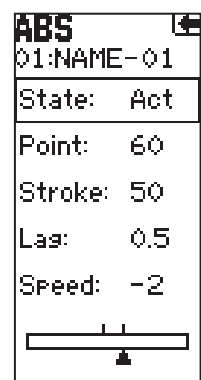

The graphic bar at the bottom of the screen displays the parameters and shows how ABS will function.

Throttle Punch

The Throttle Punch function is used to offset the throttle to a preprogrammed position and activate when 4% of throttle travel is applied. Throttle punch is typically used in nitro vehicles to reduce the lag due to throttle linkage slack.

To Access the Throttle Punch Function:

- In the List screen, use the Rolling Selector to highlight the Th Punch function.
- Press the Rolling Selector to access the Throttle Punch function. The above screen will appear.
- Use the Rolling Selector and place a box around Th Punch. Press the Rolling Selector and the surrounding box will flash, then rotate the Rolling Selector to adjust the value of the throttle punch position. Press the Rolling Selector.

IMPORTANT: Throttle punch will remain active until the value is reset to zero. To return to the main screen, press and hold the Rolling Selector for more than three seconds.

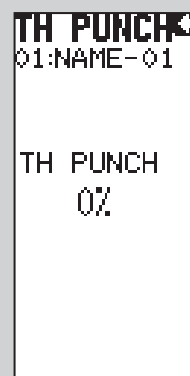

Reset

The Model Reset function restores factory default settings for the active model memory.

- Choosing **Yes** affirms erasing saved settings for the active model memory and return of factory defaults. A box shows around selected text.
- Choosing **No** returns to the List Screen.

IMPORTANT: Model information saved in a memory is erased when that model memory is copied over or reset to factory default settings.

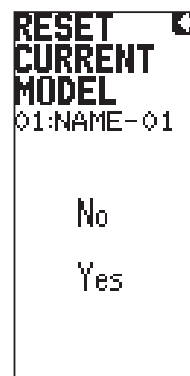

Monitor

The servo monitor displays the servo output positions graphically and digitally. This monitor can be useful in troubleshooting setups, displaying mixing functions and how they interrelate.

- In the List screen, use the roller to highlight the Monitor function.
- Press the roller to access the Monitor function. The real-time servo output positions will display.

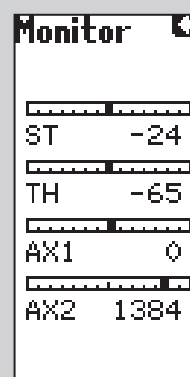

System

The System function lets you adjust transmitter functions.

List

Two modes are available: Expert and Standard. The DX4S defaults to Expert where all of the programming menus are available. Standard mode eliminates the expert screens and functions from the list, making it ideal for basic models.

Display

Contrast

The contrast function provides adjustment to the brightness ratio of the lightest to the darkest part of the screen. You can set the contrast to a value from 0 to 30 (0 is lightest and 30 is darkest).

Light

You can set the backlight to one of three modes: Timer, On or Off.

- **Timer:** The backlight will turn off after a preset delay.
- **On:** The backlight never turns off when the transmitter is on.
- **Off:** The backlight is always off.

1. Use the Rolling Selector to access Light.
2. Press the roller and the surrounding box will flash.
3. Rotate the roller to the desired backlight mode and press the roller to select it.

Lang (Language)

The DX4S can display the screen text in one of four languages: English (default), German, French, and Italian. Use the roller and select the Language function.

Alert

You can set an alarm to sound when the battery voltage gets to the limit set with the Alert. Battery voltage is displayed on the Main Screen.

Menu: None, Tone, Vibe, Both Sets the alert type for scrolling through the menu items and selecting items.

Tone: You can adjust the buzzer to either *Low* or *High*

IMPORTANT: Buzzer adjustment does not change the sound level for Inactivity or Low Battery warnings.

Tx Battery Voltage: Set an alarm to sound when the battery voltage reaches the limit.

Battery voltage options are Alkaline, Ni-MH or Li-Po. After you select the battery type, you can raise the voltage limit.

Tx Battery Alert Type: None, Tone

Timer: None, Tone, Vibe, Both Sets the alert type for the down timer.

All of the alert settings above affect all models.

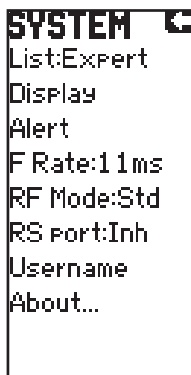

F Rate (Frame Rate)

Frame rate is the response rate of the receiver. The lower the number, the faster the response. Frame rate only affects the current model.

IMPORTANT: You should always use the fastest response rate the servos can handle. This gives the lowest latency and fastest response. If the frame rate is incompatible with the servo, the servo will move erratically or in some cases not at all. If this occurs, change the frame rate to the next highest value.

The available frame rates will depend on the type of receiver the DX4S is bound to:

DSMR: 11 or 22ms

DSM2: 16.5ms

1. Use the roller to highlight the F Rate function.
2. Press the roller.
3. Rotate the roller to select the frame rate and press the roller to save the selection.

RS Port

This sets the port – (*Bind* or *Aux* (Auxiliary)) – on the receiver for ROSS (Remote Onboard Starting System) connection. RS Port is model specific.

Username

You can program a user name with up to 8 characters. This name is displayed on the Main Screen. In the System screen, highlight the User Name and press the roller to access the function. Use the roller to select the position, then press the roller to access a character. Username affects all models.

About

This screen displays the transmitter serial number (which is required when downloading firmware updates) and the release level of the transmitter's software. Refer to Memory Card instructions for updating transmitter firmware.

TROUBLESHOOTING GUIDE

Problem	Possible Cause	Solution
The system will not connect	Transmitter and receiver too near each other	Move transmitter 8 to 12 feet (2.4 to 3.6m) from receiver
	Transmitter and receiver too near large metal objects (vehicles, etc.)	Move away from large metal objects (vehicles, etc.)
	Selected model is not bound in transmitter	Make sure correct model memory is selected and that transmitter is bound to the model
	Transmitter accidentally put in bind mode so receiver is no longer bound	Rebind transmitter and receiver
The receiver goes into failsafe mode a short distance away from the transmitter	Check the receiver antenna to be sure it is not cut or damaged	Replace or contact Horizon Product Support
		Make sure receiver antenna is in an antenna tube and is above vehicle
Receiver quits responding during operation	Low battery voltage	Completely recharge battery
	Loose or damaged wires or connectors between battery and receiver	Do a check of the wires and connection between battery and receiver. Repair or replace wires and/or connectors
Receiver loses its bind	Transmitter accidentally put in bind mode, ending bind to receiver	Bind transmitter to receiver
The front wheels oscillate	The steering gain is set too high	Turn down the steering gain
The front wheels turn the wrong way when the car slides/rotates	The steering channel was reversed after calibration	Rebind and calibrate
The throttle does not reduce when the car slides/rotates	The throttle channel was reversed after calibration	Rebind and calibrate

1-YEAR LIMITED WARRANTY

What this Warranty Covers

Horizon Hobby, LLC (Horizon) warrants to the original purchaser that the product purchased (the "Product") will be free from defects in materials and workmanship for a period of 1 year from the date of purchase.

What is Not Covered

This warranty is not transferable and does not cover (i) cosmetic damage, (ii) damage due to acts of God, accident, misuse, abuse, negligence, commercial use, or due to improper use, installation, operation or maintenance, (iii) modification of or to any part of the Product, (iv) attempted service by anyone other than a Horizon Hobby authorized service center, (v) Product not purchased from an authorized Horizon dealer, or (vi) Product not compliant with applicable technical regulations.

OTHER THAN THE EXPRESS WARRANTY ABOVE, HORIZON MAKES NO OTHER WARRANTY OR REPRESENTATION, AND HEREBY DISCLAIMS ANY AND ALL IMPLIED WARRANTIES, INCLUDING, WITHOUT LIMITATION, THE IMPLIED WARRANTIES OF NON-INFRINGEMENT, MERCHANTABILITY AND FITNESS FOR A PARTICULAR PURPOSE. THE PURCHASER ACKNOWLEDGES THAT THEY ALONE HAVE DETERMINED THAT THE PRODUCT WILL SUITABLY MEET THE REQUIREMENTS OF THE PURCHASER'S INTENDED USE.

Purchaser's Remedy

Horizon's sole obligation and purchaser's sole and exclusive remedy shall be that Horizon will, at its option, either (i) service, or (ii) replace, any Product determined by Horizon to be defective. Horizon reserves the right to inspect any and all Product(s) involved in a warranty claim. Service or replacement decisions are at the sole discretion of Horizon. Proof of purchase is required for all warranty claims. SERVICE OR REPLACEMENT AS PROVIDED UNDER THIS WARRANTY IS THE PURCHASER'S SOLE AND EXCLUSIVE REMEDY.

Limitation of Liability

HORIZON SHALL NOT BE LIABLE FOR SPECIAL, INDIRECT, INCIDENTAL OR CONSEQUENTIAL DAMAGES, LOSS OF PROFITS OR PRODUCTION OR COMMERCIAL LOSS IN ANY WAY, REGARDLESS OF WHETHER SUCH CLAIM IS BASED IN CONTRACT, WARRANTY, TORT, NEGLIGENCE, STRICT LIABILITY OR ANY OTHER THEORY OF LIABILITY, EVEN IF HORIZON HAS BEEN ADVISED OF THE POSSIBILITY OF SUCH DAMAGES. Further, in no event shall the liability of Horizon exceed the individual price of the Product on which liability is asserted. As Horizon has no control over use, setup, final assembly, modification or misuse, no liability shall be assumed nor accepted for any resulting damage or injury. By the act of use, setup or assembly, the user accepts all resulting liability. If you as the purchaser or user are not prepared to accept the liability associated with the use of the Product, purchaser is advised to return the Product immediately in new and unused condition to the place of purchase.

Law

These terms are governed by Illinois law (without regard to conflict of law principals). This warranty gives you specific legal rights, and you may also have other rights which vary from state to state. Horizon reserves the right to change or modify this warranty at any time without notice.

WARRANTY SERVICES

Questions, Assistance, and Services

Your local hobby store and/or place of purchase cannot provide warranty support or service. Once assembly, setup or use of the Product has been started, you must contact your local distributor or Horizon directly. This will enable Horizon to better answer your questions and service you in the event that you may need any

assistance. For questions or assistance, please visit our website at www.horizonhobby.com, submit a Product Support Inquiry, or call the toll free telephone number referenced in the Warranty and Service Contact Information section to speak with a Product Support representative.

Inspection or Services

If this Product needs to be inspected or serviced and is compliant in the country you live and use the Product in, please use the Horizon Online Service Request submission process found on our website or call Horizon to obtain a Return Merchandise Authorization (RMA) number. Pack the Product securely using a shipping carton. Please note that original boxes may be included, but are not designed to withstand the rigors of shipping without additional protection. Ship via a carrier that provides tracking and insurance for lost or damaged parcels, as Horizon is not responsible for merchandise until it arrives and is accepted at our facility. An Online Service Request is available at http://www.horizonhobby.com/content/_service-center_render-service-center. If you do not have internet access, please contact Horizon Product Support to obtain a RMA number along with instructions for submitting your product for service. When calling Horizon, you will be asked to provide your complete name, street address, email address and phone number where you can be reached during business hours. When sending product into Horizon, please include your RMA number, a list of the included items, and a brief summary of the problem. A copy of your original sales receipt must be included for warranty consideration. Be sure your name, address, and RMA number are clearly written on the outside of the shipping carton.

NOTICE: Do not ship Li-Po batteries to Horizon. If you have any issue with a Li-Po battery, please contact the appropriate Horizon Product Support office.

Warranty Requirements

For Warranty consideration, you must include your original sales receipt verifying the proof-of-purchase date. Provided warranty conditions have been met, your Product will be serviced or replaced free of charge. Service or replacement decisions are at the sole discretion of Horizon.

Non-Warranty Service

Should your service not be covered by warranty, service will be completed and payment will be required without notification or estimate of the expense unless the expense exceeds 50% of the retail purchase cost. By submitting the item for service you are agreeing to payment of the service without notification. Service estimates are available upon request. You must include this request with your item submitted for service. Non-warranty service estimates will be billed a minimum of ½ hour of labor. In addition you will be billed for return freight. Horizon accepts money orders and cashier's checks, as well as Visa, MasterCard, American Express, and Discover cards. By submitting any item to Horizon for service, you are agreeing to Horizon's Terms and Conditions found on our website http://www.horizonhobby.com/content/_service-center_render-service-center.

ATTENTION: Horizon service is limited to Product compliant in the country of use and ownership. If received, a non-compliant Product will not be serviced. Further, the sender will be responsible for arranging return shipment of the un-serviced Product, through a carrier of the sender's choice and at the sender's expense. Horizon will hold non-compliant Product for a period of 60 days from notification, after which it will be discarded.

WARRANTY AND SERVICE CONTACT INFORMATION

Country of Purchase	Horizon Hobby	Contact Information	Address
United States of America	Horizon Service Center (Repairs and Repair Requests)	servicecenter.horizonhobby.com/ RequestForm/	4105 Fieldstone Rd Champaign, Illinois, 61822 USA
	Horizon Product Support (Product Technical Assistance)	www.quickbase.com/db/ bghj7ey8c?a=GenNewRecord	
		888-959-2306	
Sales	sales@horizonhobby.com 888-959-2306		
United Kingdom	Service/Parts/Sales: Horizon Hobby Limited	sales@horizonhobby.co.uk +44 (0) 1279 641 097	Units 1–4 , Ployters Rd, Staple Tye Harlow, Essex, CM18 7NS, United Kingdom
Germany	Horizon Technischer Service	service@horizonhobby.de	Christian-Junge-Straße 1 25337 Elmshorn, Germany
	Sales: Horizon Hobby GmbH	+49 (0) 4121 2655 100	
France	Service/Parts/Sales: Horizon Hobby SAS	infofrance@horizonhobby.com +33 (0) 1 60 18 34 90	11 Rue Georges Charpak 77127 Lieusaint, France
China	Service/Parts/Sales: Horizon Hobby – China	info@horizonhobby.com.cn +86 (021) 5180 9868	Room 506, No. 97 Changshou Rd. Shanghai, China 200060

FCC INFORMATION

This device complies with part 15 of the FCC rules. Operation is subject to the following two conditions: (1) This device may not cause harmful interference, and (2) this device must accept any interference received, including interference that may cause undesired operation.



CAUTION: Changes or modifications not expressly approved by the party responsible for compliance could void the user's authority to operate the equipment.

This product contains a radio transmitter with wireless technology which has been tested and found to be compliant with the applicable regulations governing a radio transmitter in the 2.400GHz to 2.4835GHz frequency range.

Antenna Separation Distance

When operating your Spektrum transmitter, please be sure to maintain a separation distance of at least 5 cm between your body (excluding fingers, hands, wrists, ankles and feet) and the antenna to meet RF exposure safety requirements as determined by FCC regulations.

The illustrations below show the approximate 5 cm RF exposure area and typical hand placement when operating your Spektrum transmitter.

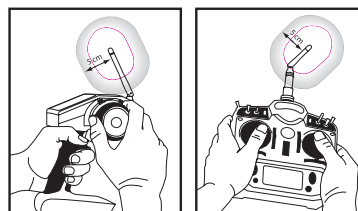

IC INFORMATION

This device complies with Industry Canada licence-exempt RSS standard(s). Operation is subject to the following two conditions: (1) this device may not cause interference, and (2) this device must accept any interference, including interference that may cause undesired operation of the device.

COMPLIANCE INFORMATION FOR THE EUROPEAN UNION

Declaration of Conformity

(in accordance with ISO/IEC 17050-1)

No. HH2012111801U1

Product(s): DX4S DSMR 4Ch AVC System

Item Number(s): SPM4010W

Equipment class: 1

The object of declaration described above is in conformity with the requirements of the specifications listed below, following the provisions of the European R&TTE directive 1999/5/EC:

EN 300-328 V1.8.1

EN 301 489-1 V1.9.2: 2012

EN 301 489-17 V2.1.1: 2009

EN 60950-1:2006+A11:2009+A1:2010+A12: 2011

EN 62311: 2008



Signed for and on behalf of:
Horizon Hobby, LLC
Champaign, IL USA
November 20, 2014

Mike Dunne
Executive Vice President
Product Divisions
Horizon Hobby, LLC



Instructions for disposal of WEEE by users in the European Union

This product must not be disposed of with other waste. Instead, it is the user's responsibility to dispose of their waste equipment by handing it over to a designated collection point for the recycling of waste electrical and electronic equipment. The separate collection and recycling of your waste equipment at the time of disposal will help to conserve natural resources and ensure that it is recycled in a manner that protects human health and the environment. For more information about where you can drop off your waste equipment for recycling, please contact your local city office, your household waste disposal service or where you purchased the product.