



**TRX RACING
ENGINES**

OWNER'S MANUAL



TRX 2.5R[™]
RACING ENGINE



TRX 3.3[™]
RACING ENGINE



TRX 2.5[™]
RACING ENGINE

TRAXXAS[™]

Traxxas
6250 Traxxas Way
McKinney, Texas 75070
Phone: 972-549-3000
Toll-free 1-888-TRAXXAS

Internet
Traxxas.com
E-mail: support@Traxxas.com

Entire contents ©2016
Traxxas. Traxxas, Top Fuel,
and Ready-To-Race are
trademarks or registered
trademarks of Traxxas. Other
brand names and marks
are the property of their
respective holders and are
used only for purposes of
identification. No part of this
manual may be reproduced
or distributed in print or
electronic media without the
express written permission
of Traxxas.

Note: This manual covers TRX 3.3, TRX 2.5, and TRX 2.5R Racing Engines. Some photos show the engine equipped with optional accessories, such as the EZ-Start system, headers, and engine mounts, that are not included in the engine package. See the end panel of the engine box for exact contents based on your engine model number.

BEFORE YOU PROCEED

Carefully read and follow all instructions in this and any accompanying materials to prevent serious damage to your engine. Failure to follow these instructions will be considered abuse and/or neglect.

Before running your engine, look over this entire manual and examine the engine carefully. If for some reason you decide it is not what you wanted, then do not continue any further. **Your hobby dealer absolutely cannot accept an engine for return or exchange after it has been run.**

Warnings, Helpful Hints, & Cross-References

Throughout this manual, you'll notice warnings and helpful hints identified by the icons below. Be sure to read them!



An important warning about personal safety or avoiding damage to your engine and related components.



Special advice from Traxxas to make things easier and more fun.



Refers you to a page with a related topic.

SUPPORT

If you have any questions about your engine or its operation, call the Traxxas Technical Support Line toll-free at: **1-888-TRAXXAS (1-888-872-9927)***

Technical support is available Monday through Friday from 8:30am to 9:00pm central time. Technical assistance is also available at Traxxas.com. You may also e-mail customer support with your question at support@Traxxas.com. Join thousands of registered members in our online community at Traxxas.com.

Traxxas offers a full-service, on-site repair facility to handle any of your Traxxas service needs. Maintenance and replacement parts may be purchased directly from Traxxas by phone or online at BuyTraxxas.com. You can save time, along with shipping and handling costs, by purchasing replacement parts from your local dealer.

Do not hesitate to contact us with any of your product support needs. We want you to be thoroughly satisfied with your new engine!

REGISTERING YOUR MODEL

In order to serve you better as our customer, please register your product within 10 days of your purchase online at Traxxas.com/register.

Traxxas.com/register

- 4 SAFETY PRECAUTIONS
- 5 INTRODUCTION
- 6 TRX RACING ENGINE ILLUSTRATED
- 7 TERMS TO KNOW
- 11 THE FUEL
- 14 THE AIR FILTER
- 16 THE CARBURETOR
- 19 BREAKING-IN YOUR TRX RACING ENGINE
- 25 TUNING YOUR TRX RACING ENGINE
- 29 TROUBLESHOOTING YOUR TRX RACING ENGINE
- 33 MAINTAINING AND STORING YOUR TRX RACING ENGINE
- 36 REBUILDING YOUR TRX RACING ENGINE
- 42 INDEX

*Toll-free support is available to U.S. residents only.



All instructions and precautions outlined in this manual should be strictly followed to ensure safe operation of your TRX Racing Engine.



TRX Racing Engines are not intended for use by children under 16 years of age without the supervision of a responsible and knowledgeable adult.

SAFETY PRECAUTIONS

All of us at Traxxas want you to safely enjoy your new TRX Racing Engine. Operate your TRX Racing Engine sensibly and with care, and it will be exciting, safe, and fun for you and those around you. Failure to operate your TRX Racing Engine in a safe and responsible manner may result in property damage and serious injury. The precautions outlined in this manual should be strictly followed to help ensure safe operation. You alone must see that the instructions are followed and the precautions are adhered to.

- **Model engine fuel is dangerous and highly poisonous.** Always follow all directions and precautions printed on the fuel container. Model engine fuel is poisonous to humans and animals. Drinking the fuel can cause blindness and death. Handle with care and respect.
- Model engine fuel, especially when in a fuel dispensing bottle, may look like a cool drink to a child. **Keep all fuel out of the reach of children at all times. Do not place fuel containers on the ground where children can reach them while you are driving.**
- Model engine fuel is flammable. Never allow smoking, sparks, heat, or flame in the presence of fuel or fuel vapors.
- The engine and exhaust system may become extremely hot during use. Be careful not to touch these parts, especially when refueling or stopping the engine.
- Prolonged exposure to the engine exhaust can be harmful. Avoid breathing the engine exhaust. Always run your nitro model outdoors, in a well-ventilated area. Never run the engine indoors.
- The engine can be loud. If the noise makes you uncomfortable, wear ear protection. Be considerate of your neighbors by not running your model early in the morning or late in the evening.
- **Most importantly, use good common sense at all times.**

INTRODUCTION

TRX Racing Engines are the next generation of TRX nitro power. The larger displacement and advanced porting generate class-leading horsepower while still maintaining the TRX Racing Engine characteristics of broad, linear power delivery and ease of tuning. Focused engineering and rigorous testing have yielded unprecedented power and uncompromising performance that turns ready-to-run into Ready-To-Race®.

TRX Racing Engines take a total-system approach. Each part of the engine, from the air filter to the exhaust tip, is carefully engineered to work in harmony with other engine components. Each part complements the next, to extract maximum power. TRX Racing Engines are designed to be tolerant of variations in tuning and running through a wide range of variable atmospheric conditions, such as changes in temperature, humidity, and altitude.

TRX Racing Engines are manufactured to exacting tolerances and require a specially-designed break-in procedure to accomplish the final precision fitting of the internal engine components. It is very important that you follow the new break-in procedure as closely as possible to achieve the best performance and longest life from your TRX Racing Engine. Old style break-in procedures, such as simply running the engine with a very rich fuel mixture for the first 4 tanks of fuel, will not achieve the best results. Follow the steps in this manual to successfully break in your TRX Racing Engine.

A routine maintenance schedule is also required to keep your TRX Racing Engine in top running condition. Cleaning the air filter after each hour of running is particularly important. Also, it is extremely important to perform after-run maintenance on the engine to prevent corrosion of the internal engine components (see page 34).



Traxxas strongly discourages changing or modifying any part of your TRX Racing Engine. Old tech tips and tricks that may have boosted the power of other engines could seriously diminish the performance of your TRX Racing Engine.

There's more advanced thinking, development, and testing in the stock parts of your TRX Racing Engine than in many aftermarket manufacturer's so-called performance parts. TRX Racing Engines are already some of the most powerful engines in their class and simply will not benefit from average, low-tech, aftermarket bolt-on performance items.

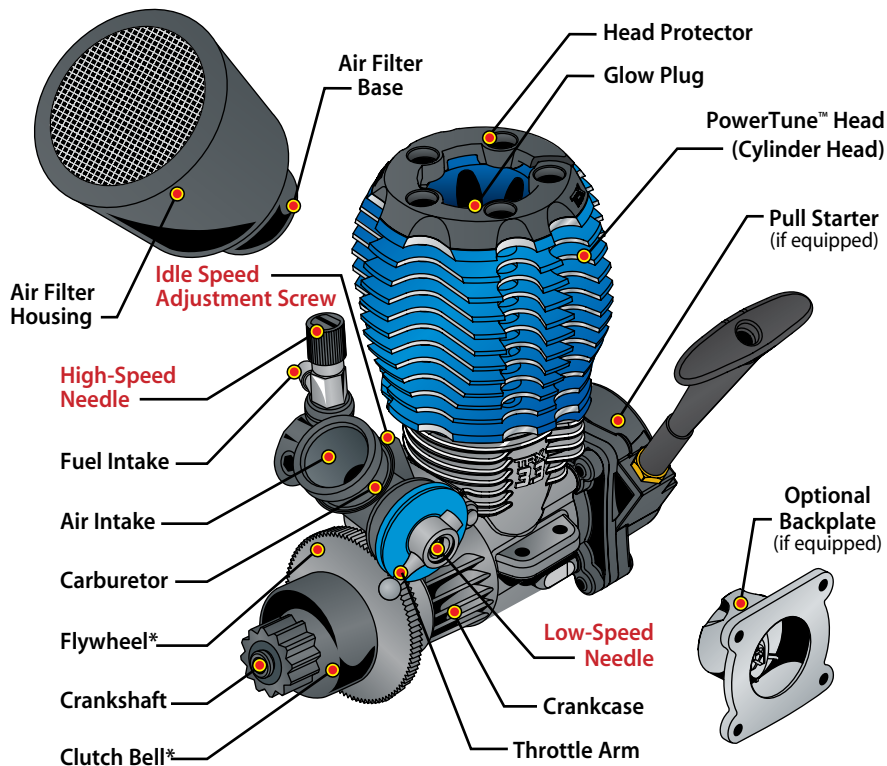

*not included

(TRX 3.3 Engine shown. Other TRX Racing Engines are very similar.)

TERMS TO KNOW

You'll find these Nitro R/C engine terms throughout this section of the manual.

.15 - .15 or "15" refers to the displacement of the engine.

The TRX 2.5 Racing Engine is .15 cubic inches or 2.5 cubic centimeters (cc). The name "TRX 2.5" is derived from the cc measurement.

.20 - .20 or "20" refers to the displacement of the engine. The TRX 3.3 is .20 cubic inches or 3.3 cubic centimeters (cc). The name "TRX 3.3" is derived from the cc measurement.

ABC - Abbreviation for aluminum, brass, and chrome. Refers to engine construction that consists of an aluminum piston that slides in a chrome-plated brass sleeve.

Air filter - The air filter sits atop the carburetor and prevents harmful dust and dirt from entering the engine. Dirt ingestion is the number one cause of premature engine failure so the engine should never be run without the air filter in place.

BDC - Bottom dead center. The bottom-most position of the engine piston stroke.

Break-in - Break-in is the procedure for running a brand new engine according to specific instructions. This correctly prepares the engine for normal running. The break-in procedure can be different for different makes of engines. Follow the Traxxas directions for break-in exactly.

Carb - Abbreviation for carburetor.

Carburetor - The carburetor atomizes (mixes) the fuel with the air so that the engine can burn it. There are two types of carburetors; slide carbs and barrel carbs. TRX Racing Engines use the superior slide carburetor design.

Clean-out - Cleaning-out is a condition that occurs when the engine is accelerating and the fuel mixture becomes sufficiently lean to allow the engine to continue into its upper RPM power band. It is usually characterized by a noticeable decrease in blue exhaust smoke and a dramatic increase in engine speed.

Combustion chamber - The combustion chamber is machined into the bottom of the cylinder head. This is where the glow plug ignites the fuel. The shape of the combustion chamber is designed to promote more efficient burning of the fuel.

Connecting rod - The connecting rod transfers the piston motion to the crankshaft. TRX Racing Engines use a "knife-edged" connecting rod. The aerodynamic, sharpened edges allow it to "slice" through the pressurized air/fuel mixture inside the crankcase.

Crankcase - The engine's "body" that contains all of the running mechanical components.

Crankshaft - The main shaft of the engine that holds the reciprocating assembly.

Cooling fins - The cooling fins are milled into the cylinder head and crankcase and cause heat to be drawn away from the engine. Heat is removed when it dissipates into the air passing across the cooling fins. It is important to keep the fins clean of dirt and debris for maximum cooling efficiency.

Cylinder head (head) - The finned aluminum part on top of the engine that is responsible for dissipating most of the engine's heat. The combustion chamber is machined into the bottom of the head.

Dyno - Abbreviation for dynamometer. A precise piece of testing equipment that accurately measures engine power and torque output over the engine's entire RPM range.

EZ-Start - Traxxas on-board electric starting system. The system consists of a hand-held starter control unit and an on-board gearbox with an electric motor to spin the engine.

Filter foam - The oiled foam element inside the air filter housing. The filter foam in the engine must be thoroughly cleaned and re-oiled after every hour of run time.

Fit - Usually refers to the fit of the piston and sleeve. If the fit is tight, the piston will feel very tight at the top of the sleeve (top dead center), and the engine will have good sealing and compression. If the fit is loose, compression will be low and both the piston and sleeve should be replaced.

Flame-out - Occurs when the engine stops running at high RPM. Usually the fault of an excessively lean fuel mixture or glow plug failure.

Fuel - (10%, 20%, 33%) TRX Racing Engines must have model engine fuel to run. Traxxas Top Fuel® Power Plus™ is recommended. Fuel is sold in quarts and gallons from hobby dealers. The 10%, 20% and 33% labeling refers to the percentage of nitromethane contained in the fuel.

Fuel mixture - The ratio of fuel to air as determined by the needle settings of the carburetor.

Fuel tubing (fuel line) - The thick silicone tubing that carries fuel from the fuel tank to the carburetor.

Glow plug - The glow plug is located in the cylinder head at the top of the combustion chamber. It contains an element that glows red hot when voltage is applied. When the engine is being started, the heat from the glow plug ignites the fuel mixture and starts the combustion process.

Glow plug driver - This tool clips onto the glow plug and supplies the required voltage to light the glow plug element. It is also called an igniter. EZ-Start equipped engines do not require this separate tool.

Header - The aluminum tube that connects the exhaust system to the engine exhaust port. The length and diameter of the header must be carefully selected to extract the most power from the engine.

High-speed needle (HSN) - Needle valve that controls the fuel/air mixture at high throttle openings.

Idle speed - The speed (RPM) the engine runs at when the transmitter's throttle trigger is at neutral.

Idle speed adjustment screw - Located on the carburetor body. This screw adjusts the idle RPM of the engine.

Lean - A running condition in which the engine is not getting enough fuel (for the available air). Symptoms include engine overheating, or the engine running for a short time and then stalling, particularly at high speed. This is a dangerous condition that should be corrected immediately to avoid ruining the engine.

Leaning the mixture - Turning either the high-speed and/or low-speed needle(s) clockwise to decrease the amount of fuel the engine receives.

Low-speed needle (LSN) - Needle valve that controls the fuel/air mixture at low throttle openings.

Needle valve - Valve consisting of a tapered needle that closes against a corresponding seat to regulate fuel flow.

Nitro - Abbreviation for nitromethane, a component of model engine fuel that improves fuel combustion and power output. Nitro also refers to a class of R/C powered by model engines instead of electric.

Nitro content - The amount of nitromethane used in the fuel. Usually measured as a percentage of the total fuel volume. Traxxas engines are optimized to use 10-20% nitro. 33% nitro may be used for racing.

Nitromethane - Nitromethane is a component in the fuel that increases power from the combustion process up to a point. Engines are generally optimized to use a range of nitro content for the best power.

O-ring - Rubber "O"-shaped ring used as a sealing gasket.

Pipe - Abbreviation for the tuned exhaust pipe on a nitro engine. See "Tuned Pipe".

Piston - The piston is the internal engine part that is attached to the upper end of the connecting rod and moves up and down in the cylinder sleeve. The precise fit between the piston and the sleeve creates a seal that allows the engine to have the required compression for combustion.

Port - Ports are openings in the sleeve that allow atomized fuel to enter the combustion chamber and burned exhaust gases to exit. The shape and location of the ports are a large factor in controlling the engine timing and power output.

Priming - Manually causing fuel to move from the fuel tank up to the carburetor. This is sometimes necessary after the engine has been sitting for a long period of time and all of the fuel has drained back to the tank. On a Traxxas model this is done by holding your finger over the exhaust tip for one or two seconds while the engine is starting.

Punch - A term that refers to how quickly the model responds to throttle input or how quickly it accelerates.

Rich - A running condition where the engine is getting too much fuel for the available air. It is better to run an engine slightly rich to increase engine life. Excessively rich mixtures cause the engine to have sluggish performance with exaggerated blue smoke and unburned fuel coming from the exhaust.

RPM - Abbreviation for revolutions per minute (how many times the engine crankshaft spins in a minute).

Sleeve - Internal engine part that contains the piston. The precise fit between the sleeve and the piston creates a seal that allows the engine to have the required compression for combustion. The sleeve in a TRX engine is made of brass and is then hard-chrome plated.

Slide carburetor - The throttle on a slide carburetor closes and opens by sliding a barrel in and out of the carburetor body. This type of carburetor is preferred for performance use because it provides a less restrictive "straight-through" air path than the barrel carburetor design.

Stall - When the engine stops running, usually due to an incorrect fuel mixture setting or running out of fuel.

TDC - Top dead center. The top-most position of the engine piston stroke.

Tuned pipe - The tuned exhaust pipe usually consists of a specially-shaped metal or composite chamber with baffles that is designed to enhance the power output of the engine.

Wear-in - Fitment process that occurs during engine break-in, in which internal engine parts develop an even more precise matched fit through actual use under controlled circumstances.

WOT - Abbreviation for wide-open throttle.

THE FUEL

Use the Right Fuel

It's imperative that you use the correct fuel in your TRX Racing Engine for maximum performance and engine life. Traxxas Top Fuel™ should be used to ensure correct engine lubrication, performance, and ease of tuning. Traxxas Top Fuel has been proven in thousands of engines, so you can count on it every day for great performance.

- Top Fuel is the only fuel which is 100% certified for use in Traxxas engines.
- Traxxas Top Fuel is made with just the right balance of the highest grade natural and synthetic lubricants to allow excellent throttle response and the best top-end performance, without sacrificing long-term durability.
- All of the components in the fuel are carefully selected from the best materials available and then custom blended to match the metallurgy and temperature characteristics of Traxxas engines.



You may use 10%, 20% or 33% nitro-content fuel. Try to use the same percentage all the time, avoid switching back and forth between fuels. We recommend that if you break in your engine on 20% fuel that you stick with that percentage. If you do move to a higher or lower percentage, make sure you readjust your fuel mixture to compensate.

Choosing a Nitro Percentage

A commonly asked question is "what is the difference between 10%, 20%, and 33% fuels?" Increasing the nitro in the fuel is almost like adding extra oxygen to the combustion process. It burns more efficiently, improves combustion, and delivers more power. When increased nitro is used, more of the other fuel components are then required inside the combustion chamber to maintain the perfect air/fuel ratio. Therefore, overall fuel mixtures need to be richened slightly (on the high-speed needle, about 3/4 of a turn



DANGER! Model engine fuel is poisonous to humans and animals. Drinking the fuel can cause blindness and death. Handle with care and respect. Keep it out of reach of small children at all times! While driving, do not leave your fuel dispensing bottle on the ground where a child could have access to it. Follow fuel label warnings.

counterclockwise when changing from 20% to 33%, about 1/2 of a turn counterclockwise when changing from 10% to 20%). This allows greater fuel flow through the engine and promotes cooler running, even at the maximum lean settings.

If 33% improves power, then it seems that the highest nitro content available (beyond 33%) should always be used in the engine. In reality, there are practical limitations. Engines are designed to run best within a range of nitro percentages. How the engine is ported, the size of the combustion chamber and other factors determine how much nitro can be efficiently used in the engine. TRX Racing Engines respond exceptionally well to a maximum of 33% nitro, returning cooler temps, more power, and a smoother throttle response. For those who want to run higher nitro, 33% Top Fuel is the optimum nitro percentage for TRX Racing Engines. Increasing the nitro beyond 33% can introduce the need for engine modifications (ports, head shimming, etc.) to avoid starting and tuning difficulties. There are limits to how much nitro an engine can effectively use to make more power. Lower nitro percentages have their own advantages. Nitro is an expensive component in the fuel, so 10% nitro blend is more economical for the sport user. 10% also provides greater latitude with the needle settings for easier tuning.

When using Traxxas Top Fuel, using higher nitro percentages does not cause the engine to wear out faster. 33% Top Fuel contains the same quality lubrication package as 10 and 20% Top Fuel. Some non-Traxxas high-percentage nitro racing fuels do sacrifice some lubrication in attempts to increase performance. We urge you to not take chances with your engine investment and use Top Fuel for consistent performance and long engine life.

Can other brands of fuel be used besides Top Fuel?

There are other fuels that can provide satisfactory performance; however, there could be long-term costs in the form of decreased engine performance, loss of tuning ease, and shorter engine life. Only use fuels that contain both castor and synthetic oil.

Everyone has an opinion or a claim to make about fuel. The engineering team at Traxxas has spent years developing TRX Racing Engines. No one knows more about the specific fuel requirements of Traxxas engines than Traxxas engineers. We strongly urge you not to take chances with your engine investment and use the Traxxas fuel made for TRX Racing Engines.

Handling the Fuel

- **Follow all directions and warnings on the fuel container.**
- Keep the fuel tightly capped at all times. Some components in the fuel can evaporate very quickly and upset the balance of the fuel.
- Do not store unused fuel in the fuel dispenser. Immediately return fresh unused fuel back into the fuel container.
- Do not mix old and new fuel. Never mix different fuel brands together.
- Store the fuel in a cool, dry location, away from any source of heat, ignition, or combustion.
- Read and follow the safety precautions on page 4 in this manual.

 Clean your air filter after every hour of run time to avoid engine damage, even if the filter looks clean.

 If you use compressed air to dry your air filter assembly, wear safety glasses and avoid directing compressed air toward your skin.

 If foam filter oil is not available, clean 30 or 40 weight motor oil can be substituted, but is not preferred. Never run the engine without a properly oiled filter!

THE AIR FILTER

The TRX Racing Engine air filter is specifically designed to deliver maximum performance while protecting your engine from dust and dirt. Use only the supplied filter. **You will not improve engine performance by switching to an aftermarket filter**, and you may risk engine damage due to poor filtration.

The TRX Racing Engine air filter assembly consists of 3 pieces:

1. A rubber filter base
2. A plastic housing consisting of a permanently assembled mesh cap and body
3. An oiled foam element

You must clean the filter after every hour of run time, even if the filter looks clean. This includes the break-in time. Clean your air filter after break-in. Dust (which is often too fine to see) and dirt constantly move through the filter anytime the engine is running. Even if you can't see dirt on the filter, it is present inside the foam after any amount of run time. If you exceed the recommended cleaning intervals, your engine will be damaged. Engine damage or wear due to dirt ingestion is easy to detect, and one of the top causes of premature engine failure.

Air Filter Cleaning Instructions

1. Remove the air filter from the carburetor bore by pulling the entire filter assembly firmly to the side to release it. **Do not pull straight up.**
2. Disassemble the filter. Pull the rubber air filter neck out of the filter body. With the base removed, the foam element is visible in the bottom of the filter body. Pull out the foam element.
3. Clean the filter parts by thoroughly washing all three pieces of the filter assembly in hot, soapy water (dishwashing detergent works well). Repeat twice.

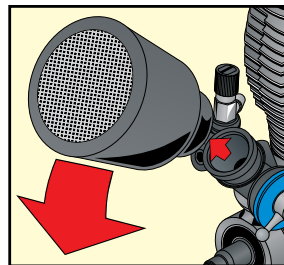

4. Thoroughly dry the parts with a clean towel or compressed air. Remember to wear your safety glasses when working with compressed air.
5. Oil the foam element with foam filter oil. Use the supplied Traxxas filter oil (part #5263) or a high-quality, special-purpose foam filter oil like that used for off-road motorcycle and ATV engines. This type of filter oil is available at motorcycle pro shops. Apply 30 drops of the Traxxas filter oil evenly to the top, bottom, and sides of the filter element (30 total drops divided among the 3 surfaces). Squeeze the filter element repeatedly to help spread the oil throughout. The filter element should be evenly colored by the oil. Even color indicates that the oil is distributed evenly. **Do not** squeeze out excess oil.

Note: Do not use the air filter oil for anything other than the air filter. It is not meant to be a lubricant.

6. Reassemble the filter and install it on the engine, making sure the rubber filter neck fits securely on the carburetor with no gaps or air leaks.

Factory Needle Settings

If your factory preset carburetor adjustments have been tampered with, use the following settings:

- Set the high-speed needle to 4-turns out from closed.
- Set the low-speed needle so the screw head (*red in Fig. A*) is flush (even) with the end of the slide (*yellow in Fig. A*).

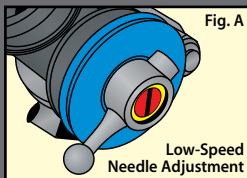

Always use the factory settings for initial starting. Only use these settings when the factory settings have been lost.

THE CARBURETOR

Understanding the carburetor adjustments

The carburetor performs several functions. It controls the engine's speed by restricting the intake of air and fuel into the engine. It atomizes the fuel (suspends the fuel droplets in the air) and also controls the air/fuel ratio of the mixture entering the engine (how much air for a given amount of fuel). To help provide a better understanding of engine tuning and why it's necessary, the following is a brief explanation of the air/fuel combustion process that takes place inside the engine.

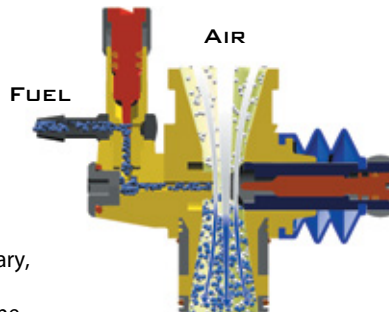

In order to create the cylinder pressure that results in power, the engine burns the air/fuel mixture. Both air and fuel, in correct amounts, are needed for proper combustion. It is the carburetor's job to mix the air and fuel together (atomize the fuel), in the correct proportion for the best possible combustion. This is the ideal air/fuel ratio required for the engine. The ideal air/fuel ratio remains roughly constant. Because of variations in atmospheric conditions (temperature, humidity, altitude, etc.), fuel flow adjustment valves (called fuel mixture needles) are required to meter the fuel and maintain the ideal air/fuel ratio in these ever-changing conditions. For example, colder air is more dense (more air molecules) for a given volume of air and therefore requires more fuel (more fuel molecules) to maintain the correct air/fuel ratio. Warmer air is less dense (fewer air molecules) and therefore needs less fuel to maintain the correct air/fuel ratio. The tuning needles are there to adjust how much fuel is made available for the carburetor to mix with the available air (atomization).

Cold Air (more dense)



Warm Air (less dense)



THE FUEL MIXTURE NEEDLES

The amount of fuel metered and atomized by the carburetor is controlled by the two mixture needles: the high-speed needle and the low-speed needle. The low-speed needle is used to meter the fuel used by the engine at idle and low RPM (part-throttle). The high-speed needle is used to meter the fuel when the throttle is open from part throttle to wide-open throttle (WOT). These two needles provide precise control of the air/fuel ratio across the engine's entire RPM range.

The maximum possible fuel flow is always controlled by the high-speed needle. It works like the main water valve on a garden hose. Turn it clockwise to close the valve, counterclockwise to open it. When the throttle is at idle or partially open, the low-speed needle meters the fuel flow at the outlet (needle seat) where the fuel enters the carburetor venturi. This second valve acts like the spray nozzle at the end of the garden hose in our example. When you accelerate from idle, the throttle opens and the low-speed needle is pulled away from the needle seat. This allows more fuel to flow with the increased air flow. As the throttle is increased, the low-speed needle is pulled completely away from the needle seat, leaving it fully open. At that point, fuel metering is entirely controlled by the high-speed needle. Again, using our water hose example, when the spray nozzle at the end of our garden hose is fully open, then the main water valve can be used to adjust how fast the water flows.

The engine's performance is directly linked to the fuel mixture. Richening the fuel mixture increases the amount of fuel in the air/fuel mixture ratio, and leaning the fuel mixture decreases the amount of fuel in the air/fuel mixture ratio.

- Slightly rich fuel mixtures deliver cooler running and more lubrication but with slightly less power.
- Slightly lean fuel mixtures deliver stronger, more-efficient combustion and more power, but with less lubrication.

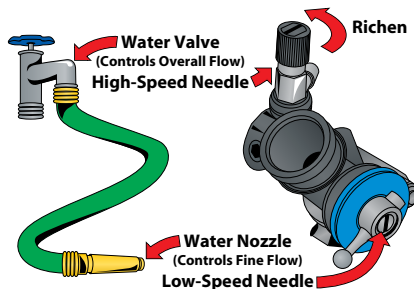

 See *Tuning Your TRX Racing Engine*, starting on page 25, for complete information on adjusting the air/fuel mixture and idle speed.

 A “turn” refers to tightening (“turning in”) or loosening (“turning out”) mixture needles. A “full turn” refers to turning the needle 360°, so a “1/2-turn” would be 180°, a “1/4-turn” would be 90°, and so on.

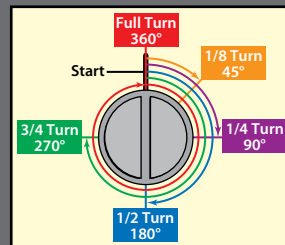

Tuning the engine means finding the perfect balance between the two; excellent power to meet your needs while maintaining good lubrication for long engine life. **The optimal fuel mixture setting is rich** to provide a safety margin against having a lean condition if some variable changes (such as the temperature from one day to the next). General fuel mixture

settings are measured by the number of turns the needles are turned out from fully closed. The fuel mixture settings have been pre-set from the factory to typical break-in settings. Do not readjust your carburetor from the factory settings until after the engine is started and running and you have been able to observe the engine running to assess what minor adjustments may be required to compensate for fuel, temperature, and altitude. Adjustments are usually made in 1/8- or 1/16-turn increments.

The Idle Speed Adjustment

The idle speed adjustment screw controls the closed position of the throttle slide. When the throttle servo is in its neutral position, the throttle slide should be stopped against the idle speed adjustment screw. Always use the idle speed adjustment screw to control engine idle. Do not use the throttle trim on the transmitter to adjust idle speed. The idle speed should be set as low as possible and still maintain reliable running.

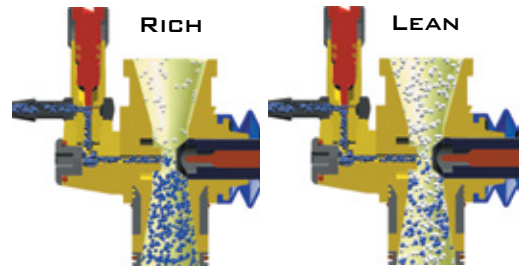

BREAKING IN YOUR TRX RACING ENGINE

TRX Racing Engines use a ringless, aluminum-brass-chrome (ABC) piston/sleeve construction. This type of engine design relies on a very precise running fit between the piston and sleeve for cylinder sealing. **Engine break-in is necessary to allow the piston and sleeve to develop an extremely precise fit and optimum cylinder sealing. Therefore, proper engine break-in is critical to achieving the fastest, most reliable engine performance.**

Allow yourself about 1 to 1½ hours to complete the break-in procedure. The engine break-in period will take 5 tanks of fuel. The break-in time is not the time to impress your friends with your new engine. **You must wait until the engine is fully broken in before attempting sustained high-speed running.** Patience and careful attention during break-in will reward you with the best-performing TRX Racing Engine possible.

During break-in, your engine may appear to malfunction with symptoms like stalling, inconsistent performance, and fouled glow plugs. These are simply the normal “break-in pains” engines sometimes go through. They will disappear once your engine is fully broken in. Many owners report not experiencing any of these symptoms with TRX Racing Engines. **We recommend replacing the glow plug with a new one after the engine break-in procedure.**

Engine Break-in Procedure

The focus during break-in is to vary and limit the engine speed. This will be accomplished by accelerating and stopping at different rates for the first 5 tanks of fuel. As the engine begins to break-in, the duration and intensity of the acceleration will gradually increase. **Sustained high-speed running is not permitted until the 6th tank of fuel.** Perform the initial break-in on a large, flat, paved surface. **Apply all throttle and braking actions gently. Abrupt acceleration or braking could cause the engine to stall unnecessarily.**

 Never run your model indoors. Since model engine exhaust fumes are harmful, always run your model outdoors, in a well-ventilated area.

 Your TRX Racing Engine doesn't usually require priming. If you do need to prime your engine, watch the fuel line carefully to avoid flooding your engine. See page 31 for information on clearing a flooded engine.

 Your carburetor is pre-set at the factory to give the correct air-to-fuel ratio and idle speed for engine break-in. Do not adjust the carburetor unless you observe a poor running condition that requires correction.



See *Safety Precautions* on page 4 for other precautions.

Important points to remember during break-in:

- Special break-in fuels are not recommended. Use the same fuel you plan to use everyday.
- If possible, avoid breaking-in the engine on extremely hot or cold days.
- Pay careful attention to the fuel level. Do not allow the fuel tank to run completely empty. An extremely low fuel level causes the mixture to run too lean. This could result in a burned glow plug or extremely high engine temperatures.
- **Do not** attempt to break in your TRX Racing Engine by idling it on a stand. This will produce poor results.
- Keep extra Traxxas glow plugs handy. The break-in process can cause deposits to form on the plug, leading to plug failure.
- Change or clean your air filter after break-in.
- Follow the instructions exactly for each of the first 5 tanks of fuel.

Starting Your TRX Racing Engine for the First Time

Before you start your TRX Racing Engine for the first time, make sure you have read all instructions and precautions in this manual. **Pay close attention to the tank-by-tank break-in instructions in the next section, and make sure you have read and understood them before you run your engine.**

Your engine must be at room temperature (70°F or 21° C) or above the first time you start it.

If it's cooler than room temperature outside, keep your TRX Racing Engine indoors until you're ready to start it, then take it outside.

1. Turn on the radio system.
2. Make sure the throttle is in the idle position.
3. Pull the starter handle with quick, short, continuous pulls, and watch for fuel moving through the fuel line up to the carburetor. Watch closely! The fuel moves very fast. If the fuel doesn't move through the line within 5 seconds, prime the engine by briefly (one or two seconds) covering the exhaust outlet until the fuel is just visible in the carburetor fuel line. **Watch carefully! If the engine is primed too long, it will flood with fuel and stop turning.**

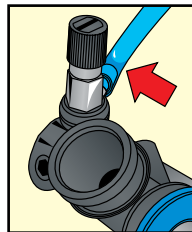

5. Once fuel reaches the carburetor, the engine should quickly start and idle.
6. Proceed with the engine break-in.

If your engine doesn't start, refer to the TRX Racing Engine troubleshooting section at Traxxas.com/support. If your factory fuel mixture settings have been altered, refer to page 16. If you still have problems, contact Traxxas Customer Support at 1-888-TRAXXAS or support@traxxas.com.

Tank 1

1. Drive the model with the **body off**.
2. Driving procedure: **Gently pull the throttle trigger to about 1/4 throttle over a 2-second count. Then, gently apply the brake to stop.** Count the two seconds out while accelerating: one thousand one, one thousand two, and then stop. Operate the throttle trigger as smoothly as you can. **Repeat this starting and stopping procedure until the first tank of fuel is nearly empty.**
3. Look for thick blue smoke exiting the exhaust outlet. If there is no smoke, richen the high-speed needle 1/4-turn by turning the needle counterclockwise.
4. When the fuel tank is nearly empty, shut off the engine by pinching the fuel line connected to the carburetor (use the clamp if installed on your model).
5. Let the engine cool for 15 minutes.

Note: If at any point the engine cuts out or stalls during gentle acceleration, richen the high-speed needle 1/4-turn by turning the needle counterclockwise.

Tank 2

1. From tank 2 forward, model should be driven **with the body on**.
2. Driving procedure: **Gently pull the throttle trigger to about 1/2 throttle over a 2-second count. Then, gently apply the brake to stop.** Count the two seconds out while accelerating: one thousand one, one thousand two, and then stop. **Repeat this starting and stopping procedure until the second tank of fuel is nearly empty.**
3. When the fuel tank is nearly empty, shut off the engine and let it cool for 15 minutes.



As you gain experience in the hobby, you may discover that many people have differing opinions on what is the proper procedure to break-in a model engine. *Only use the Traxxas break-in procedure. Other break-in procedures could result in a weak, damaged, or otherwise poor performing engine.* The procedure outlined here was extensively tested and proven to yield better performing engines than other "common" break-in methods. Even if you have years of experience using model engines, please do not ignore this caution!

Tank 3

1. Driving procedure: **Gently pull the throttle trigger to 1/2 throttle over a 3-second count. Then, gently apply the brake to stop.** Count the three seconds out while accelerating: one thousand one, one thousand two, one thousand three, and then stop. **Repeat this starting and stopping procedure until the third tank of fuel is nearly empty.**
2. As the engine loosens, the idle speed may increase and cause the model to try to creep forward when stopped. Reduce the idle speed by turning the idle speed adjustment screw (see page 6) on the carburetor counterclockwise.
3. When the fuel tank is nearly empty, shut off the engine and refuel. From here on, you do not need to let the engine cool between tanks.

 Tank 4

1. Driving procedure: **Gently pull the throttle trigger to full throttle over a 3-second count. Then, gently apply the brake to stop.** Count the three seconds out while accelerating: one thousand one, one thousand two, one thousand three, and then stop. **Repeat this starting and stopping procedure until the fourth tank of fuel is nearly empty.**
2. Apply the throttle gradually! Your finger should not reach full throttle until the end of the three-second count.
3. Keep your driving smooth and consistent.
4. When the fuel tank is nearly empty, shut off the engine and refuel.

 Tank 5

1. Driving procedure: **Gently pull the throttle trigger to full throttle over a 3-second count, hold for 2 more seconds, and then gently apply the brake to stop.** Count the five seconds out while accelerating. **Repeat this starting and stopping procedure until the fifth tank of fuel is nearly empty.**
2. The model should now be shifting into second gear. If it is not, try turning the high-speed needle clockwise 1/8-turn to lean the fuel mixture slightly and test for shifting.
3. When the fuel tank is nearly empty, shut off the engine and refuel.

Tank 6

STOP! Clean your air filter before you proceed. Refer to the instructions on page 14. During the sixth tank of fuel, the engine can be tuned for general performance use. Proceed to the next section in this manual for instruction on tuning the engine.

TANK	THROTTLE	TIME	COOL	BODY	NOTES
1	1/4	2 Seconds	15 Minutes	Off	Apply throttle gradually.
2	1/2	2 Seconds	15 Minutes	On	Apply throttle gradually.
3	1/2	3 Seconds	-	On	Reduce idle speed if necessary.
4	Full	3 Seconds	-	On	Gradually accelerate over 3-second count.
5	Full	5 Seconds	-	On	Accelerate over 3-second count, hold for 2 seconds.

Winter Break-in Tips

During the break-in process, the piston and sleeve wear into each other to form a precise fit. The engine needs to heat up to a temperature of at least 200°F to 215°F to allow the piston and sleeve to achieve this fit properly. A precise fit between these two components is critical for proper compression and optimum performance. If the engine runs too cold during break-in, the piston and sleeve will not expand to their appropriate sizes for break-in. This can lead to premature wear of these components. This wear may not become apparent until winter has passed and the engine is operated under warmer running conditions.

- Warm the engine to approximately room temperature by removing all fuel and storing the vehicle inside at room temperature until just before starting the engine. An extremely cold engine can become difficult to start.
- After the engine is running, it is important to keep the temperature of the engine to at least 200°F to 215°F during break-in. In weather below 45°F, your TRX Racing Engine will tend to run at lower temperatures between 160°F to 180°F (when tuned at proper break-in mixture settings). This is too cool for break-in. **Do not lean the engine to increase engine temperature!** This will also decrease lubrication and cause your piston/sleeve to wear prematurely.



High Altitude Operation:

If you live in a high altitude region (5000 or more feet above sea level), the lower air density may require you to lean your high-speed fuel mixture slightly from the factory break-in settings. Try this if you are experiencing difficult starting or extremely sluggish engine performance at high altitude.

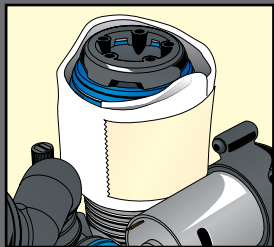

- Wrap the cooling head with a paper towel, clean rag, or sock to help keep the engine running at the recommended 200°F to 215°F break-in temp. If too much heat is contained, the engine may run too hot. Make sure that you monitor the engine's temp closely for the first couple of tanks until you get the right amount of cover for the cooling head. This will, of course, depend on your current weather conditions. Adjusting the cover up and down, exposing more or fewer cooling fins, is a convenient way to regulate engine temps.
- For owners that do not have access to a temperature probe, a drop of water on the cooling head (around the glow plug area) should slowly sizzle for approximately 6 to 8 seconds when the engine temp is 200°F to 210°F. If the water sizzles for only a few seconds, then it is likely that the engine temp is over 220°F and needs to cool down. If the water takes a long time or does not evaporate at all, then the engine is too cool.
- We do not recommend that you operate your engine below 35°F. If you insist on running your vehicle below 35°F, be aware that nitro engines may be very difficult to start and tune at those extremely cold temperatures. Also, at temperatures below freezing, nitro fuel can actually begin to gel up, which can be harmful to the engine.
- Follow the remaining break-in procedures as outlined in this owner's manual. This, along with the steps listed above, will ensure a good break-in for your new nitro engine and provide many hours of enjoyment.

TUNING YOUR TRX RACING ENGINE

The engine's performance depends on the fuel mixture. Turn the mixture needles clockwise to lean the fuel mixture and counterclockwise to richen it. Leaning the fuel mixture will increase engine power up to the engine's mechanical limits. **Never run the engine too lean (not enough fuel flow). Never lean the engine until it begins to cut-out or stall.** Leaning the engine beyond the safe allowable limits will result in poor performance and almost certain engine damage. Indications of an overly lean mixture include:

- **Cutting out or sudden loss of power during acceleration.**
- Overheating (temperature beyond 270°F at the glow plug)
- Little or no blue smoke coming from the exhaust.

If any of these conditions are present, stop immediately and richen the high-speed mixture 1/4-turn. The engine will probably be slightly rich at that setting and you can then retune for performance. Always tune for performance by starting rich and moving leaner toward the ideal setting. **Never try to tune from the lean side. There should always be a light stream of blue smoke coming from the exhaust.** Before you begin tuning, the engine should be warmed up to its normal operating temperature and running slightly rich. All final tuning adjustments must be made to the engine at its normal operating temperature. You can tell the engine is running rich by noting any of the following:

- Sluggish acceleration, with blue smoke coming from the exhaust
- Unburned fuel spraying from the exhaust tip
- Leaning the high-speed fuel mixture increases performance

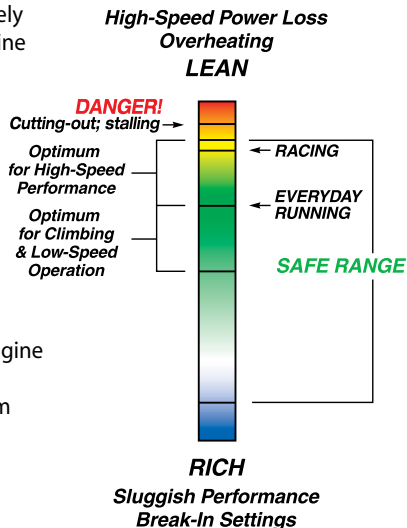

! When tuning for performance, watch closely to notice when there is no longer any increase in speed or power when the high-speed mixture is lean. If you lean the high-speed mixture to the point that the engine cuts-out, hesitates, or stalls, you are well into the danger zone and engine damage is likely. Richen the high-speed needle 1/4-turn and retune.

! Higher nitro requires a richer fuel mixture. When running 33% fuel, richen your high-speed needle 3/4-turn if previously running 20% nitro and then re-tune the engine for maximum performance.



For your convenience, the low-speed needle has a positive stop that prevents it from being over-tightened and damaging the needle and seat. This also provides an easy way to gauge how many turns out from closed the low-speed needle adjustment is set to.



When adjusting the low-speed fuel mixture, it is very important to make several high-speed runs with your model between adjustments to clear out any excess fuel. Perform the pinch test immediately after. If the engine is allowed to idle for a long period of time, it could "load up" with fuel and give you an inaccurate measurement from your pinch test.

High-Speed Fuel Mixture Adjustment

With the engine warm and running at a rich setting, gradually lean the high-speed fuel mixture in 1/16-turn increments. Make several high-speed passes after each adjustment to clear out the engine and note any change in performance. TRX Racing Engines are extremely powerful. Remember to apply the throttle gradually to prevent wheelies or loss of control. Continue this procedure until there is no longer any performance improvement. **If any one of the following conditions occurs, the fuel mixture is already past the maximum safe lean setting:**

1. There is no longer any performance improvement.
2. The engine begins to cut out at high speed (**Danger!**).
3. There is a sudden loss of power during acceleration (**Danger!**).
4. The engine begins to overheat. Symptoms of overheating include:
 - Fluctuating idle speed
 - Hesitation or stalling during acceleration
 - Steam or smoke coming from the engine (not exhaust)
 - Popping or clattering sound when decelerating (detonation)
 - Temperature measurement above 270°F at the glow plug (A temperature reading above 270°F alone does not necessarily indicate overheating. Look for other symptoms of overheating combined with temperature for a more accurate warning.)

If any of the above conditions occur, richen the fuel mixture to the optimum setting by richening the high-speed needle at least 1/8-turn counterclockwise and retest. This setting will extend engine component life.

Low-Speed Fuel Mixture Adjustment

The low-speed mixture is always set after the high-speed needle is correctly adjusted. Set the low-speed mixture using the following pinch test.

1. Once the engine is warm, do several high-speed runs to confirm that the high-speed needle is set correctly.
2. Bring the vehicle in and pinch closed the fuel line going into the carburetor. The engine should run for 2-3 seconds, speed up, and then die.

3. If the engine runs longer than 3 seconds, then lean the low-speed needle 1/16-turn, make several more high-speed runs, and retest.
4. If the engine dies immediately without speeding up, then richen the low-speed needle 1/8-turn, make several more high-speed runs, and retest.

When the low-speed needle is set correctly, the engine's throttle response should be very quick.

Idle Speed Adjustment

Once the high- and low-speed mixtures have been set, reduce the idle speed to the minimum reliable idle speed. Remember, this adjustment should be made while the engine is running at normal operating temperature.

1. Make sure that the throttle slide is stopped against the idle speed adjustment screw by releasing the throttle trigger to neutral or adjusting the throttle trim on the transmitter (depending on model) so that the brakes are applied. **Note:** Remove the air filter to gain access to the idle speed adjustment screw, if necessary.
2. Turn the screw counterclockwise to reduce the idle speed or clockwise to increase it. The idle speed should be set as low as possible while still maintaining reliable running characteristics.
3. If equipped, reset the throttle trim on the transmitter to its original position.

Fine-Tuning the Carburetor

After fine-tuning your TRX Racing Engine at the end of the break-in procedure, no major adjustments to the fuel mixture are usually necessary. Make note of the temperature, humidity, and barometric pressure at the time you finished fine tuning your carburetor. Current weather conditions can be found online from national websites, local TV news websites, and television. This information will be considered your baseline setting. You may need to adjust your carburetor needles to compensate for changes in temperature and barometric pressure (air density) from day to day. Generally, you'll need to richen the fuel mixture when the weather is colder than your baseline temperature and the air density is higher. Lean the fuel mixture when weather is warmer than your baseline temperature and the air density is lower. The chart below provides general guidelines on how weather conditions affect air density when they move higher or lower than your baseline setting (see page 16 for detailed info on how air density affects mixture settings).

IF THE...	IS...	THEN THE AIR DENSITY IS...	ADJUST (CORRECT) THE FUEL MIXTURE TO BE...
Humidity	Lower	Slightly more dense	Slightly richer
	Higher	Slightly less dense	Slightly leaner
Pressure (barometer)	Lower	Less dense	Leaner
	Higher	More dense	Richer
Temperature	Lower	More dense	Richer
	Higher	Less dense	Leaner
Altitude	Lower	More dense	Richer
	Higher	Less dense	Leaner
Nitro %	Lower		Leaner
	Higher		Richer

Tuning the Engine by Temperature

The following procedures require an optional infrared temperature probe or on-board temperature gauge (Traxxas on-board digital temperature gauge, part #4091). Engine temperature can be used as an effective tuning aid when you understand the relationship between engine temperature and ambient temperature. The engine operating temperature, when tuned for maximum performance, will vary according to atmospheric conditions, engine load, gauge accuracy, and many other factors. The atmospheric condition that has the most influence on engine temperature is air temperature. Expect the engine temperature to vary almost in direct proportion to air temperature. Assuming you tuned the engine for the same maximum performance each day, the engine will run about 20° hotter when it's 90°F outside than it would in 70°F weather. For this reason, we cannot give you a definitive temperature range that indicates the best possible engine tuning.



The temperature gauge can aid you in tuning by giving you a relative indication of how your adjustments are affecting the engine and to help prevent you from reaching excessive engine temperatures. For example, as you lean the fuel mixture, the engine performance will increase along with the temperature. If you continue to lean the fuel mixture and the temperature increases but the engine performance does not change, then you have exceeded the maximum safe lean setting. Make note of

the engine temperature. Generally, try to keep your engine from exceeding 270°F when measured at the glow plug. If necessary, increase airflow to the engine by cutting out the rear of the body, windshield, and front valance. In some situations, the engine may perform very well with no stalling, lagging, or hesitation at temperatures above 270°F, particularly in very hot climates. If richening the fuel mixture to bring the temperature down to 270°F results in poor, sluggish performance (engine never cleans out), then return the engine back to a satisfactory state of tune based on how it sounds and performs (always with a visible stream of blue smoke coming from the exhaust). If engine temperature is exceeding 270°F with proper cooling and no signs of abnormal running, then avoid running the engine at its maximum lean setting. Watch closely for **any** signs of overheating. Richen the fuel mixture slightly to provide a safety margin of additional cooling lubrication. Symptoms of overheating include:

- Steam or smoke coming from the engine (not exhaust)
- Hesitation or stalling during acceleration
- Popping or clattering sound when decelerating (detonation)
- Fluctuating idle speed

There is NO optimal temperature that can be used as a target to deliver the best engine tuning. Do not rely on a temp gauge alone to tune your engine. Tune the engine by paying very close attention to how it responds to changes in fuel mixture (more smoke/less smoke, fast/sluggish, reliable/stalling, smooth sound/ muffled sound, etc). Once the engine is tuned, then observe the temperature.

TROUBLESHOOTING YOUR TRX RACING ENGINE

The following section addresses some very basic engine and radio questions you may have about your TRX Racing Engine. Most questions arise from simple user errors or minor adjustments that are easy to correct. If you can't find a solution for your TRX Racing Engine here, visit our web site at Traxxas.com and click on the Customer Support menu. There you will find a much more extensive and detailed online troubleshooting area. In addition, you may call Traxxas Customer Service at 1-888-TRAXXAS (outside the U.S., call +1-972-265-8000).

Engine spins but will not start:

- If you're using a glow plug igniter, make sure it's fully charged and connecting properly to the glow plug. If the igniter is fully charged, then replace the glow plug. It is normal for glow plugs to require periodic replacement. Only use Traxxas heavy-duty long glow plugs.
- Check to make sure the fuel is getting to the carburetor. Remove the fuel line where it connects to the carburetor to see if there is fuel in it. If not, you may need to prime the engine. Reconnect the fuel line and then refer to page 20 for instructions on priming the engine.
- Check your fuel mixture settings. It may be necessary to adjust the fuel mixture if the outside temperature or barometric pressure has changed significantly since the last time the engine was run (see Fine-Tuning the Carburetor on page 27). Turn the high-speed needle out (rich/ counterclockwise) 1/4-turn, hold the throttle trigger at about 1/2 throttle, and try again to start the engine. Once started, retune the engine for performance (see page 25).
- The engine could be worn. If the fit between the piston and sleeve is loose, compression is reduced and the engine will be difficult to start when it is warm, and may tend to stall when running and when the throttle is closed suddenly to idle. Engine life depends on many factors, including fuel type, air filter maintenance, needle settings, and how the engine was used. For example, if the engine was allowed to ingest dirt from lack of air filter maintenance or running through water, then the internal engine components could wear out extremely fast.
- Glow plug may have failed. If using an EZ-Start, check to see if the glow plug light is on when starting. If not, replace the glow plug. If using a glow ignitor, remove and check the glow plug.

Engine performance sluggish:

- Engine performance depends mostly on the fuel mixture settings and how they compensate for the current atmospheric conditions. Before you suspect other failures with the engine, richen the high-speed needle at least 1/4-turn and then retune the engine for performance (see page 25).
- Try a new Traxxas glow plug. Sometimes a glow plug will work well enough to start the engine but not be able to deliver the engine's full performance potential.
- If the fuel mixture seems to be set correctly, make sure the fuel is fresh. If the fuel is old, or was left uncapped for a long period, then some of the important fuel components could have evaporated. Try new, fresh, Traxxas Top Fuel.
- Check to make sure there is no binding in the driveline that would cause excessive loads on the engine.

Engine will not spin (pull start or electric starter will not turn the engine):

- The engine could be flooded. If too much fuel accumulates in the combustion chamber at start up, the engine will hydraulically lock. Follow the procedure on page 31 for clearing a flooded engine.
- Check for binding at the engine flywheel. If you are not able to turn the engine by hand, the engine could be flooded, there could be binding in the clutch system, or there could be internal engine damage. See page 31-32 for info on clearing a flooded engine and releasing a stuck piston. (**Note:** It is normal for the engine to be extremely tight and hard to turn when the piston reaches the top of the compression stroke.)
- Piston stuck at top dead center, see page 32 for info on unsticking the piston.

Engine extremely sluggish, hard to start, and will not idle during tank 1 of the break-in:

- It is possible that the factory adjusted break-in settings on your carburetor are too rich for your geographic location, atmospheric conditions, or fuel brand. Extremes in temperature, humidity, barometric pressure, and altitude can't always be accounted for with a single high-speed needle setting. The symptoms described above can occur when the air density is very low, such as in high

mountainous elevations and extremely cold temperatures. Under these conditions, lean the fuel mixture slightly, 1/8-turn, and see if there is any improvement in starting and idling. Lean the fuel mixture only until the engine will run and idle reliably, and then proceed with the break-in.

- The contents of different brands of fuel (other than Traxxas Top Fuel) in combination with extreme atmospheric conditions can also make the factory preset break-in settings too rich and cause the symptoms described above. Again, try leaning the fuel mixture slightly, 1/8-turn, to see if there is any improvement in starting and idling.

Clearing a Flooded Engine:

If the engine is primed for too long during startup, it can become flooded with fuel. When the engine is flooded it will no longer turn due to excess fuel in the combustion chamber, preventing upward movement of the piston. Use the following procedure to clear a flooded engine:

1. Remove the glow plug and gasket with the glow plug wrench supplied with your model.
A 5/16" (8mm) nut driver will also work.
2. Turn the model upside down.
3. Pull the starter handle several times to clear the engine of excess fuel.
4. Turn the model over and reinstall the glow plug and gasket.
5. Do not prime the engine. Apply 1/2 throttle and pull the starter. The engine should start immediately.

Piston stuck at "top dead center" (TDC)

"Top dead center" is the position where the piston is at the very top of the tapered sleeve. Occasionally an engine can get "stuck" at this position. This is most likely to happen on new engines during break-in, but can also happen at other times. If the engine is stuck at TDC, use the following procedure to release the piston from the sleeve:

1. Remove the glow plug using a 5/16" (8mm) nut driver and verify that the piston is at the top of its stroke.
2. Locate the flywheel at the front of the engine; it looks like a silver 50-cent piece with serrated edges. Part of the flywheel is obscured beneath the carburetor, but part of it is accessible from the top side. This is the part of the flywheel where the procedure is performed.
3. Use a flat-blade screwdriver to rotate the flywheel. Place the blade of the driver into one of the grooves of the flywheel and push down, turning the flywheel counterclockwise when viewed from the front. You should see the flywheel turn and the piston should become unstuck from the sleeve. [**T-Maxx and Revo:** Place the blade of the driver through the opening of the chassis beneath the flywheel. Place the edge of the blade into one of the grooves of the flywheel and rotate counterclockwise (when viewed from the front), using the chassis for leverage.]
4. Put two or three drops of light machine oil into the glow plug hole to lubricate the piston and sleeve. Do not use too much oil. It will hydro-lock the engine. Verify the starter will spin the engine with the glow plug out.
5. Rotate the flywheel so the piston is at bottom dead center and replace the glow plug with gasket.
6. You should now be able to start the engine.

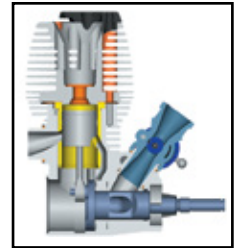

Top Dead Center

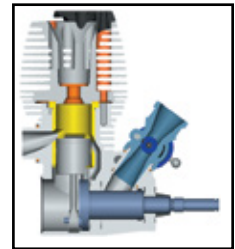
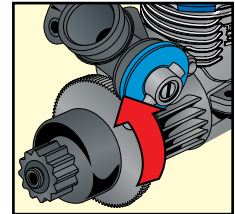

Bottom Dead Center

MAINTAINING AND STORING YOUR TRX RACING ENGINE

Your TRX Racing Engine requires timely maintenance in order to stay in top running condition.

Neglecting maintenance could allow dirt, deposits, and moisture to build up inside the engine, leading to internal engine failure. Follow proper maintenance and storage procedures to avoid damage to your engine. The following procedures should be taken very seriously.

After each hour of running:

- Clean and re-oil the air filter. The instructions for this procedure are on page 14. **We cannot stress enough the value of cleaning your air filter at the scheduled intervals.** The cleanliness and condition of your air filter directly influences the running life span of your engine. **Do not skip air filter maintenance!**
- Clean the outside of the engine of accumulated dirt, oil, and grime. Accumulated grime will decrease the engine's ability to cool itself.

After each running session:

- Perform after-run maintenance on the engine. This clears the engine of destructive moisture and other corrosive deposits. **This is extremely important for the life of the engine. See page 34 for after-run maintenance procedures.**
- Inspect the vehicle for obvious damage or wear. Look for:
 1. Loose or missing screws
 2. Cracked, bent, or damaged parts
 3. Cut or loose wiring
 4. Cut or kinked fuel lines
 5. Signs of fuel leakage
- Inspect the gears for wear, broken teeth, or debris lodged between the teeth.



If the engine is worn or damaged enough to require replacing the piston, sleeve, or connecting rod, consider exchanging your old engine for a brand new engine under the terms of the Traxxas Power Up Program. It could save you time and effort. Details are in your documentation package or at Traxxas.com/powerup.



Don't put the fuel from your tank back into your fuel jug. Dispose of it properly, following city or county regulations.



Always wear eye protection when using compressed air or spray cleaners and lubricants.



Denatured alcohol (available from home centers and paint supply stores) in a spray bottle is an extremely effective cleaner. Be sure to wear safety glasses and gloves when working with denatured alcohol. Follow all precautions on the product labeling.

After-run Procedure

You must perform after-run maintenance on your Traxxas engine whenever the model will be stored for longer than a few hours. Taking the time to prepare your engine for storage will reward you with longer engine life, easier starting, and better performance.

When a nitro engine is shut off, some excess unburned fuel remains in the engine. The methanol in model engine fuel is hygroscopic, which means it easily attracts and absorbs moisture. This moisture can cause rust and corrosion on the steel engine parts (crankshaft, bearings, wrist pin, and starter shaft) if the fuel is not removed from the engine. There are after-run oil products available from your hobby dealer or you can use WD-40™, a common household lubricant. To ensure your TRX Racing Engine is protected from internal corrosion, use the following procedure:

1. Shut off the engine by pinching the fuel line closed. This allows most of the excess fuel to be consumed by the engine. Be sure the throttle is in the idle position. You may have to pinch the fuel line closed for several seconds before the engine stops.
2. Completely empty the fuel tank. Use your fuel-dispensing bottle to suck out the old fuel. Do not mix the old fuel with your fresh fuel supply. If you leave fuel in the tank, transporting or handling your model may cause fuel to run into the engine.
3. With the fuel tank empty and the throttle at the idle position, try to start the engine. The engine will most likely start and run for a few seconds as it uses up any fuel remaining in the engine and fuel lines.
4. Once the engine stops, clean the outside of the engine with compressed air or spray motor cleaner. Once the engine is clean and dry, remove the (blue) glow plug power wire, glow plug, and air filter.
5. Open the throttle fully and spray a one-second burst of WD-40™ into the carburetor and into the glow plug hole (CAUTION! Wear safety glasses to prevent spray from getting into your eyes).
6. Place a rag or paper towel over the engine to catch any WD-40™ that may come out of the carburetor or glow plug hole.

7. Crank the engine with the EZ-Start™ (or pull the starter handle) continuously for about 10 seconds.
8. Remove the rag or paper towel and repeat steps 5–7 two more times.
9. Clean and re-oil the air filter so it will be ready for use next time. See page 14 for air filter maintenance instructions.
10. Replace the glow plug and reinstall the air filter.

Other periodic maintenance:

- **Piston/sleeve:** The life of the piston and sleeve will vary greatly with how the engine was used and maintained. The piston and sleeve should be replaced when they no longer seal effectively (loss of compression). Symptoms include the engine being difficult to start when warm, stalling when warm, and stalling when throttle is suddenly closed to idle. Replace the wrist pin and G-clip whenever the piston and sleeve are replaced. Follow the instructions for the proper break-in procedure of a new TRX Racing Engine whenever the piston and sleeve are replaced.
- **Connecting rod:** The connecting rod should be replaced when the piston and sleeve are replaced or after three gallons of fuel, whichever comes first. Also replace the piston wrist pin and G-clip whenever the connecting rod is replaced. As with other internal engine components, the connecting rod's life depends on the engine's usage and the quality and frequency of the engine's maintenance.



Do not store your model indoors with fuel remaining in the tank or the engine.



TRX engines are designed to be easily rebuilt. Critical engine components such as the crankcase, crankshaft, and engine bearings are made to extremely high quality standards and should under normal circumstances outlast multiple sets of pistons, sleeves, connecting rods, and wrist pins (reciprocating assemblies). It could be more economical for you to continue to use your good bearings and crankshafts, and simply replace the reciprocating assembly as needed. Engine assembly is not difficult and replacing the reciprocating assembly does not require any special tools or skills.

101



These instructions are for the rebuilding of the TRX Racing Engine once the engine has been removed from the chassis. *(These instructions were performed on a TRX 3.3 engine equipped with the EZ-Start electric starting system and Revo exhaust system. Other TRX Racing Engines and engines equipped with pull starters or backplates [without starter] are similar.)*

102



It is very important to clean the exterior of the engine and EZ-Start system thoroughly before disassembly. These instructions show you how to replace the entire internal reciprocating assembly.

The following instructions are for engines equipped with IPS crankshafts using Traxxas clutch components. For Multi-shaft™ crankshafts in non-Traxxas applications, follow the manufacturer's directions for clutch installation/removal.

103



1. Remove the exhaust pipe and header from the engine by removing the two 3x15CS screws (102 & 103).

104



If your engine is equipped with a starterless backplate, proceed to step 2. Remove the three 3x12BCS screws that secure the EZ-Start (or pull start) assembly to the engine and separate the drive unit from the engine (104). Be sure to remove the 6x8x0.5 PTFE-coated washer that is installed on the starter shaft between the one-way bearing and the engine.

201



2. Remove the 5.0mm E-clip from the crankshaft (Nitro 4-Tec owners will need to remove the 3x10CS screw) and slide the 5x8x0.5PTW with the clutch bell off of the crankshaft (Nitro 4-Tec owners will need to slide two 5x8x0.5PTW off the pilot shaft.) **CAUTION: It's important to use eye protection when removing the E-clip from the shaft to prevent the clip from causing an injury.** Pull the clutch shoes off of the flywheel pins.

202



Remove the flywheel nut from the crankshaft using an 8mm socket (202) and disconnect the flywheel from the crankshaft by lightly tapping the back of the flywheel with a rubber or plastic mallet.

203



Place a small flat-blade screwdriver into the slot of the split cone washer and twist slightly to loosen the split cone from the crankshaft (203). Slide the split cone washer off of the crankshaft. The engine is now ready to be rebuilt (204).

204





3. Remove the glow plug from the cooling head and discard the plug. The glow plug should be replaced with a new one anytime the engine is rebuilt.

Remove the four 3x6CS (3x6BCS on engines equipped with non-starter backplate) screws from the backplate of the engine and pull the backplate from the crankcase (301).



Remove the head protector (requires removal of five 3x8CCS on the TRX 3.3). Remove the cooling head from the engine case by removing the five 3x12CS head bolts (302). Be careful not to lose or damage the copper head gasket. If the head gasket is damaged, replace it with a new one.



4. Locate the bottom of the sleeve through the rear opening of the crankcase. Press the bottom of the sleeve upward with a plastic or wooden stick (401), this is to prevent internal damage to the crankcase. The sleeve should slide up and out of the crankcase (402).



Rotate the crank to where the connecting rod and piston are located at TDC (403).

Gently pull on the bottom of the connecting rod with needle-nose pliers, sliding the rod off of the crank pin (403). Be careful not to damage the connecting rod if it is being reused.



The rod and piston assembly will exit the top of the crankcase (404).

5. Push the end of the pilot shaft through the crankcase. The crankshaft should exit the rear of the crankcase (501). Loosen the 3.0NL just below the base of the carburetor (502). Slide the carburetor up and out of the crankcase (503). Now the crankcase is ready to be flushed clean and inspected.



601

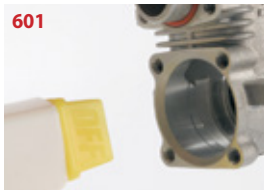

6. Flush the crankcase and bearings out with out with denatured alcohol or electric motor spray. Dry the crankcase with compressed air (601). **CAUTION: Do not let the compressed air spin the bearings, and always use eye protection when using compressed air.**

Inspect the crankcase and bearings for damage or missing parts. Make sure that the bearing cages are not broken and check for corrosion inside of the crankcase. The bearings should feel smooth and have little play. Make sure the bearings spin freely and that there are no particles or grit in them. Replace the bearings if there are any signs of damage. Inspect the exhaust O-ring gasket and the backplate O-ring gasket for tears (602). Replace these O-rings if needed.

701



7. Apply a few drops of machine oil or after-run oil to the bearings. Inspect the crankshaft for corrosion and also check for scratches or score marks around the intake port of the crankshaft (see arrow). Check the crank pin for wear (701). The connecting rod should fit and rotate smoothly on the crank with no play between the rod and the crank pin. If there is play between a NEW connecting rod and the crank pin then the crank pin is worn and the crankshaft will need to be replaced.

801



Important: Do not reuse a damaged or worn crankshaft. This will dramatically shorten the life of your rebuilt engine. If there are damaged or worn parts beyond the piston, sleeve, and connecting rod, it may be best to take advantage of the Traxxas Engine Replacement Program (ERP).

802



8. Use after-run oil to lubricate the bearing surfaces of the crankshaft before assembling it into the crankcase. Slide the crankshaft back through the crank bearings until it stops. Inspect the carburetor O-rings for damage and the rubber throttle arm boot for tears (801 & 802).

Unscrew the high-speed needle all the way out of the needle housing (803) and flush out the high-speed needle housing and the carburetor body with denatured alcohol or electric motor spray. Use compressed air to dry the components. **Remember:** Always wear safety glasses when using compressed air to prevent injury. Reinstall the high-speed needle into the needle housing and return the mixture setting back to the factory recommended break-in setting (4-turns out from fully closed).

803



804



Carefully insert the carburetor into the crankcase until fully seated. While pressing the carburetor firmly into the crankcase, tighten the pinch bolt (804). This process ensures that the upper O-ring forms a good seal between the carburetor and the crankcase.

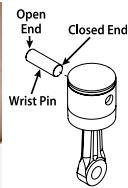

9. Apply a drop of after-run oil in the piston's wrist pin bore, before installing the wrist pin. Locate the oil hole (refer to pic 901) in the connecting rod and the skirt relief side of the new piston.

Insert the connecting rod into the piston with the piston skirt relief and the oil hole on the same side (901). Line up the wrist pin bore in the rod with the wrist pin bore in the piston and slide the wrist pin through the larger opening in the piston. Note that the closed end of the wrist pin should be inserted first into the opening. The orientation of the wrist pin helps keep the wrist pin cool.



Install the wrist pin clip into the groove of the piston's wrist pin bore (902). This will retain the wrist pin inside of the piston. **CAUTION: Do not allow the pliers to scratch the piston, and make sure that the clip expands into the groove.**



Lower the piston and connecting rod assembly into the top of the engine case with the oil hole of the connecting rod facing toward the crankshaft. Apply a drop of oil onto the crank pin before installing the connecting rod onto the crank pin. Slide the connecting rod over the crank pin and rotate the crank pin to the bottom center of the crankcase (903).



10. Lube the outside of the piston with after-run oil and make sure the crank is at BDC, then slowly lower the sleeve until it is just above the piston. Rotate the crank slowly to bring the piston into the sleeve. If there is any resistance, stop! Repeat until the piston moves smoothly into the sleeve. Bring the piston close to TDC, then push the sleeve in fully. **Important:** The slot (in the lip) at the back of the sleeve must key into the pin at the back of the crankcase opening (1001). **Do not** install the cooling head until these two items are keyed into each other.

Place the stock copper head gasket onto the sleeve and fit the cooling head into the sleeve. Note that there are two slots notched through the cooling fins on each side of the cylinder head. These slots are for access to the engine mounting top of the engine case and the access slots on the cooling head should line up with the slots manufactured into the crankcase (see picture 1002 for orientation). Be careful not to damage the copper head gasket.

While pressing the head squarely onto the sleeve, thread the head bolts into the engine case just until they stop. **Do not** tighten down these bolts individually. It is very important to attain even pressure around the cooling head. Slowly tighten each screw, just a little at a time, in a crossing pattern (see picture 1003) until each bolt becomes snug. Tighten each bolt in the same pattern to 9-11 in·lbs. of torque.

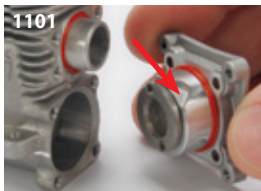

11. Inspect the backplate bushing and starter shaft for wear and clean them with denatured alcohol. Fasten the backplate with the starter shaft to the crankcase. **Important:** The reliefs that are manufactured into the backplate must line up to match the ports inside of the engine case (see picture 1101 for orientation).



Key the starter shaft to the crank pin by slowly rotating the starter shaft as pressure is applied towards the crankshaft. Once the starter shaft is keyed into the crank pin, join the backplate to the engine case and secure the assembly with the four 3x6CS screws (1102). (On non-starter models, simply align the reliefs in the backplate and fasten it to the crankcase with (4) 3x6BCS screws).



Install a new glow plug (Traxxas #3232 is recommended for your TRX Racing Engine) into the cooling head. The engine is now rebuilt and ready for the installation of the clutch assembly and the EZ-Start system (if so equipped).

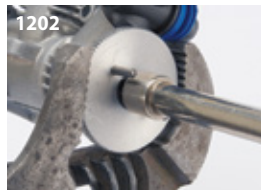

12. Slide the split cone washer over the pilot shaft with the larger end of the taper toward the engine case (1201). Slide the flywheel over the pilot shaft



and onto the split cone washer. The split cone washer should fit inside of the tapered hole in the flywheel. Thread the flywheel nut all the way up to the flywheel and tighten the flywheel to 55-65 in-lbs. of torque against the flywheel (1202).



13. Slide the clutch shoes onto the flywheel. Key the flywheel pins into the holes of the clutch shoes (See picture 1301 for orientation of the clutch shoes). **Tip:** By reversing the direction of the clutch shoes, the clutch shoes will provide a little firmer bite against the interior wall of the clutch bell. This is useful on higher bite surfaces that offer a higher level of traction.



14. Clean and lube both clutch bell bearings and install a ball bearing into each side the clutch bell and slide the clutch bell over the pilot shaft, followed by the 5x8x0.5PTW (1401).

With safety glasses on, fasten the 5.0 E-clip around the pilot shaft to retain the clutch assembly. **Note:** The Nitro 4-Tec will need two 5x8x0.5PTW placed onto the pilot shaft before the installation of the clutch bell, then secure the assembly with the 3x10CS screw.

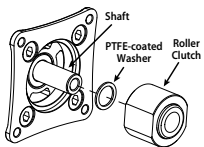

15. Clean the roller clutch with denatured alcohol or electric motor spray, and lube the roller clutch with Mobil 1® 5W30 oil. Slide the PTFE-coated washer and roller clutch onto the starter shaft as shown (1501).



Note: The roller clutch is to be installed onto the starter shaft so that the clutch engages the starter shaft clockwise and rotates freely counterclockwise. The engraved text on the roller clutch faces the engine backplate for correct rotation.

Slide the EZ-Start system or pull start onto the starter shaft that exits the backplate of the engine. Line up the drive with the roller clutch. Fasten the EZ-Start gear case to the backplate with three 3x12BCS screws (1502), or the pull starter with four 3x12BCS.



16. Inspect the exhaust O-ring and replace it if it is damaged. Fasten the exhaust header and pipe assembly back onto the rear of the engine case with the two 3x15CS screws (1601).

17. Reinstall the head protector (requires five 3x8CCS on the TRX 3.3).

The engine, clutch, exhaust system, and starter assembly are now ready for installation into the chassis (1602).

Follow the instructions for the proper break-in procedure of a new TRX Racing Engine (page 19).



- .20; 7
- ABC; 7, 19
- After-run Procedure; 34, 35
- Air Filter; 5, 6, 7, 8, 14
 - filter foam*; 8
- Air Intake; 6
- Backplate; 6
- Break-in; 7, 14, 19, 21, 22, 23
 - Tank 1*; 21
 - Tank 2*; 21
 - Tank 3*; 22
 - Tank 4*; 22
 - Tank 5*; 22
 - Tank 6*; 23
- Carburetor; 6, 7
 - carb*; 7
 - factory settings*; 16
 - fine tuning*; 27
 - slide*; 10
- Clean-out; 7
- Clutch Bell; 6
- Combustion chamber; 7
- Connecting rod; 7
- Cooling fins; 8
- Crankcase; 6, 7
- Crankshaft; 6, 7
- Cylinder head; 8
 - head protector*; 6
 - PowerTune™ head*; 6
- Dyno; 8
- EZ-Start; 8
- Fit; 8
- Flame-out; 8
- Flywheel; 6
- Fuel; 8
 - intake*; 6
 - tubing*; 8
- Fuel Mixture; 8
 - high-speed mixture*; *See High-Speed Fuel Mixture Adjustment*
 - lean*; 9, 17, 18
 - leaning*; 9
 - low-speed mixture*; *See Low-Speed Fuel Mixture Adjustment*
 - rich*; 10, 18
- Glow plug; 8
 - driver*; 8
- Header; 8
- High-Speed Fuel Mixture Adjustment; 26
 - high-speed needle*; 6, 9

Idle Speed; 9, 18, 27
idle speed adjustment screw; 6, 9

Low-Speed Fuel Mixture Adjustment; 26
low-speed needle; 6, 9

Maintaining and Storing; 33

Needle valve; 9

Nitro; 9

O-ring; 9

Piston; 9

Port; 9

Priming; 10

Pull Starter; 6

Safety; 4

Sleeve; 10

Stall; 10

Starting; 20

Throttle Arm; 6

Top dead center (TDC); 10, 30, 32

Troubleshooting; 30
clearing a flood; 31

Tuned pipe; 10

Tuning; 25
by temperature; 28
fine-tuning; 27

Wear-in; 10

WOT; 10

TRX 3.3TM
RACING ENGINE

TRX 2.5RTM
RACING ENGINE

TRX 2.5TM
RACING ENGINE

TRAXXAS

6250 TRAXXAS WAY, MCKINNEY, TEXAS 75070
1-888-TRAXXAS