

V1200 1.2M

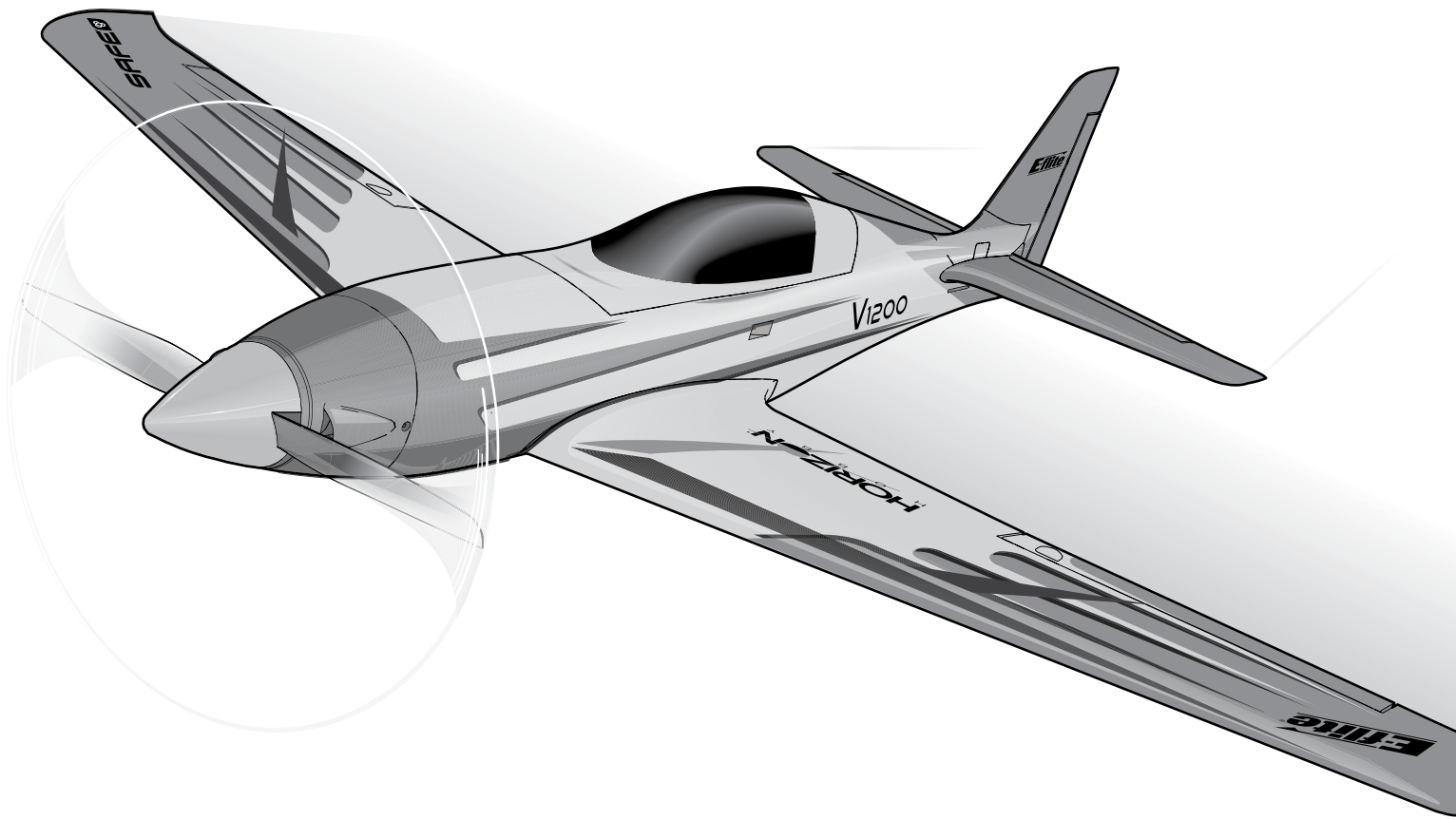

**Instruction Manual
Bedienungsanleitung
Manuel d'utilisation
Manuale di Istruzioni**

NOTICE

All instructions, warranties and other collateral documents are subject to change at the sole discretion of Horizon Hobby, LLC. For up-to-date product literature, visit horizonhobby.com or towerhobbies.com and click on the support or resources tab for this product.

MEANING OF SPECIAL LANGUAGE

The following terms are used throughout the product literature to indicate various levels of potential harm when operating this product:

WARNING: Procedures, which if not properly followed, create the probability of property damage, collateral damage, and serious injury OR create a high probability of superficial injury.

CAUTION: Procedures, which if not properly followed, create the probability of physical property damage AND a possibility of serious injury.

NOTICE: Procedures, which if not properly followed, create a possibility of physical property damage AND little or no possibility of injury.

 **WARNING:** Read the ENTIRE instruction manual to become familiar with the features of the product before operating. Failure to operate the product correctly can result in damage to the product, personal property and cause serious injury.

This is a sophisticated hobby product. It must be operated with caution and common sense and requires some basic mechanical ability. Failure to operate this Product in a safe and responsible manner could result in injury or damage to the product or other property. This product is not intended for use by children without direct adult supervision. Do not use with incompatible components or alter this product in any way outside of the instructions provided by Horizon Hobby, LLC. This manual contains instructions for safety, operation and maintenance. It is essential to read and follow all the instructions and warnings in the manual, prior to assembly, setup or use, in order to operate correctly and avoid damage or serious injury.

AGE RECOMMENDATION: Not for children under 14 years. This is not a toy.

Safety Precautions and Warnings

As the user of this product, you are solely responsible for operating in a manner that does not endanger yourself and others or result in damage to the product or the property of others.

- Always keep a safe distance in all directions around your model to avoid collisions or injury. This model is controlled by a radio signal subject to interference from many sources outside your control. Interference can cause momentary loss of control.
- Always operate your model in open spaces away from full-size vehicles, traffic and people.
- Always carefully follow the directions and warnings for this and any optional support equipment (chargers, rechargeable battery packs, etc.).
- Always keep all chemicals, small parts and anything electrical out of the reach of children.
- Always avoid water exposure to all equipment not specifically designed and protected for this purpose. Moisture causes damage to electronics.
- Never place any portion of the model in your mouth as it could cause serious injury or even death.
- Never operate your model with low transmitter batteries.
- Always keep aircraft in sight and under control.
- Always use fully charged batteries.
- Always keep transmitter powered on while aircraft is powered.
- Always remove batteries before disassembly.
- Always keep moving parts clean.
- Always keep parts dry.
- Always let parts cool after use before touching.
- Always remove batteries after use.
- Always ensure failsafe is properly set before flying.
- Never operate aircraft with damaged wiring.
- Never touch moving parts.

 **WARNING AGAINST COUNTERFEIT PRODUCTS:** If you ever need to replace your Spektrum receiver found in a Horizon Hobby product, always purchase from Horizon Hobby, LLC or a Horizon Hobby authorized dealer to ensure authentic high-quality Spektrum product. Horizon Hobby, LLC disclaims all support and warranty with regards, but not limited to, compatibility and performance of counterfeit products or products claiming compatibility with DSM or Spektrum technology.

Quick Start Information			
Transmitter Setup	1. Blank (Acro) Model		
	2. Wing Type: 1 Aileron, 1 Flap		
	3. Servo Reversing: Gear Reversed, All Others Normal		
	4. Travel Adjust (All Surfaces): 100%		
Dual Rates*		High Rate	Low Rate
	Aileron (at root)	▲ = 12mm ▼ = 12mm	▲ = 8mm ▼ = 8mm
	Elevator (at tip)	▲ = 8mm ▼ = 8mm	▲ = 6mm ▼ = 6mm
	Rudder (at top)	▶ = 10mm ◀ = 10mm	▶ = 6mm ◀ = 6mm
Flap Travel	Half ▼ = 13mm	Full ▼ = 22mm	
EXPO (Soft center)		High Rate	Low Rate
	Aileron	10%	5%
	Elevator	10%	5%
	Rudder	10%	5%
Center of Gravity (CG)	120mm back from the leading edge of the wing, measured at the wing root		
Flight Timer Setting	4 minutes		

Box Contents

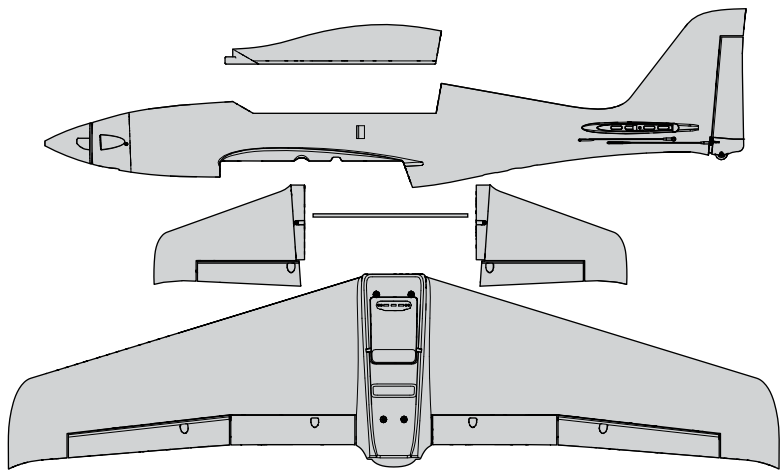

Specifications

	ENF BASIC	PNP PLUG-N-PLAY
Motor: Brushless outrunner, 800Kv (EFLM5065V)	Installed	Installed
ESC: Avian 100 Amp Brushless Smart ESC, 3S-6S (SPMXAE1100)	Installed	Installed
Servos: 9 gram metal gear digital servo (SPMSA370)	Installed	Installed
Retracts: Main Gear (EFLG125V)	Installed	Installed
Receiver: Spektrum™ AR637T DSMX 6-Channel AS3X Telemetry Receiver (SPMAR637T)	Installed	Required to Complete
Recommended Battery: 22.2V 4000–5000mAh 30–40C 6S LiPo with IC5®/EC5™ connector	Required to Complete	Required to Complete
Recommended Battery Charger: 6-cell Li-Po battery balancing charger	Required to Complete	Required to Complete
Recommended Transmitter: 6+ channel, Full-Range 2.4GHz with Spektrum™ DSM2®/DSMX® technology and adjustable dual rates	Required to Complete	Required to Complete

Table of Contents

SAFE® Select Technology	4
Preflight.....	4
Transmitter Setup	4
Model Assembly	5
Battery Installation and ESC Arming	6
Transmitter and Receiver Binding / Switching ON and OFF SAFE Select	7
SAFE® Select Switch Designation	8
Control Surface Centering	8
Control Horn and Servo Arm Settings	8
AS3X® Control Response Test	9
Propeller Installation	9
Center of Gravity (CG)	9
In Flight Trimming	10
Flying Tips and Repairs	10
PNP Receiver Selection and Installation	10
Post Flight.....	11
Motor Service	11
Troubleshooting Guide AS3X	11
Troubleshooting Guide	12
AMA National Model Aircraft Safety Code	13
Limited Warranty	13
Contact Information	14
FCC Information.....	14
IC Information	14
Compliance Information for the European Union.....	14
Replacement Parts.....	53
Recommended Parts.....	53
Optional Parts	53

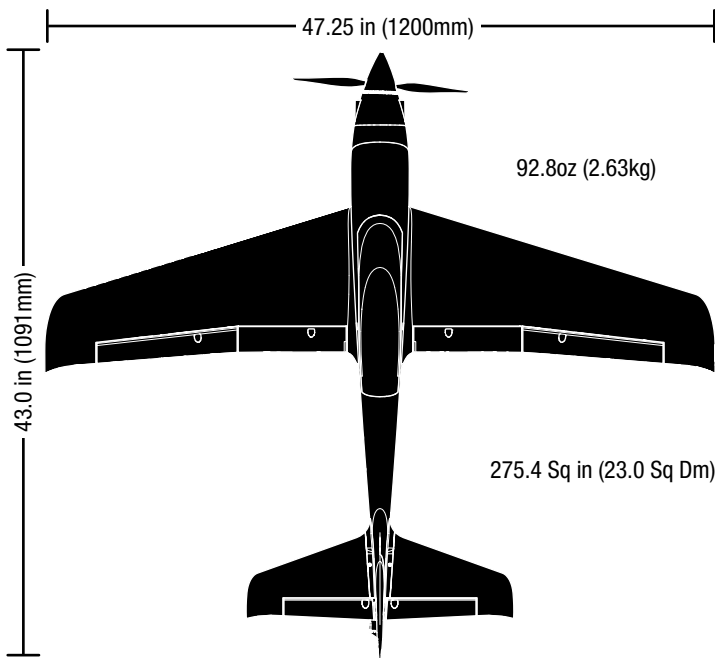

SAFE® Select Technology

The evolutionary SAFE® Select technology can offer an extra level of protection so you can perform the first flight with confidence. No complex transmitter programming is required. Just follow the simple bind process to make the SAFE Select system active. When activated, bank and pitch limitations keep you from over-controlling and automatic self-leveling makes recovery from risky or confusing attitudes as simple as releasing the sticks. In fact, with the aileron, elevator and rudder sticks in the neutral position, SAFE Select will automatically keep the airplane in a straight and level attitude.

Expand the advantage of what SAFE Select technology offers by assigning it to a switch. No transmitter programming is required and you'll be able to turn the system ON and OFF with the flip of a switch. For example, turn SAFE select ON for

takeoffs to counter the torque of the propeller. Turn it OFF in flight for unrestricted aerobatic performance, and turn it back ON when a buddy wants to try out your cool aircraft. Turn SAFE Select ON for landings. As you drop the flaps, SAFE Select reduces your workload by compensating for pitch changes automatically, regardless of throttle position. It will help keep the correct pitch attitude and wings level during the final approach. Whether you're a beginner or an expert, SAFE Select can make your flights a great experience.

When the normal bind process is followed, the SAFE Select system is disabled, leaving specially tuned AS3X® technology in place to deliver a pure, unrestricted flight experience.

Preflight

1. Remove and inspect contents.

2. Read this instruction manual thoroughly.

3. Charge the flight battery.

4. Setup Transmitter using transmitter setup chart.

5. Fully assemble the airplane.

6. Install the flight battery in the aircraft (once it has been fully charged).

7. Check the Center of Gravity (CG).

8. Bind the aircraft to your transmitter.

9. Make sure linkages move freely.

10. Perform the Control Direction Test with the transmitter.

11. Perform the AS3X Control Direction Test with the aircraft.

12. Adjust flight controls and transmitter.

13. Perform a radio system Range Test.

14. Install the propeller and spinner.

15. Find a safe open area to fly.

16. Plan flight for flying field conditions.

Transmitter Setup

IMPORTANT: After you set up your model, always rebind the transmitter and receiver to set the desired failsafe positions.

Dual Rates

The E-Flite V1200 is a very high speed aircraft. As the speed of the aircraft increases, the control response sensitivity increases. For normal, high speed flight, the control rates should be set to **low** rates. When the aircraft is traveling at lower speeds, during takeoff and landing, the rates should be set to **high** for better control response.

Take first flights in Low Rate. For landings, use high rate elevator.

NOTICE: To ensure AS3X® technology functions properly, do not lower rate values below 50%. If lower rates are desired, manually adjust the position of the pushrods on the servo arm.

NOTICE: If oscillation occurs at high speed, refer to the Troubleshooting Guide for more information.

Expo

After first flights, you may adjust expo in your transmitter.

Computerized Transmitter Setup (DX6i, DX6, DX7, DX7S, DX8, DX9, DX10t, DX18, DX20, iX12, iX20)

Start all transmitter programming with a blank ACRO model (perform a model reset), then name the model.

Set Dual Rates to	HIGH 100%
	LOW 70%
Set Servo Travel to	100%
DX6i	1. Go to the SETUP LIST MENU 2. Set MODEL TYPE: ACRO
DX7S DX8	1. Go to the SYSTEM SETUP 2. Set MODEL TYPE: AIRPLANE 3. Set WING TYPE: 1 AILERON, 1 FLAP
DX6e DX6 (Gen2) DX7 (Gen2) DX8 (Gen2) DX9 DX10t DX18 DX20 iX12† iX20†	1. Go to the SYSTEM SETUP 2. Set MODEL TYPE: AIRPLANE 3. Set AIRCRAFT WING: 1 AILERON, 1 FLAP

† Some of the terminology and function locations used in the iX12 programming may be slightly different than other Spektrum AirWare™ radios. The names given in parentheses correspond to the iX12 programming terminology. Consult your transmitter manual for specific information about programming your transmitter.

* **Flap programming values may vary slightly. For your initial flights use the recommended flap travel settings provided in the Flaps section and adjust the flap travel to your preference on subsequent flights.**



WARNING: Before proceeding, remove the spinner and propeller from the motor shaft. Never attempt to program the radio components, assemble the aircraft or perform maintenance of any kind without removing the propeller or engaging throttle cut. Serious injury could result if the motor starts inadvertently with the propeller still attached.

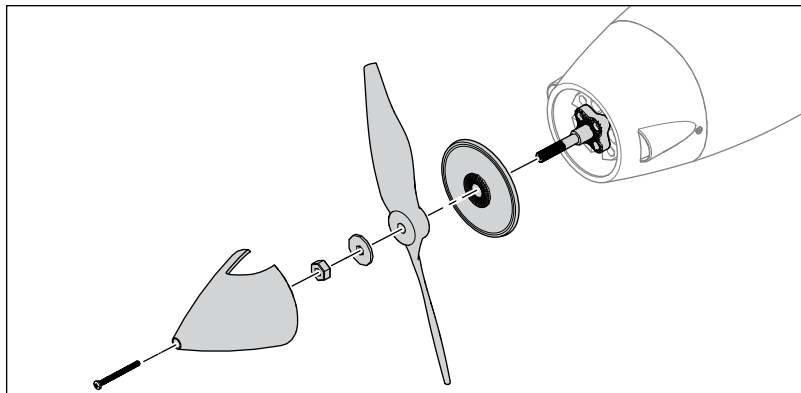

Model Assembly

Horizontal Stabilizer Installation

1. Insert the carbon horizontal stabilizer tube (A) through the hole in the fuselage.
2. Slide one side of the horizontal stabilizer halves onto the tube.
3. Using a #1 Phillips screwdriver, secure the horizontal stabilizer to the fuselage with a M2 x 10mm screw (B).
4. Snap the ball link (C) onto the pre-installed ball (D) on the elevator control horn.
5. Repeat steps 2-4 for the other horizontal stabilizer half.

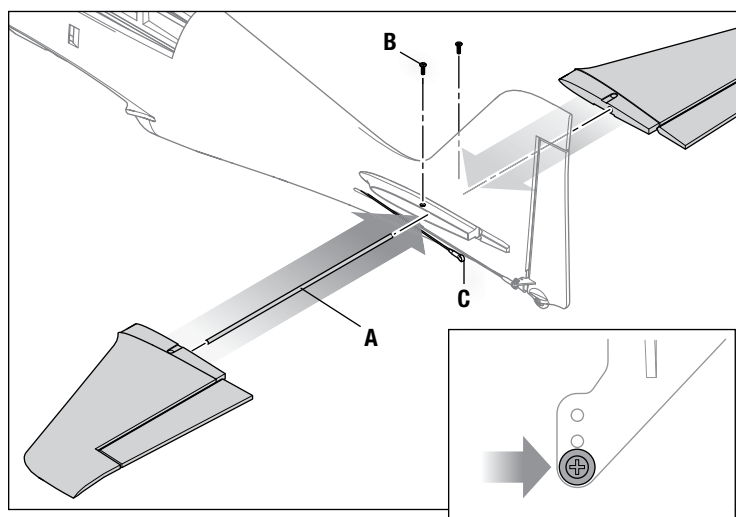

Wing Installation

1. Press the wing into the fuselage, ensuring the pins in the wing servo connector plate align with the corresponding holes in the fuselage plate (A).

CAUTION: The wing servo connections should fit easily into the fuselage. Do not force the connections together. If resistance is encountered in the connection, check the alignment of the pins and connectors and try again.

2. Using a #1 Phillips screwdriver, install 2 M4 x 50mm screws (B) in the rear wing holes. Do not overtighten.
3. Install 2 M4 x 30mm screws (C) in the front wing holes. Do not overtighten.

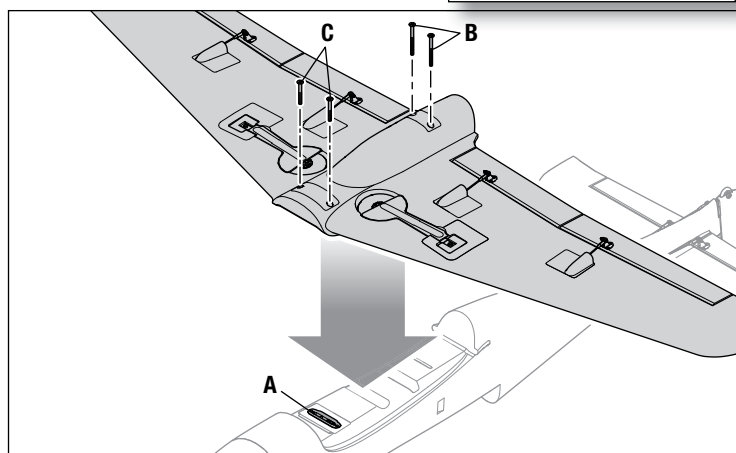

Control Surface Centering

After assembly and transmitter setup, confirm that the control surfaces are centered. If the control surfaces are not centered, mechanically center the control surfaces by adjusting the linkages.

If adjustment is required, turn the ball link on the linkage to change the length of the linkage between the servo arm and the control horn.

After binding a transmitter to the aircraft receiver, set the trims and sub-trims to 0, then adjust the ball links to center the control surfaces.

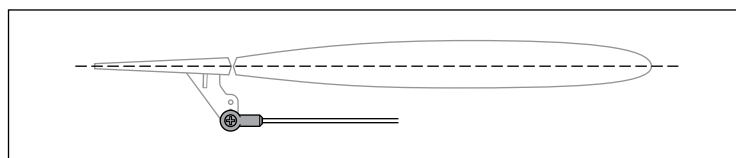

Battery Installation and ESC Arming

The Spektrum™ Smart 5000mAh 6S 30C Li-Po battery (SPMX50006S30) is recommended for best performance. Refer to the Optional Parts List for other recommended batteries. If using a battery other than those listed, the battery should be within the range of capacity, dimensions and weight of the Spektrum Li-Po battery pack to fit in the fuselage. Be sure the model balances at the recommended CG before flying.

⚠ WARNING: Always keep hands away from the propeller. When armed, the motor will turn the propeller in response to any throttle movement. If your transmitter supports it, always engage throttle cut before approaching the aircraft any time a battery is connected.

1. Lower the throttle and throttle trim to the lowest settings. Power on the transmitter, then wait 5 seconds.
2. Firmly grip the rear of the fuselage and pull the rear of the hatch **(A)** up to remove the hatch from the fuselage.
3. Install the fully charged battery **(B)** in the middle of the battery compartment, as shown. Secure using the two included hook and loop straps **(C)**.
4. Connect the battery to the ESC (the ESC is now armed).
5. Keep the aircraft immobile and away from wind or the system will not initialize.
 - The ESC will sound a series of tones.
 - An LED will light on the receiver.
 - If the ESC sounds a continuous double beep after the flight battery is connected, recharge or replace the battery.
6. Reinstall the canopy hatch.

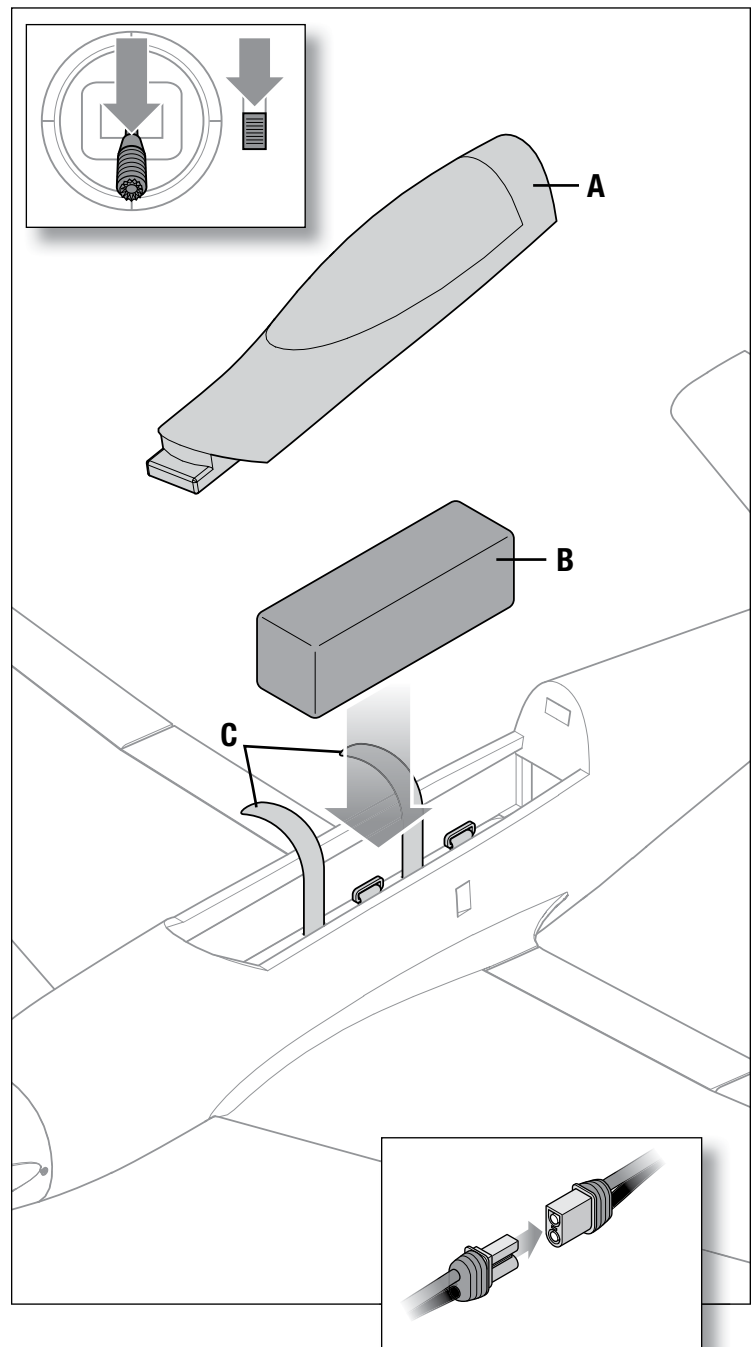

Transmitter and Receiver Binding / Switching ON and OFF SAFE Select

General Binding Tips

- The included receiver has been specifically programmed for operation of this aircraft. Refer to the receiver manual for correct setup if the receiver is replaced.
- Keep away from large metal objects while binding.
- Do not point the transmitter's antenna directly at the receiver while binding.
- The orange LED on the receiver will flash rapidly when the receiver enters bind mode.
- Once bound, the receiver will retain its bind settings for that transmitter until you re-bind.
- If the receiver loses transmitter communication, the failsafe will activate. Failsafe moves the throttle channel to low throttle. Pitch and roll channels move to actively level the aircraft in flight.
- If problems occur, refer to the troubleshooting guide or if needed, contact the appropriate Horizon Product Support office.

SAFE Select Technology, Optional Flight Envelope Protection

The BNF Basic version of this airplane includes SAFE Select technology, enabling you to choose the level of flight protection. SAFE mode includes angle limits and automatic self leveling. AS3X mode provides the pilot with a direct response to the control sticks. SAFE Select is enabled or disabled during the bind process. With SAFE Select disabled the aircraft is always in AS3X mode. With SAFE Select enabled the aircraft will be in SAFE Select mode all the time, or you can assign a switch to toggle between SAFE Select and AS3X modes.

Thanks to SAFE Select technology, this aircraft can be configured for full-time SAFE mode, full-time AS3X mode, or mode selection can be assigned to a switch.

IMPORTANT: Before binding, read the transmitter setup section in this manual and complete the transmitter setup table to ensure your transmitter is properly programmed for this aircraft.

IMPORTANT: Move the transmitter flight controls (rudder, elevators, and ailerons) and the throttle trim to neutral. Move the throttle to low before and during binding. This process defines the failsafe settings.

You can use either the **bind button** on the receiver case **OR** a conventional **bind plug** to complete the binding and SAFE Select process.

Using The Bind Button...

To Enable SAFE Select

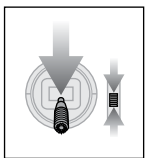

Lower Throttle

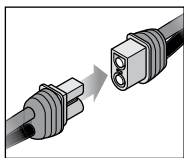

Connect Power

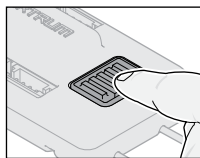

Press and hold Bind Button

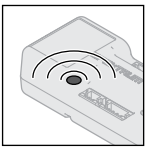

Orange Flashing LED

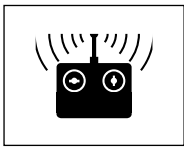

Bind TX to RX

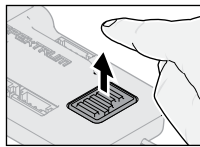

Release Bind Button

SAFE SELECT ENABLED: The control surfaces cycle back and forth **twice** with a slight pause at neutral position every time the receiver is powered on.

To Disable SAFE Select

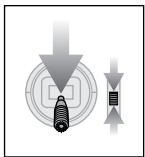

Lower Throttle

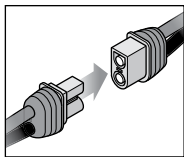

Connect Power

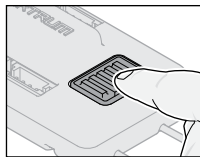

Press and hold Bind Button

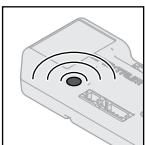

Orange Flashing LED

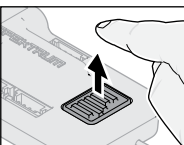

Release Bind Button

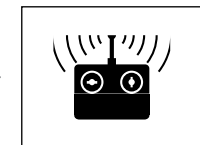

Bind TX to RX

SAFE SELECT DISABLED: The control surfaces cycle back and forth **once** every time the receiver is powered on.

Using The Bind Plug...

To Enable SAFE Select

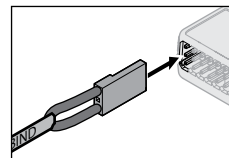

Install Bind Plug

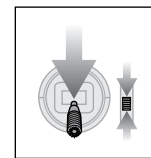

Lower Throttle

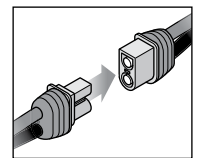

Connect Power

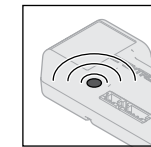

Orange Flashing LED

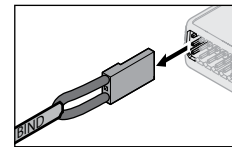

Remove Bind Plug

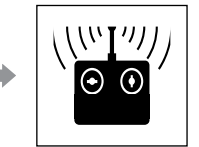

Bind TX to RX

SAFE SELECT ENABLED: The control surfaces cycle back and forth **twice** with a slight pause at neutral position every time the receiver is powered on.

To Disable SAFE Select

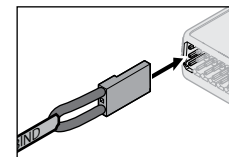

Install Bind Plug

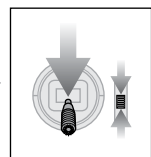

Lower Throttle

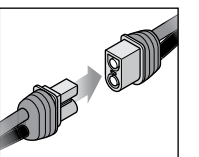

Connect Power

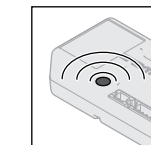

Orange Flashing LED

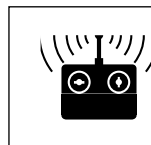

Bind TX to RX

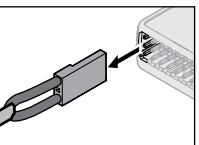

Remove Bind Plug

SAFE SELECT DISABLED: The control surfaces cycle back and forth **once** every time the receiver is powered on.

SAFE® Select Switch Designation

Once SAFE Select is enabled, you can choose to fly in SAFE mode full-time, or assign a switch. Any switch on any channel between 5 and 9 can be used on your transmitter.

If the aircraft is bound with SAFE Select disabled, the aircraft will be in AS3X mode exclusively.

CAUTION: Keep all body parts well clear of the propeller and keep the aircraft securely restrained in case of accidental throttle activation.

IMPORTANT: To be able to assign a switch, first verify:

- The aircraft was bound with SAFE Select enabled.
- Your choice for the SAFE Select switch is assigned to a channel between 5 and 9 (Gear, Aux1-4), and travel is set at 100% in each direction.
- The aileron, elevator, rudder and throttle direction are set to normal, not reverse.
- The aileron, elevator, rudder and throttle are set to 100% travel. If dual rates are in use, the switches need to be in the 100% position.

See your transmitter manual for more information about assigning a switch to a channel.

Assigning a Switch

1. Power on the transmitter.
2. Power on the aircraft.

3. Hold both transmitter sticks to the inside bottom corners, and toggle the desired switch 5 times quickly (1 toggle = full up and down).

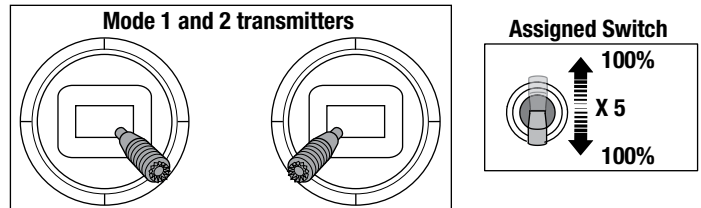

TIP: Use the channel monitor to verify channel movement.*

4. The control surfaces of the aircraft will move, indicating the switch has been selected.
- Repeat the process to assign a different switch or to deactivate the current switch.

* This example of the channel monitor shows the stick positions for assigning a switch, the switch selection on Aux2, and +/- 100% travel on the switch.

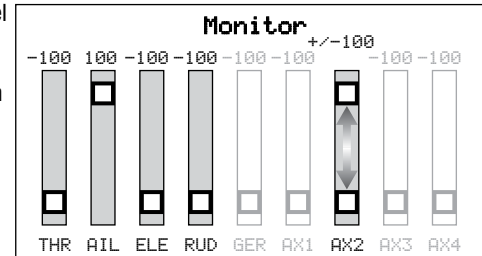

Control Surface Centering

After assembly and transmitter setup, set the transmitter trims and sub-trims to 0. Confirm the control surfaces are centered. If the surfaces are not centered, mechanically center the control surfaces by adjusting the length of the linkages as follows:

1. Using a #1 phillips screwdriver and pliers, remove the machine screw and locknut holding the ball link to the control horn.
2. Turn the ball link in or out on the pushrod to adjust the length of the linkage.
3. Insert the machine screw through the ball link and the desired hole in the control horn.
4. Install the lock nut and tighten securely. Do not overtighten.

Control Horn and Servo Arm Settings

The table to the right shows the factory settings for the control horns and servo arms. Fly the aircraft at factory settings before making changes.

NOTICE: If control throws are changed from the factory settings, the AR637TA gain values may need to be adjusted. Refer to the Spektrum AR637TA manual for adjustment of gain values.

After flying, you may choose to adjust the linkage positions for the desired control response. See the table to the right.

	Horns	Arms
Elevator		
Ailerons		
Rudder		
Flaps		

More control throw	Less control throw

AS3X® Control Response Test

WARNING: Do not perform any testing or maintenance with the propeller installed on the aircraft. Serious injury or property damage could result from the motor starting inadvertently.



This test ensures that the AS3X control system is functioning properly. Assemble the aircraft and bind your transmitter to the receiver before performing this test.

1. Raise the throttle just above 25%, then lower the throttle to activate AS3X technology.

WARNING: Keep all body parts, hair and loose clothing away from spinning motor, as these items could become entangled.

2. Move the entire aircraft as shown and ensure the control surfaces move in the direction indicated in the graphic. If the control surfaces do not respond as shown, do not fly the aircraft. Refer to the receiver manual for more information.

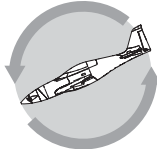
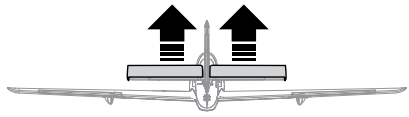
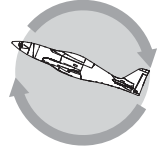
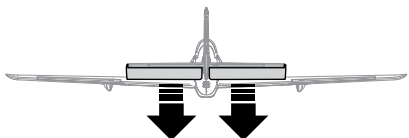
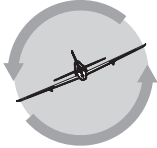
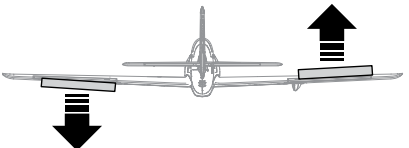
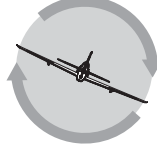
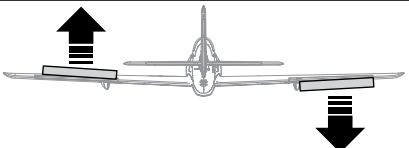
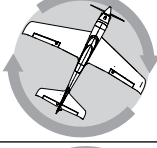
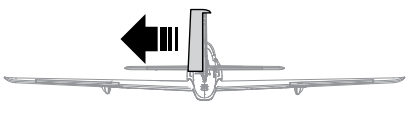
Once the AS3X system is active, control surfaces may move rapidly. This is normal. AS3X remains active until the battery is disconnected.

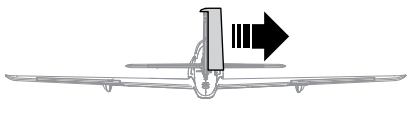
	Aircraft movement	AS3X Reaction
Elevator		
		
Aileron		
		
Rudder		
		

Propeller Installation

WARNING: Do not install the propeller until the aircraft has been completely assembled, all the systems have been checked thoroughly and you are located at a suitable flying site.

WARNING: Never install a cracked, nicked or otherwise damaged propeller.

NOTICE: If the propeller is not balanced, the aircraft may vibrate, causing the stabilization system to not operate correctly and/or decrease the life of the servos.

1. Install the prop adapter over the motor shaft.
2. Install the spinner back plate onto the prop adapter.
3. Install the propeller, ensuring the embossed size numbers are facing forward.
4. Install the prop washer and nut. Do not overtighten the prop nut as damage to the propeller or threads may result.
5. Install the spinner. Ensure the propeller blades are centered in the spinner cutouts. Allowing the spinner to contact the propeller may cause damage to the propeller and may lead to failure of the propeller.
6. Install the spinner screw using a 2mm hex driver.

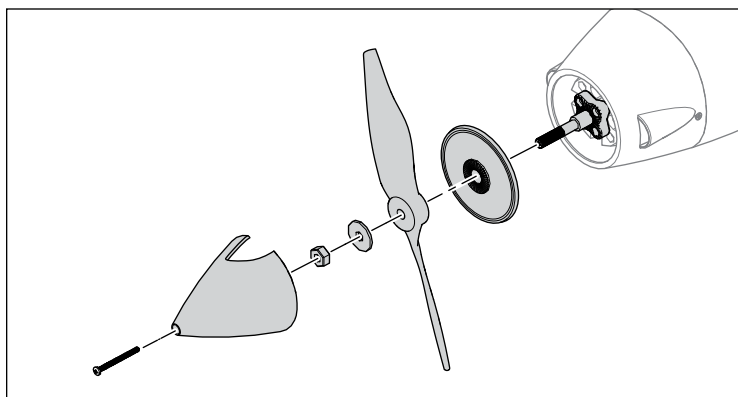

Center of Gravity (CG)

The CG location is measured 120mm (+/- 5mm) back from the leading edge of the wing at the wing root. This CG location has been determined with the recommended Li-Po battery (SPMX50006S30).

WARNING: Install the battery but **do not arm the ESC** while checking the CG. Personal injury may result.

TIP: Measure the CG with the aircraft inverted.

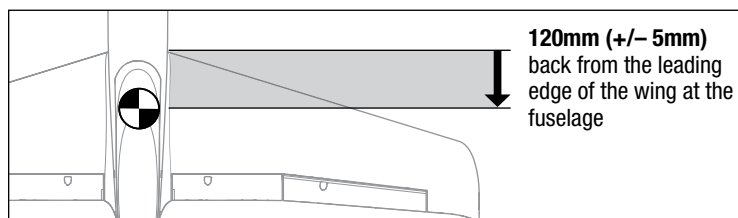

In Flight Trimming

During your first flight, trim the aircraft for level flight at 3/4 throttle with flaps up. Make small trim adjustments with your transmitter's trim switches to straighten the aircraft's flight path.

After adjusting the trim, do not touch the control sticks for 3 seconds. This allows the receiver to learn the correct settings to optimize AS3X performance.

Failure to do so could affect flight performance.

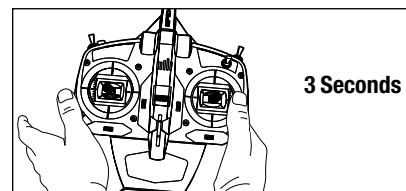

Flying Tips and Repairs

Consult local laws and ordinances before choosing a flying location.

Range Check your Radio System

Before you fly, range check the radio system. Refer to your specific transmitter instruction manual for range test information.

Oscillation

Once the AS3X system is active (after advancing the throttle for the first time), you will normally see the control surfaces react to aircraft movement. In some flight conditions you may see oscillation (the aircraft rocks back and forth on one axis due to overcontrol). If oscillation occurs, refer to the Troubleshooting Guide for more information.

Takeoff

Place the aircraft facing into the wind. Set your transmitter in low rate and use your flaps switch to drop the flaps to takeoff or "half position". Gradually increase the throttle to 3/4 and steer with the rudder. Flaps make takeoffs shorter. As the tail comes off the ground, pull back gently on the elevator. When airborne, flip your gear switch to raise your landing gear. Climb to a comfortable altitude and then flip your flaps switch to level the flaps.

Flying

For your first flights with the recommended battery pack (SPMX50006S30), set your transmitter timer or a stopwatch to 4 minutes, land the aircraft. Adjust your timer for longer or shorter flights once you have flown the model. If at any time the motor power reduces, land the aircraft immediately to recharge the flight battery. See the Low Voltage Cutoff (LVC) section for more details on maximizing battery health and run time.

Landing

Land the aircraft into the wind. Use high rate Elevator for landings. Use a small amount of throttle for the entire descent. Lower the throttle to 1/4 and flip your flaps switch to deploy the flaps to the landing or "full down position". Flaps will make the landing approach steeper and slower, and allow for a smoother landing. Flip your gear switch to lower your landing gear. This will slow the aircraft further. Keep the throttle on until the aircraft is ready to flare. During flare, keep the wings level and the aircraft pointed into the wind. Gently lower the throttle while pulling back on the elevator to bring the aircraft down on its wheels.

PNP Receiver Selection and Installation

The recommended receiver for this aircraft is the Spektrum AR637T. If you choose to install a different receiver, ensure that it is at least a 6-channel full range receiver. Refer to the manual of your chosen receiver for correct installation and operation instructions.

AR637T Installation

1. Lift the back of the canopy to remove the canopy from the fuselage.
2. Attach the appropriate control surfaces to their respective ports on the receiver using the table at the right.
3. Using double-sided servo tape, (not included) mount the receiver to the flat area behind the battery compartment, as shown. The receiver should be mounted in the orientation shown, parallel to the length of the fuselage, with the label facing up and the servo ports facing the front of the aircraft. The orientation of the receiver is critical for all AS3X and SAFE technology setups.



CAUTION: Incorrect installation of the receiver could cause a crash.

If landing on grass, it is best to hold full up elevator after touchdown and when taxiing to prevent nosing over.

Once on the ground, avoid sharp turns until the plane has slowed enough to prevent scraping the wingtips.

NOTICE: If a crash is imminent, reduce the throttle and trim fully. Failure to do so could result in extra damage to the airframe, as well as damage to the ESC and motor.

NOTICE: After any impact, always ensure the receiver is secure in the fuselage. If you replace the receiver, install the new receiver in the same orientation as the original receiver or damage may result.

NOTICE: Crash damage is not covered under warranty.

NOTICE: When you are finished flying, never leave the aircraft in direct sunlight or in a hot, enclosed area such as a car. Doing so can damage the aircraft.

Low Voltage Cutoff (LVC)

When a Li-Po battery is discharged below 3V per cell, it will not hold a charge. The ESC protects the flight battery from over-discharge using Low Voltage Cutoff (LVC). Before the battery charge decreases too much, LVC removes power supplied to the motor. Power to the motor reduces, showing that some battery power is reserved for flight control and safe landing.

Disconnect and remove the Li-Po battery from the aircraft after use to prevent trickle discharge. Charge your Li-Po battery to about half capacity before storage. During storage, make sure the battery charge does not fall below 3V per cell. LVC does not prevent the battery from over-discharge during storage.

NOTICE: Repeated flying to LVC will damage the battery.

TIP: Monitor your aircraft battery's voltage before and after flying by using a Li-Po Cell Voltage Checker (SPMXBC100, sold separately).

Repairs

Thanks to the EPO material in this aircraft, repairs to the foam can be made using virtually any adhesive (hot glue, regular CA, epoxy, etc). When parts are not repairable, see the Replacement Parts List for ordering by item number. For a listing of all replacement and optional parts, refer to the list at the end of this manual.

NOTICE: Use of CA accelerant on your aircraft can damage paint. DO NOT handle the aircraft until accelerant fully dries.

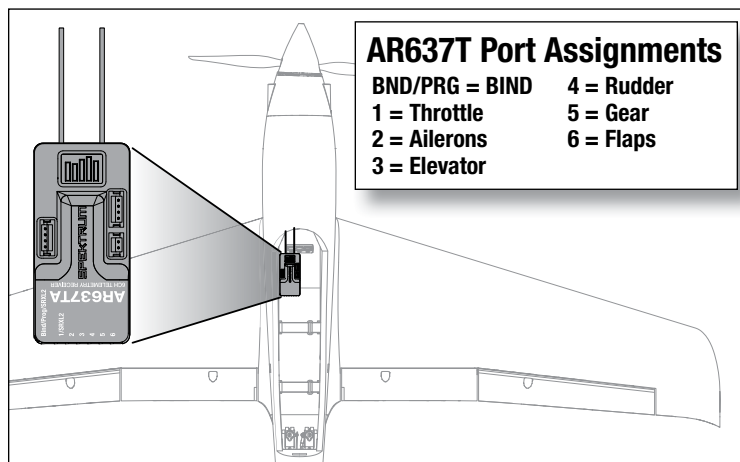

Post Flight

1. Disconnect the flight battery from the ESC (Required for safety and battery life).
2. Power OFF the transmitter.
3. Remove the flight battery from the aircraft.
4. Recharge the flight battery.

5. Repair or replace all damaged parts.
6. Store the flight battery apart from the aircraft and monitor the battery charge.
7. Make note of the flight conditions and flight plan results, planning for future flights.

Motor Service

CAUTION: Always disconnect the flight battery before performing motor service.

Disassembly

1. Remove screw (A) and spinner (B).
2. Remove the propeller nut (C), washer (D), propeller (E), backplate (F) and prop adapter (G) from the motor shaft (I).
3. Remove 3 screws (H) from the cowl (H) and remove from the fuselage.
4. Remove 4 screws (J) from the motor mount and the fuselage.
5. Disconnect the motor wires from the ESC.

Assembly

Assemble in reverse order.

- Correctly align and connect the motor wire colors with the ESC wires.
- Install the propeller with the size numbers facing forward. The propeller may require balancing.

NOTICE: If the propeller is not balanced, the aircraft may vibrate, causing the stabilization system to not operate correctly and/or decrease the life of the servos.

For more information, view our propeller balancing video on Horizon Hobby's YouTube channel:
<https://www.youtube.com/watch?v=0XuNnYQ02s4>

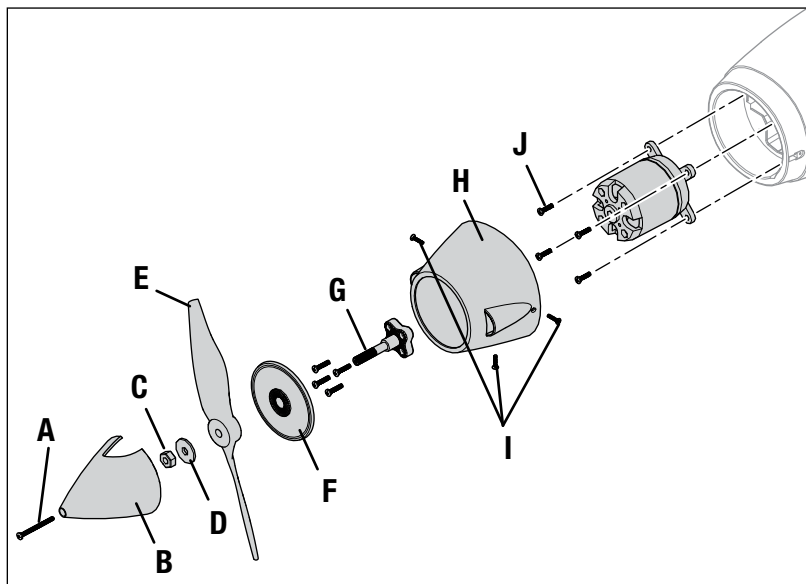

Troubleshooting Guide AS3X

Problem	Possible Cause	Solution
Oscillation	Damaged propeller or spinner	Replace propeller or spinner
	Imbalanced propeller	Balance the propeller
	Motor vibration	Replace parts or correctly align all parts and tighten fasteners as needed
	Loose receiver	Align and secure receiver in fuselage
	Loose aircraft controls	Tighten or otherwise secure parts (servo, arm, linkage, horn and control surface)
	Worn parts	Replace worn parts (especially propeller, spinner or servo)
	Irregular servo movement	Replace servo
Inconsistent flight performance	Trim is not at neutral	If you adjust trim more than 8 clicks, adjust the clevis to remove trim
	Sub-Trim is not at neutral	No Sub-Trim is allowed. Adjust the servo linkage
	Aircraft was not kept immobile for 5 seconds after battery connection	With the throttle stick in lowest position. Disconnect battery, then reconnect battery and keep the aircraft still for 5 seconds
Incorrect response to the AS3X Control Direction Test	Incorrect direction settings in the receiver, which can cause a crash	DO NOT fly. Correct the direction settings (refer to the receiver manual), then fly

Troubleshooting Guide

Problem	Possible Cause	Solution
Aircraft will not respond to throttle but responds to other controls	Throttle not at idle and/or throttle trim too high	Reset controls with throttle stick and throttle trim at lowest setting
	Throttle servo travel is lower than 100%	Make sure throttle servo travel is 100% or greater
	Throttle channel is reversed	Reverse throttle channel on transmitter
	Motor disconnected from ESC	Make sure motor is connected to the ESC
Extra propeller noise or extra vibration	Damaged propeller and spinner, collet or motor	Replace damaged parts
	Propeller is out of balance	Balance or replace propeller
	Prop nut is too loose	Tighten the prop nut
Reduced flight time or aircraft underpowered	Flight battery charge is low	Completely recharge flight battery
	Propeller installed backwards	Install propeller with numbers facing forward
	Flight battery damaged	Replace flight battery and follow flight battery instructions
	Flight conditions may be too cold	Make sure battery is warm before use
	Battery capacity too low for flight conditions	Replace battery or use a larger capacity battery
Aircraft will not Bind (during binding) to transmitter	Transmitter too near aircraft during binding process	Move powered transmitter a few feet from aircraft, disconnect and reconnect flight battery to aircraft
	Aircraft or transmitter is too close to large metal object, wireless source or another transmitter	Move aircraft and transmitter to another location and attempt binding again
	The bind plug is not installed correctly in the bind port	Install bind plug in bind port and bind the aircraft to the transmitter
	Flight battery/transmitter battery charge is too low	Replace/recharge batteries
	Bind switch or button not held long enough during the bind process	Power off transmitter and repeat bind process. Hold transmitter bind button or switch until receiver is bound
Aircraft will not connect (after binding) to transmitter	Transmitter too near aircraft during connecting process	Move powered transmitter a few feet from aircraft, disconnect and reconnect flight battery to aircraft
	Aircraft or transmitter is too close to large metal object, wireless source or another transmitter	Move aircraft and transmitter to another location and attempt connecting again
	Bind plug left installed in bind port	Rebind transmitter to the aircraft and remove the bind plug before cycling power
	Aircraft bound to different model memory (ModelMatch™ radios only)	Select correct model memory on transmitter
	Flight battery/Transmitter battery charge is too low	Replace/recharge batteries
	Transmitter may have been bound to a different aircraft using different DSM protocol	Bind aircraft to transmitter
Control surface does not move	Control surface, control horn, linkage or servo damage	Replace or repair damaged parts and adjust controls
	Wire damaged or connections loose	Do a check of wires and connections, connect or replace as needed
	Transmitter is not bound correctly or the incorrect airplanes was selected	Re-bind or select correct airplanes in transmitter
	Flight battery charge is low	Fully recharge flight battery
	BEC (Battery Elimination Circuit) of the ESC is damaged	Replace ESC
Controls reversed	Transmitter settings are reversed	Perform the Control Direction Test and adjust the controls on transmitter appropriately
Motor power pulses then motor loses power	ESC uses default soft Low Voltage Cutoff (LVC)	Recharge flight battery or replace battery that is no longer performing
	Weather conditions might be too cold	Postpone flight until weather is warmer
	Battery is old, worn out, or damaged	Replace battery
	Battery C rating might be too small	Use recommended battery

AMA National Model Aircraft Safety Code

Academy of Model Aeronautics National Model Aircraft Safety Code

Effective January 1, 2018

A model aircraft is a non-human-carrying device capable of sustained flight within visual line of sight of the pilot or spotter(s). It may not exceed limitations of this code and is intended exclusively for sport, recreation, education and/or competition. All model flights must be conducted in accordance with this safety code and related AMA guidelines, any additional rules specific to the flying site, as well as all applicable laws and regulations.

As an AMA member I agree:

- I will not fly a model aircraft in a careless or reckless manner.
- I will not interfere with and will yield the right of way to all human-carrying aircraft using AMA's See and Avoid Guidance and a spotter when appropriate.
- I will not operate any model aircraft while I am under the influence of alcohol or any drug that could adversely affect my ability to safely control the model.
- I will avoid flying directly over unprotected people, moving vehicles, and occupied structures.
- I will fly Free Flight (FF) and Control Line (CL) models in compliance with AMA's safety programming.
- I will maintain visual contact of an RC model aircraft without enhancement other than corrective lenses prescribed to me. When using an advanced flight system, such as an autopilot, or flying First-Person View (FPV), I will comply with AMA's Advanced Flight System programming.
- I will only fly models weighing more than 55 pounds, including fuel, if certified through AMA's Large Model Airplane Program.
- I will only fly a turbine-powered model aircraft in compliance with AMA's Gas Turbine Program.
- I will not fly a powered model outdoors closer than 25 feet to any individual, except for myself or my helper(s) located at the flightline, unless I am taking off and landing, or as otherwise provided in AMA's Competition Regulation.
- I will use an established safety line to separate all model aircraft operations from spectators and bystanders.

Limited Warranty

What this Warranty Covers

Horizon Hobby, LLC, (Horizon) warrants to the original purchaser that the product purchased (the "Product") will be free from defects in materials and workmanship at the date of purchase.

What is Not Covered

This warranty is not transferable and does not cover (i) cosmetic damage, (ii) damage due to acts of God, accident, misuse, abuse, negligence, commercial use, or due to improper use, installation, operation or maintenance, (iii) modification of or to any part of the Product, (iv) attempted service by anyone other than a Horizon Hobby authorized service center, (v) Product not purchased from an authorized Horizon dealer, or (vi) Product not compliant with applicable technical regulations, or (vii) use that violates any applicable laws, rules, or regulations.

OTHER THAN THE EXPRESS WARRANTY ABOVE, HORIZON MAKES NO OTHER WARRANTY OR REPRESENTATION, AND HEREBY DISCLAIMS ANY AND ALL IMPLIED WARRANTIES, INCLUDING, WITHOUT LIMITATION, THE IMPLIED WARRANTIES OF NON-INFRINGEMENT, MERCHANTABILITY AND FITNESS FOR A PARTICULAR PURPOSE. THE PURCHASER ACKNOWLEDGES THAT THEY ALONE HAVE DETERMINED THAT THE PRODUCT WILL SUITABLY MEET THE REQUIREMENTS OF THE PURCHASER'S INTENDED USE.

Purchaser's Remedy

Horizon's sole obligation and purchaser's sole and exclusive remedy shall be that Horizon will, at its option, either (i) service, or (ii) replace, any Product determined by Horizon to be defective. Horizon reserves the right to inspect any and all Product(s) involved in a warranty claim. Service or replacement decisions are at the sole discretion of Horizon. Proof of purchase is required for all warranty claims. SERVICE OR REPLACEMENT AS PROVIDED UNDER THIS WARRANTY IS THE PURCHASER'S SOLE AND EXCLUSIVE REMEDY.

Limitation of Liability

HORIZON SHALL NOT BE LIABLE FOR SPECIAL, INDIRECT, INCIDENTAL OR CONSEQUENTIAL DAMAGES, LOSS OF PROFITS OR PRODUCTION OR COMMERCIAL LOSS IN ANY WAY, REGARDLESS OF WHETHER SUCH CLAIM IS BASED IN CONTRACT, WARRANTY, TORT, NEGLIGENCE, STRICT LIABILITY OR ANY OTHER THEORY OF LIABILITY, EVEN IF HORIZON HAS BEEN ADVISED OF THE POSSIBILITY OF SUCH DAMAGES. Further, in no event shall the liability of Horizon exceed the individual price of the Product on which liability is asserted. As Horizon has no control over use, setup, final assembly, modification or misuse, no liability shall be assumed nor accepted for any resulting damage or injury. By the act of use, setup or assembly, the user accepts all resulting liability. If you as the purchaser or user are not prepared to accept the liability associated with the use of the Product, purchaser is advised to return the Product immediately in new and unused condition to the place of purchase.

Law

These terms are governed by Illinois law (without regard to conflict of law principals). This warranty gives you specific legal rights, and you may also have other rights which vary from state to state. Horizon reserves the right to change or modify this warranty at any time without notice.

WARRANTY SERVICES

Questions, Assistance, and Services

Your local hobby store and/or place of purchase cannot provide warranty support or service. Once assembly, setup or use of the Product has been started, you must contact your local distributor or Horizon directly. This will enable Horizon to better answer your questions and service you in the event that you may need any assistance. For questions or assistance, please visit our website at www.horizonhobby.com, submit a Product Support Inquiry, or call the toll free telephone number referenced in the Warranty and Service Contact Information section to speak with a Product Support representative.

Inspection or Services

If this Product needs to be inspected or serviced and is compliant in the country you live and use the Product in, please use the Horizon Online Service Request submission process found on our website or call Horizon to obtain a Return Merchandise Authorization (RMA) number. Pack the Product securely using a shipping carton. Please note that original boxes may be included, but are not designed to withstand the rigors of shipping without additional protection. Ship via a carrier that provides tracking and insurance for lost or damaged parcels, as Horizon is not responsible for merchandise until it arrives and is accepted at our facility. An Online Service Request is available at http://www.horizonhobby.com/content/service-center_render-service-center. If you do not have internet access, please contact Horizon Product Support to obtain a RMA number along with instructions for submitting your product for service. When calling Horizon, you will be asked to provide your complete name, street address, email address and phone number where you can be reached during business hours. When sending product into Horizon, please include your RMA number, a list of the included items, and a brief summary of the problem. A copy of your original sales receipt must be included for warranty consideration. Be sure your name, address, and RMA number are clearly written on the outside of the shipping carton.

NOTICE: Do not ship LiPo batteries to Horizon. If you have any issue with a LiPo battery, please contact the appropriate Horizon Product Support office.

Warranty Requirements

For Warranty consideration, you must include your original sales receipt verifying the proof-of-purchase date. Provided warranty conditions have been met, your Product will be serviced or replaced free of charge. Service or replacement decisions are at the sole discretion of Horizon.

Non-Warranty Service

Should your service not be covered by warranty, service will be completed and payment will be required without notification or estimate of the expense unless the expense exceeds 50% of the retail purchase cost. By submitting the item for service you are agreeing to payment of the service without notification. Service estimates are available upon request. You must include this request with your item submitted for service. Non-warranty service estimates will be billed a minimum of ½ hour of labor. In addition you will be billed for return freight. Horizon accepts money orders and cashier's checks, as well as Visa, MasterCard, American Express,

and Discover cards. By submitting any item to Horizon for service, you are agreeing to Horizon's Terms and Conditions found on our website http://www.horizonhobby.com/content/service-center_render-service-center.

ATTENTION: Horizon service is limited to Product compliant in the country of use and ownership. If received, a non-compliant Product will not be serviced. Further, the sender will be responsible for arranging return shipment of the un-serviced Product, through a carrier of the sender's choice and at the sender's expense. Horizon will hold non-compliant Product for a period of 60 days from notification, after which it will be discarded.

10/15

Contact Information

Country of Purchase	Horizon Hobby	Contact Information	Address
United States of America	Horizon Service Center (Repairs and Repair Requests)	servicecenter.horizonhobby.com/RequestForm/	2904 Research Rd Champaign, Illinois, 61822 USA
	Horizon Product Support (Product Technical Assistance)	productsupport@horizonhobby.com 877-504-0233	
	Sales	websales@horizonhobby.com 800-338-4639	
European Union	Horizon Technischer Service	service@horizonhobby.eu	Hanskampring 9 D 22885 Barsbüttel, Germany
	Sales: Horizon Hobby GmbH	+49 (0) 4121 2655 100	

FCC Information

FCC ID: BRWTIARLGTNG1

Supplier's Declaration of Conformity

V1200 1.2m Sport Airplane (EFL12350/EFL12375)

 This device complies with part 15 of the FCC Rules. Operation is subject to the following two conditions: (1) This device may not cause harmful interference, and (2) this device must accept any interference received, including interference that may cause undesired operation.

 **CAUTION:** Changes or modifications not expressly approved by the party responsible for compliance could void the user's authority to operate the equipment.

NOTE: This equipment has been tested and found to comply with the limits for a Class B digital device, pursuant to part 15 of the FCC Rules. These limits are designed to provide reasonable protection against harmful interference in a residential installation. This equipment generates, uses and can radiate radio frequency energy and, if not installed and used in accordance with the instructions,

may cause harmful interference to radio communications. However, there is no guarantee that interference will not occur in a particular installation. If this equipment does cause harmful interference to radio or television reception, which can be determined by turning the equipment off and on, the user is encouraged to try to correct the interference by one or more of the following measures:

- Reorient or relocate the receiving antenna.
- Increase the separation between the equipment and receiver.
- Connect the equipment into an outlet on a circuit different from that to which the receiver is connected.
- Consult the dealer or an experienced radio/TV technician for help.

Horizon Hobby, LLC
2904 Research Rd.,
Champaign, IL 61822
Email: compliance@horizonhobby.com
Web: HorizonHobby.com

IC Information

IC: 6157A-TIARLGTNG1

CAN ICES-3 (B)/NMB-3(B)

This device contains license-exempt transmitter(s)/receivers(s) that comply with Innovation, Science, and Economic Development Canada's license-exempt RSS(s). Operation is subject to the following 2 conditions:

1. This device may not cause interference.
2. This device must accept any interference, including interference that may cause undesired operation of the device.

Compliance Information for the European Union

 **EU Compliance Statement:**
V1200 1.2m Sport Airplane PNP (EFL12375); Hereby, Horizon Hobby, LLC declares that the device is in compliance with the following:
EU EMC Directive 2014/30/EU.

V1200 1.2m Sport Airplane BNF Basic (EFL12350); Hereby, Horizon Hobby, LLC declares that the device is in compliance with the following: EU Radio Equipment Directive 2014/53/EU.

The full text of the EU declaration of conformity is available at the following internet address: <https://www.horizonhobby.com/content/support-render-compliance>.

Wireless Frequency Range and Wireless Output Power:

2402 – 2476 MHz
20dBm

EU Manufacturer of Record:

Horizon Hobby, LLC
2904 Research Road
Champaign, IL 61822 USA

EU Importer of Record:

Horizon Hobby, GmbH
Hanskampring 9
22885 Barsbüttel Germany

WEEE NOTICE:



This appliance is labeled in accordance with European Directive 2012/19/EU concerning waste of electrical and electronic equipment (WEEE). This label indicates that this product should not be disposed of with household waste. It should be deposited at an appropriate facility to enable recovery and recycling.



E328

Replacement Parts • Ersatzteile • Pièces de rechange • Pezzi di ricambio

#	Description	Beschreibung	Description	Descrizione
EFL12351	Painted Fuselage	Lackierter Rumpf	Fuselage peint	Fus olera verniciata
EFL12352	Painted Wing	Lackierte Tragfläche	Aile peinte	Ala verniciata
EFL12353	Horizontal Stab	Höhenleitwerk	Stabilisateur horizontal	Stabilizzatore orizzontale
EFL12354	Battery Hatch	Akku-Abdeckung	Trappe de la batterie	Sportello batteria
EFL12355	Painted Cowl	Lackierte Motorhaube	Capot peint	Supporto verniciato
EFL12356	Decal Sheet	Decalsatz	Feuillet d'autocollants	Set decalcomanie
EFL12357	Prop Adapter	Propeller-Adapter	Adaptateur d'hélice	Adattatore elica
EFL12358	Servo Covers	Servo-Abdeckungen	Caches de servo	Carter servo
EFL12359	Landing Gear Doors	Fahrwerkklappen	Portes du train d'atterrissage	Portelli carrello di atterraggio
EFL12360	Wheel Set	Reifensatz	Ensemble roue	Kit ruote
EFL12361	Pushrod Set	Gestängesatz	Ensemble barre de liaison	Kit aste di comando
EFL12362	Hardware Set	Hardwaresatz	Ensemble matériel	Kit bulloneria
EFL12363	Motor Mount	Motorhalterung	Support moteur	Montante motore
EFL12364	Landing Gear Wire	Fahrwerk-Kabel	Fil du train d'atterrissage	Filo del carrello di atterraggio
EFLG125V	10-15 90-Deg Retract Unit	Einfahreinheit 10-15 90-Deg	Système de rentrée 10-15 90 degrés	Unità di ritrazione 10-15 90°
EFLM5065V	5065 Brushless outrunner: 800Kv	5065 Bürstenloser Außenläufer: 800KV	Cage tournante sans balais 5065 : 800 Kv	5065 Brushless Outrunner: 800 Kv
EFLSP250U	2.50" Aluminum Spinner	Aluminum-Spinner 6,35 cm (2,50")	Cône en aluminium 6,35 cm (2,5 po)	Ogiva in alluminio da 6,35 cm (2,50")
SPMAR637T	AR637T 6CH SAFE and AS3X TelemRX	AR637T SAFE mit 6 Kanälen und AS3X-Telemetrieempfänger	Récepteur de télémétrie 6 canaux SAFE et AS3X AR637T	Ricevitore telemetrico AR637T 6 canali SAFE e AS3X
SPMSA370	9 Gram Digital Metal Gear Servo	9 g digitaler Metallgetriebe-Servo	mini servo numérique à engrenages métalliques de 9 g	Servo digitale con ingranaggi in metallo 9 grammi
SPMXAE1100	Avian 100Amp Brushless Smart ESC 6S	Avian 100 A bürstenloser Smart-Geschwindigkeitsregler 6S	Variateur ESC sans balais 100 A Smart Avian 6S	Smart ESC 6S Avian 100 A Brushless

Recommended Parts • Empfohlene Teile • Pièces recommandées • Parti consigliate

#	Description	Beschreibung	Description	Descrizione
SPMR8105	DX8e 8 Channel Transmitter Only	Nur DX8e-Sender mit 8 Kanälen	Émetteur uniquement 8 canaux DX8e	DX8e 8 canali solo trasmittente
SPMX50006S30	5000mAh 6S 22.2V Smart 30C; IC5	5000 mAh 6S 22,2 V Smart 30C; IC5	5000 mAh 6S 22,2 V Smart 30 C ; IC5	5000 mAh 6S 22,2 V Smart 30C; IC5
SPMXC1080	Smart S1100 AC Charger, 1x100W	Smart S1100 Wechselstrom-Ladegerät, 1x100 W	Chargeur c.a. Smart S1100, 1 x 100 W	Caricabatterie Smart S1100 CA, 1x100 W
SPMXCA508	Adapter: IC5 Battery/IC3 Device	Adapter: IC5-Akku/IC3-Gerät	Adaptateur : batterie IC5/dispositif IC3	Adattatore: da IC5 batteria a IC3 dispositivo

Optional Parts • Optionale Bauteile • Pièces optionnelles • Pezzi opzionali

#	Description	Beschreibung	Description	Descrizione
DYN1400	LiPo Charge Protection Bag, Small	LiPo Ladeschutzbeutel, klein	Sac de protection du chargeur de batterie Li-Po, petit	Sacchetto di protezione per batteria LiPo, piccolo
DYN1405	LiPo Charge Protection Bag, Large	LiPo Ladeschutzbeutel, groß	Sac de protection du chargeur de batterie Li-Po, large	Sacchetto di protezione per batteria LiPo, grande
SPMXC1010	Smart S2100 AC Charger, 2x100W	Smart S2100 Wechselstrom-Ladegerät, 2x100 W	Chargeur c.a. Smart S2100, 2 x 100 W	Caricabatterie Smart S2100 CA, 2x100 W
SPMXBC100	XBC100 Smart LiPo Battery Checker & Servo Driver	XBC100 Smart-LiPo-Akkuprüfer und Servotreiber	Contrôleur pour batterie Li-Po Smart XBC100 et servomoteur	Servo driver e tester batteria Li-Po Smart XBC100
EFLA250	Park Flyer Tool Asst, 5 pc	Parkflyer-Tool Asst, 5 pc	Assortiment d'outils Park Flyer 5 pièces	Assort. utensili Park Flyer, 5 pz.
	DX6e DSMX 6-Channel Transmitter	Spektrum DX6e DSMX 6-Kanal Sender	Émetteur DX6e DSMX 6 voies	DX6e DSMX Trasmettitore 6 canali
	DX6 G2/3DSMX 6-Channel Transmitter	Spektrum DX6 DSMX 6-Kanal Sender	Émetteur DX6 DSMX 6 voies	DX6 DSMX Trasmettitore 6 canali
	DX8e DSMX 8-Channel Transmitter	Spektrum DX8e DSMX 8 Kanal Sender	Émetteur DX8e DSMX 8 voies	DX8e DSMX Trasmettitore 8 canali
	DX8G2 DSMX 8-Channel Transmitter	Spektrum DX8G2 DSMX 8 Kanal Sender	Émetteur DX8G2 DSMX 8 voies	DX8G2 DSMX Trasmettitore 8 canali
	DX9 DSMX 9-Channel Transmitter	Spektrum DX9 DSMX 9 Kanal Sender	Émetteur DX9 DSMX 9 voies	DX9 DSMX Trasmettitore 9 canali
	iX12 DSMX 12-Channel Transmitter	Spektrum iX12 DSMX 12 Kanal Sender	Émetteur iX12 DSMX 12 voies	iX12 DSMX Trasmettitore 12 canali
	iX20 DSMX 20-Channel Transmitter	Spektrum iX20 DSMX 20 Kanal Sender	Émetteur iX20 DSMX 12 voies	iX20 DSMX Trasmettitore 20 canali



© 2020 Horizon Hobby, LLC.

E-flite, V1200, Avian, DSM, DSM2, DSMX, Bind-N-Fly, BNF, the BNF logo, Plug-N-Play, AS3X, SAFE, the SAFE logo, ModelMatch, IC5, EC5, and the Horizon Hobby logo are trademarks or registered trademarks of Horizon Hobby, LLC.

The Spektrum trademark is used with permission of Bachmann Industries, Inc.

All other trademarks, service marks and logos are property of their respective owners.

US 8,672,726. US 9,056,667. US 9,753,457. US 10,333,322. US 9,930,567. US 10,419,970. Other patents pending.
<https://www.horizonhobby.com/content/e-flite-rc>