

E-flite[®]
ADVANCING ELECTRIC FLIGHT

UMX™ Pitts® S-1S

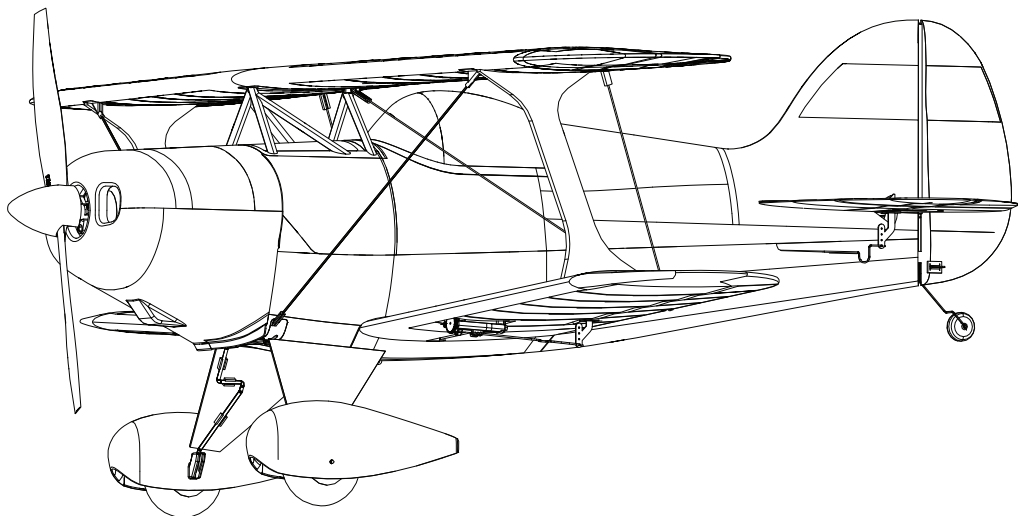

Scan the QR code and select the Manuals and Support quick links from the product page for the most up-to-date manual information.

Scannen Sie den QR-Code und wählen Sie auf der Produktseite die Quicklinks Handbücher und Unterstützung, um die aktuellsten Informationen zu Handbüchern.

Scannez le code QR et sélectionnez les liens rapides Manuals and Support sur la page du produit pour obtenir les informations les plus récentes sur le manuel.

Scannerizzare il codice QR e selezionare i Link veloci Manuali e Supporto dalla pagina del prodotto per le informazioni manuali più aggiornate.



EFLU15250

Instruction Manual
Bedienungsanleitung
Manuel d'utilisation
Manuale di Istruzioni

HORIZON[®]
H O B B Y

NOTICE

All instructions, warranties and other collateral documents are subject to change at the sole discretion of Horizon Hobby, LLC. For up-to-date product literature, visit www.horizonhobby.com or towerhobbies.com and click on the support or resources tab for this product.

MEANING OF SPECIAL LANGUAGE

The following terms are used throughout the product literature to indicate various levels of potential harm when operating this product:

WARNING: Procedures, which if not properly followed, create the probability of property damage, collateral damage, and serious injury OR create a high probability of superficial injury.

CAUTION: Procedures, which if not properly followed, create the probability of physical property damage AND a possibility of serious injury.

NOTICE: Procedures, which if not properly followed, create a possibility of physical property damage AND little or no possibility of injury.



WARNING: Read the ENTIRE instruction manual to become familiar with the features of the product before operating. Failure to operate the product correctly can result in damage to the product, personal property and cause serious injury.

This is a sophisticated hobby product. It must be operated with caution and common sense and requires some basic mechanical ability. Failure to operate this Product in a safe and responsible manner could result in injury or damage to the product or other property. This product is not intended for use by children without direct adult supervision. Do not use with incompatible components or alter this product in any way outside of the instructions provided by Horizon Hobby, LLC. This manual contains instructions for safety, operation and maintenance. It is essential to read and follow all the instructions and warnings in the manual, prior to assembly, setup or use, in order to operate correctly and avoid damage or serious injury.

14+ AGE RECOMMENDATION: Not for children under 14 years. This is not a toy.

Safety Precautions and Warnings

As the user of this product, you are solely responsible for operating in a manner that does not endanger yourself and others or result in damage to the product or the property of others.

- Always keep a safe distance in all directions around your model to avoid collisions or injury. This model is controlled by a radio signal subject to interference from many sources outside your control. Interference can cause momentary loss of control.
- Always operate your model in open spaces away from full-size vehicles, traffic and people.
- Always carefully follow the directions and warnings for this and any optional support equipment (chargers, rechargeable battery packs, etc.).
- Always keep all chemicals, small parts and anything electrical out of the reach of children.
- Always avoid water exposure to all equipment not specifically designed and protected for this purpose. Moisture causes damage to electronics.
- Never place any portion of the model in your mouth as it could cause serious injury or even death.
- Never operate your model with low transmitter batteries.
- Always keep aircraft in sight and under control.
- Always use fully charged batteries.
- Always keep transmitter powered on while aircraft is powered.
- Always remove batteries before disassembly.
- Always keep moving parts clean.
- Always keep parts dry.
- Always let parts cool after use before touching.
- Always remove batteries after use.
- Always ensure failsafe is properly set before flying.
- Never operate aircraft with damaged wiring.
- Never touch moving parts.



WARNING AGAINST COUNTERFEIT PRODUCTS: If you ever need to replace your Spektrum receiver found in a Horizon Hobby product, always purchase from Horizon Hobby, LLC or a Horizon Hobby authorized dealer to ensure authentic high-quality Spektrum product. Horizon Hobby, LLC disclaims all support and warranty with regards, but not limited to, compatibility and performance of counterfeit products or products claiming compatibility with DSM or Spektrum technology.

Included / Recommended Equipment

Motor: Brushless Outrunner Motor, 1900Kv, 10-Pole (SPMXAM1208)	Installed	 <p>Without Battery: 93g (3.3 oz) With 3S 300mAh Battery: 125g (4.4 oz)</p>
Servo: (4) 2.3-Gram Long-Throw Linear Servo (SPMSA2030L)	Installed	
Receiver: Spektrum™ AS3X/SAFE Receiver (SPMA3187)	Installed	
Recommended Battery: Spektrum™ 300mAh 3S 11.1V 30C; JST-RCY Li-Po (SPMX3003SJ30)	Required	
Recommended Battery Charger: Spektrum™ S150 AC/DC Smart Charger, 1x50W (SPMXC1070) WITH IC3 to JST-RCY adapter (SPMXCA310)	Required	
Recommended Transmitter: Full-Range 2.4GHz with Spektrum™ DSM2®/DSMX® technology with programmable mixing and adjustable dual rates	Required	

Table of Contents

Low Voltage Cutoff (LVC)	4	Power Components Service	9
Transmitter Setup	4	AS3X System Trouble Shooting Guide.....	10
Transmitter and Receiver Binding.....	4	Troubleshooting Guide	10–11
Binding Procedure	4	Replacement Parts.....	12
Integrated Telemetry.....	5	Optional Parts and Accessories	12
SAFE Select Technology	5	Important Federal Aviation Administration (FAA) Information	13
ESC/Receiver Arming, Battery Installation and Center of Gravity.....	6	AMA National Model Aircraft Safety Code.....	13
Control Direction Tests	7	Limited Warranty	13
Control Centering.....	7	Contact Information	14
Control Horn Settings.....	8	FCC Information.....	15
Flying Tips and Repairs.....	8	IC Information	15
Post Flight Checklist	9	Compliance Information for the European Union.....	15

General Binding Tips and Failsafe *BNF*

- The included receiver has been specifically programmed for operation of this aircraft. Refer to the receiver manual for correct setup if the receiver is replaced.
- Keep away from large metal objects while binding.
- Do not point the transmitter's antenna directly at the receiver while binding.
- The orange LED on the receiver will flash rapidly when the receiver enters bind mode.
- Once bound, the receiver will retain its bind settings for that transmitter until you re-bind.
- If the receiver loses transmitter communication, the failsafe will activate. Failsafe moves the throttle channel to low throttle. Pitch and roll channels move to actively stabilize the aircraft in a descending turn.
- If problems occur, refer to the troubleshooting guide or if needed, contact the appropriate Horizon Product Support office.

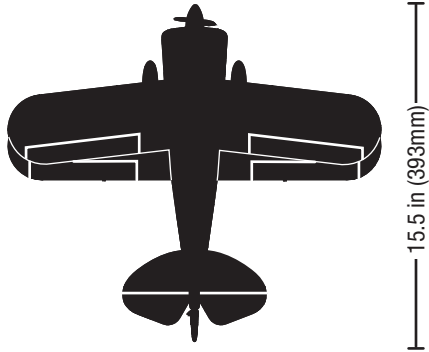
Low Voltage Cutoff (LVC)

When a Li-Po battery is discharged below 3V per cell, it will not hold a charge. The aircraft's ESC protects the flight battery from over-discharge using Low Voltage Cutoff (LVC). Once the battery discharges to 3V per cell, the LVC will reduce the power to the motor in order to leave adequate power to the receiver and servos to land the airplane.

When the motor power decreases, land the aircraft immediately and replace or recharge the flight battery.

Always disconnect and remove the Li-Po battery from the aircraft after each flight. Charge your Li-Po battery to

about half capacity before storage. Make sure the battery charge does not fall below 3V per cell. Failure to unplug a connected battery will result in trickle discharge.

For your first flights, set your transmitter timer or a stopwatch to 5 minutes. Adjust your timer for longer or shorter flights once you have flown the model.

NOTICE: Repeated flying to LVC will damage the battery.

Transmitter Setup

IMPORTANT: After you set up your model, always rebind the transmitter and receiver to set the desired failsafe positions.

If your transmitter allows it, enable the throttle cut feature. Always engage throttle cut before approaching the aircraft.

Dual Rates

Low rate is recommended for the initial flights.

NOTICE: To ensure AS3X® technology functions properly, do not lower rate values below 50%.

NOTICE: If oscillation occurs at high speed, refer to the Troubleshooting Guide for more information.

Exponential

After your initial flights, you may adjust the expo value to better suit your flying style.

Computerized Transmitter Setup

DX series, NX series, iX series

Start all transmitter programming with a blank ACRO model (do a model reset), then name the model.	
Reversing	All Normal
Dual Rates	HIGH 100%
	LOW 70%
Expo	10% on aileron, elevator and rudder
Servo Travel	100%
Timer	5 minutes
Set Throttle cut to	-100%

Transmitter and Receiver Binding

Binding is the process of programming the receiver to recognize the GUID (Globally Unique Identifier) code of a single specific transmitter. You need to 'bind' your chosen Spektrum™ DSM2/DSMX technology equipped aircraft transmitter to the receiver for proper operation.

Any full range Spektrum DSM2/DSMX transmitter can bind to the DSM2/DSMX receiver.

✓	Binding Procedure
	1. Refer to your transmitter's unique instructions for binding to a receiver (location of transmitter's Bind control).
	2. Make sure the flight battery is disconnected from the aircraft.
	3. Power off your transmitter.
	4. Place the aircraft on a level surface away from wind.
	5. Connect the flight battery in the aircraft. The receiver LED will begin to flash rapidly (typically after 5 seconds).
	6. Make sure the transmitter controls are neutral and the throttle and throttle trim are in low position.
	7. Put your transmitter into bind mode. Refer to your transmitter's manual for binding button or switch instructions.
	8. After 5 to 10 seconds, the receiver status LED will turn solid, indicating that the receiver is bound to the transmitter. If the LED does not turn solid, refer to the Troubleshooting Guide at the back of the manual.

For subsequent flights, power ON the transmitter for 5 seconds before connecting the flight battery.

Integrated Telemetry

This aircraft includes telemetry between the ESC and receiver, which can provide information including; RPM, voltage, motor current, throttle setting (%), FET (speed controller) temperature, and BEC (servo power supply) temperature.

To View Telemetry

1. Begin with the transmitter bound to the receiver.
2. Power on the transmitter.

3. Power on the aircraft.
4. A signal bar appears in the top left corner of the screen when the telemetry information is being received.
5. Scroll past the servo monitor to view the technology screens.

For more information about compatible transmitters, firmware updates, and how to use the telemetry technology on your transmitter, visit www.SpektrumRC.com.

SAFE® Select Technology

When SAFE Select is activated, bank and pitch limitations keep you from over-controlling the aircraft. Additionally, by releasing the controls in the event you lose orientation, SAFE Select will keep the aircraft level.

To activate SAFE® Select, flip the Gear channel switch to position 0. Return the Gear switch to position 1 to turn OFF SAFE Select and fly with just the assistance of AS3X® technology.

If you become disoriented or the aircraft is in a confusing attitude, flip the Gear switch to position 0 and release the sticks. With the aileron, elevator and rudder sticks in the neutral position, SAFE Select will automatically keep the airplane in a straight and level attitude.

Disabling and Enabling SAFE Select

By default, the SAFE Select function of your UMX aircraft is enabled and assigned to the Gear channel switch (channel 5). If you do not wish to have access to SAFE Select while flying, you can choose to disable SAFE Select functionality. AS3X will still be active when SAFE Select is disabled.

IMPORTANT: Before attempting to disable or enable SAFE Select, ensure the aileron, elevator, rudder, throttle and gear channels are all on high rate with the travel set to 100%. Turn throttle hold OFF if it is programmed in the transmitter.



CAUTION: Keep all body parts clear of the rotor, intake and exhaust tube and keep the aircraft securely restrained in case of accidental throttle activation.

1. Power on the transmitter.
2. Power on the aircraft.
3. Hold both transmitter sticks to the inside bottom corners and toggle the Gear switch 5 times (1 toggle = full up and down). The control surfaces of the aircraft will move, indicating SAFE Select has been enabled or disabled.

Repeat the process again to re-enable or disable SAFE Select.

DX4e, DX5e, DXe, and DXS Transmitters

The Gear switch is the FMODE switch on these transmitters, and the switch needs to be toggled between position 0 and 2 when disabling/enabling SAFE Select.

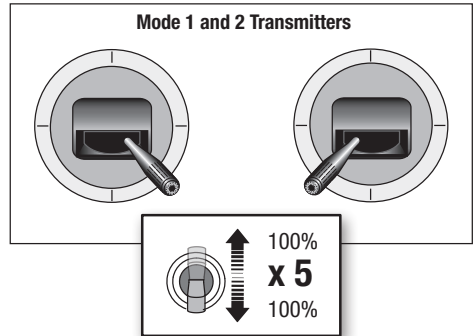

ESC/Receiver Arming, Battery Installation and Center of Gravity

CAUTION: Always keep hands away from the propeller. When armed, the motor will turn the propeller in response to any throttle movement.

Arming the ESC/receiver also occurs after binding as previously described, but subsequent connection of a flight battery requires the following steps.

AS3X

The AS3X® system will not **activate** until the throttle stick or trim is increased for the first time. Once active, the control surfaces may move rapidly and noisily on the aircraft. This is normal. AS3X technology will remain active until the battery is disconnected.

1. Remove the battery hatch from the fuselage.
2. Attach the battery to the hook and loop strip so the battery is against the motor mount.

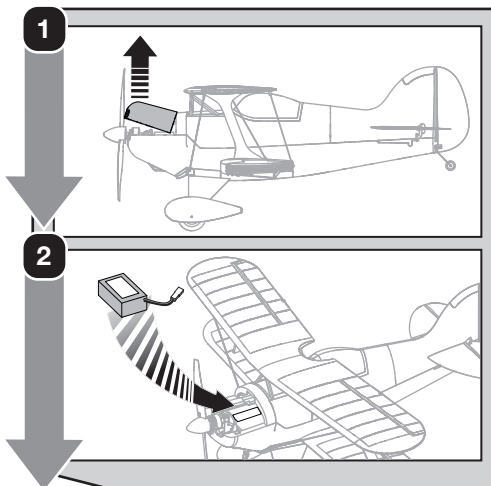

Center of Gravity (CG)

At the wing root, measure the CG location **32mm** back from the leading edge of the wing at the center section.

3. Lower the throttle and throttle trim to the lowest settings on your transmitter. Power on your transmitter, then wait 5 seconds.
4. Connect the battery to the ESC, noting proper polarity. Keep the plane immobile and away from wind for 5 seconds to allow the AS3X system to initialize. A series of tones and a continuous LED indicates a successful connection. Spektrum or E-flite 2S batteries with a PH plug require an adapter lead. (SPMXCA327).

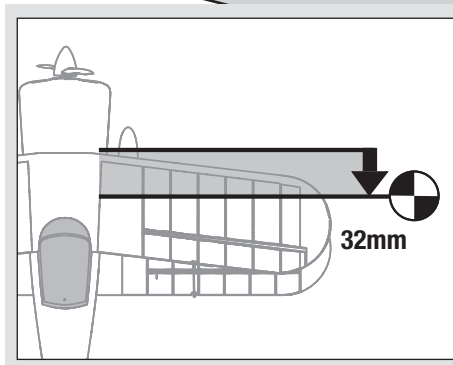

CAUTION: Always disconnect the Li-Po battery from the ESC when not flying to eliminate power supplied to the motor. The ESC does not have an arming switch and will respond to any transmitter input when a signal is present.

CAUTION: Always disconnect the Li-Po battery from the ESC when not flying to avoid over-discharging the battery. Batteries discharged to a voltage lower than the lowest approved voltage may become damaged, resulting in loss of performance and potential fire when batteries are charged.

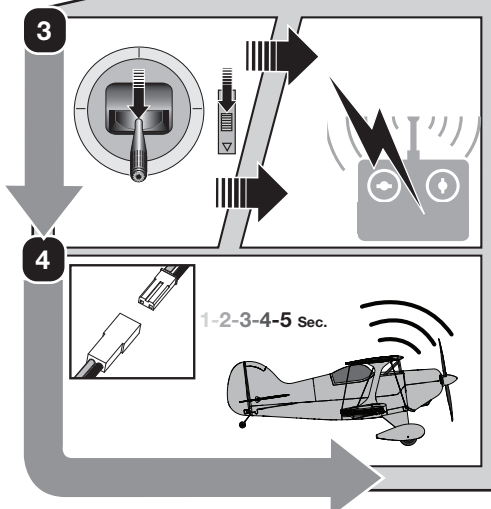







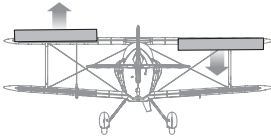

Control Direction Tests

Traditional Control Direction Test

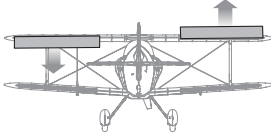
You should bind your aircraft and transmitter before doing these tests. Move the controls on the transmitter to make sure the aircraft control surfaces move correctly and in the proper direction. Make sure the tail linkages move freely and that paint or decals are not adhered to them.

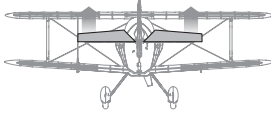
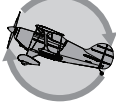
AS3X® Control Direction Test

This test ensures that the AS3X® control system is functioning properly.

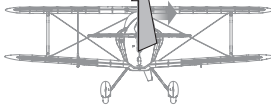
		Aircraft Movement	AS3X Reaction
Aileron	1. Advance the throttle above 25% to activate the AS3X system. 2. Fully lower the throttle. 3. Move the entire aircraft as shown and ensure the control surfaces move in the direction indicated in the graphic. If the control surfaces do not respond as shown, do not fly the aircraft. Refer to the receiver manual for more information.		
	Once the AS3X system is active, control surfaces may move rapidly. This is normal. AS3X is active until the battery is disconnected.		
Elevator			
			
Rudder			
			

Control Centering

Before the first flights, or in the event of an accident, make sure the flight control surfaces are centered.

Adjust the linkages mechanically if the control surfaces are not centered. Use of the transmitter sub-trims may not correctly center the aircraft control surfaces due to the mechanical limits of linear servos.

1. Make sure the control surfaces are neutral when the transmitter controls and trims are entered. The transmitter sub-trim must always be set to zero.
2. When needed, use a pair of pliers to carefully bend the metal linkage (see illustration).
3. Make the U-shape narrower to make the linkage shorter. Make the U-shape wider to make the linkage longer.

Centering Controls After First Flights

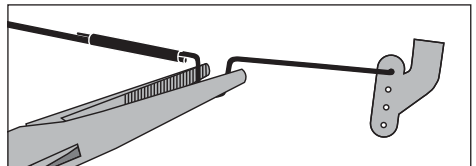

For best performance with AS3X, it is important that excessive trim is not used. If the aircraft requires excessive transmitter trim (4 or more clicks of trim per channel), return the transmitter trim to zero and adjust the linkages mechanically so that the control surfaces are in the flight trimmed position.

Control Horn Settings

The illustration shows the factory settings for the control horns. Fly the aircraft at factory settings before making changes.

After flying, you may choose to adjust the linkage positions for the desired control response.



CAUTION: When these are incorrectly connected for the pilot's skill level, unexpected aircraft response to controls can result. This can cause damage to the aircraft and personal injury.

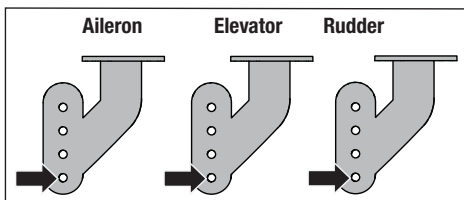

Flying Tips and Repairs

We recommend flying your aircraft outside in calm conditions. Always avoid flying near houses, trees, wires and buildings. You should also be careful to avoid flying in areas where there are many people, such as busy parks, schoolyards or soccer fields. Consult local laws and ordinances before choosing a location to fly your aircraft.

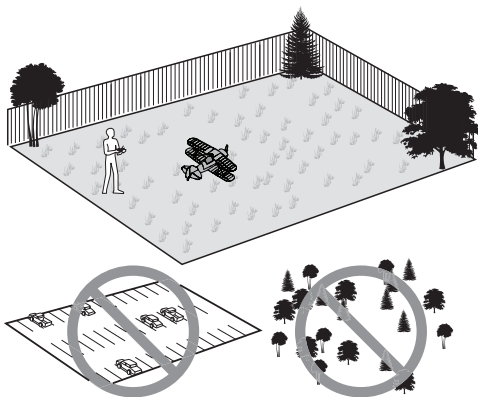

Takeoff

Place the aircraft in position for takeoff (facing into the wind if flying outdoors). Set dual rates to low position and gradually increase the throttle to $\frac{3}{4}$ to full and steer with the rudder. Pull back gently on the elevator and climb to check trim. Once the trim is adjusted, begin exploring the flight envelope of the aircraft.

Landing

Land into the wind. This is very important for this model. Fly the aircraft to approximately 6 inches (15cm) or less above the runway, using a small amount of throttle for the entire descent. Keep the throttle on until the aircraft

is ready to flare. During flare, keep the wings level and the airplane pointed into the wind. Gently lower the throttle while pulling back on the elevator to bring the aircraft down on all three wheels.

Failure to lower the throttle stick and trim to the lowest possible positions during a crash could result in damage to the ESC in the receiver unit, which may require replacement.

This aircraft is equipped with Over Current Protection (OCP). This feature protects the ESC from overheating. OCP stops the motor when the transmitter throttle is set too high and the propeller cannot turn. The OCP will only activate when the throttle stick is positioned just above $\frac{1}{2}$ throttle. After the ESC stops the motor, fully lower the throttle to re-arm the ESC.

NOTICE: Crash damage is not covered under the warranty.

Repairs

Repair the aircraft using foam-compatible CA (cyanoacrylate adhesive) or clear tape. **Only use foam-compatible CA**, as other types of glue can damage the foam. When parts are not repairable, see the Replacement Parts List for ordering by item number.

For a listing of all replacement and optional parts, refer to the list at the end of this manual.

NOTICE: Use of foam-compatible CA accelerant on your aircraft can damage paint. DO NOT handle the aircraft until the accelerant fully dries.

NOTICE: When you are finished flying, never leave the aircraft in direct sunlight or in a hot, enclosed area such as a car. Doing so can damage the foam.

CAUTION



Always decrease throttle at propeller strike.

Post Flight Checklist

✓	
	1. Disconnect the flight battery from the ESC (Required for safety and battery life).
	2. Power OFF the transmitter.
	3. Remove the flight battery from the aircraft.
	4. Recharge the flight battery.

✓	
	5. Store the flight battery apart from the aircraft and monitor the battery charge.
	6. Make note of the flight conditions and flight plan results, planning for future flights.

Power Components Service

Disassembly



CAUTION: DO NOT handle the propeller while the flight battery is connected to the ESC. Personal injury could result.

Propeller

- Remove the spinner (A) from the propeller.
Since the propeller and spinner are glued together, glue residue will need to be cleaned from the spinner or propeller when these parts are used again.
- Carefully remove the screw (B) and propeller (C) from the motor shaft.

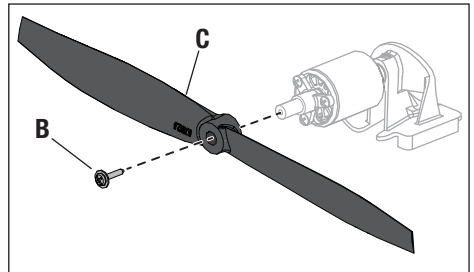
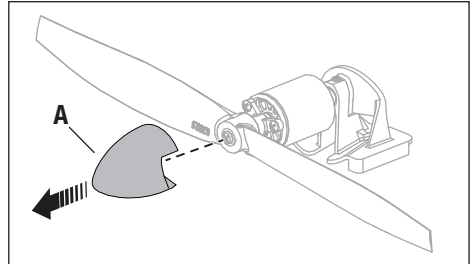

Motor

- Remove the battery hatch by gripping the front of the hatch, then pulling it up and away from the fuselage.
- Disconnect the motor wire connector from the ESC/receiver connector.
- Remove the screw (D) and motor (E) from the motor mount.
- Remove 3 screws (F) and the prop adapter (G) from the motor. The motor magnet may attract screws to the motor.

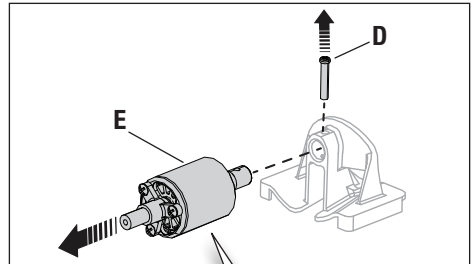

Assembly

Assemble in reverse order.

- Connect the motor wire connector to the ESC/receiver.
- The propeller size numbers (5.3 x 3.5) must face forward for correct propeller operation.
- Ensure the propeller adapter and motor mount are fully connected to the motor.

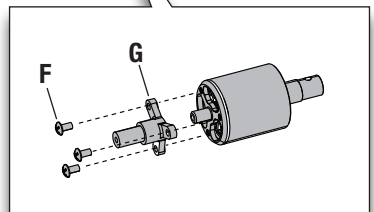

AS3X® System Trouble Shooting Guide

Problem	Possible Cause	Solution
Control surfaces not at neutral position when transmitter controls are at neutral	Control surfaces may not have been mechanically centered from factory	Center control surfaces mechanically by adjusting the U-bends on control linkages
	Aircraft was moved after the flight battery was connected and before sensors initialized	Disconnect and reconnect the flight battery while keeping the aircraft still for 5 seconds
Model flies inconsistently from flight to flight	Aircraft was not kept immobile for 5 seconds after battery was plugged in	Keep the aircraft immobile for 5 seconds after plugging in the battery
	Trims are moved too far from neutral position	Neutralize trims and mechanically adjust linkages to center control surfaces
Controls oscillate in flight, (model rapidly jumps or moves)	Propeller is unbalanced, causing excessive vibration	Remove propeller and rebalance or replace it if damaged
	Prop screw is too loose, causing vibration	Tighten the prop screw

Troubleshooting Guide

Problem	Possible Cause	Solution
Aircraft will not respond to throttle but responds to other controls	Throttle stick and/or throttle trim too high	Reset controls with throttle stick and throttle trim at lowest setting
	Throttle channel is reversed	Reverse throttle channel on transmitter
	Motor disconnected from receiver	Open fuselage and make sure motor is connected to the receiver
Extra propeller noise or extra vibration	Damaged propeller, spinner or motor	Replace damaged parts
	Prop screw is too loose	Tighten the prop screw
	Prop is out of balance	Remove and balance propeller, or replace with a balanced propeller
Reduced flight time or aircraft underpowered	Flight battery charge is low	Completely recharge flight battery
	Propeller installed backwards	Install propeller with numbers facing forward
	Flight battery damaged	Replace flight battery and follow flight battery instructions
	Flight conditions may be too cold	Make sure battery is warm before use
	Battery capacity too low for flight conditions	Replace battery or use a larger capacity battery
LED on receiver flashes and aircraft will not bind to transmitter (during binding)	Transmitter too near aircraft during binding process	Power off transmitter, move transmitter a larger distance from aircraft, disconnect and reconnect flight battery to aircraft and follow binding instructions
	Bind switch or button not held long enough during bind process	Power off transmitter and repeat bind process. Hold transmitter bind button or switch until receiver is bound
	Aircraft or transmitter is too close to large metal object, wireless source or another transmitter	Move aircraft and transmitter to another location and attempt binding again

Troubleshooting Guide

Problem	Possible Cause	Solution
LED on receiver flashes rapidly and aircraft will not respond to transmitter (after binding)	Less than a 5-second wait between first powering on transmitter and connecting flight battery to aircraft	Leaving transmitter on, disconnect and reconnect flight battery to aircraft
	Aircraft bound to different model memory (ModeIMatch™ radios only)	Select correct model memory on transmitter and disconnect and reconnect flight battery to aircraft
	Flight battery/transmitter battery charge is too low	Replace/recharge batteries
	Transmitter may have been bound to a different model (or with a different DSM Protocol)	Select the right transmitter or bind to the new one
	Aircraft or transmitter is too close to large metal object, wireless source or another transmitter	Move aircraft and transmitter to another location and attempt linking again
Control surface does not move	Control surface, control horn, linkage or servo damage	Replace or repair damaged parts and adjust controls
	Wire damaged or connections loose	Do a check of wires and connections, connect or replace as needed
	Flight battery charge is low	Fully recharge flight battery
	Control linkage does not move freely	Make sure control linkage moves freely
Controls reversed	Transmitter settings reversed	Adjust controls on transmitter appropriately
Motor loses power	Damage to motor or power components	Do a check of motor and power components for damage (replace as needed)
Motor power quickly decreases and increases then motor loses power	Battery power is down to the point of receiver/ESC Low Voltage Cutoff (LVC)	Recharge flight battery or replace battery that is no longer performing
Motor/ESC is not armed after landing	Over Current Protection (OCP) stops the motor when the transmitter throttle is set high and the propeller cannot turn	Fully lower throttle and throttle trim to arm ESC
Servo locks or freezes at full travel	Travel adjust value is set above 100%, overdriving the servo	Set Travel adjust to 100% or less and/or set sub-trims to Zero and adjust linkages mechanically

Replacement Parts

Part #	Description
EFLU15030	Motor Mount
EFLU15246	Pushrod/Wing Brace Set
EFLU15251	Spinner Set (3)
EFLU15255	Landing Gear Set w/ Wheel Pants
EFLU15258	Fuselage w/Cabane and Hatch
EFLU15259	Wing Set
EFLU15260	Tail Set w/ Accessories
EFLU15261	Interplane Struts
EFLU15262	Battery Hatch
EFLU15265	Decal Set
EFLU15267	Propeller Adapter
EFLU15270	Ultra Micro 1/14 Scale Aerobatic Pilot
EFLUP113589	5.3 x 3.5 Propeller
SPMXAM1208	Brushless Outrunner Motor, 1900Kv, 10-Pole
SPMA3187	Receiver / ESC
SPMR6775	NX6 DSMX 6-Channel Transmitter
SPMX3003SJ30	300mAh 3S Li-Po Battery with JST Connector
SPMXC1070	S150 AC/DC Smart Charger, 1x50W
SPMXCA310	Adapter: IC3 Battery / JST Device

Optional Parts and Accessories

Part #	Description
EFLA700UM	Charger Plug Adapter
EFLB2002S25	2S 7.4V 200mAh 25C Li-Po Battery
EFLB2002S30	2S 7.4V 200mAh 30C C Battery
EFLB2802S30	7.4V 280mAh 2S 30C Li-Po Battery with PH Connector
EFLB3003SJ30	300mAh 3S 30C Li-Po Battery with JST Connector
PKZ1039	Hook and Loop Set (5): Ultra Micros
SPMR8105	DX8e DSMX 8-Channel Transmitter
SPMR6775	NX6 DSMX 6-Channel Transmitter
SPMR8200	NX8 DSMX 8-Channel Transmitter
SPMX3002S30	300mAh 2S Li-Po Battery with PH Connector
SPMX3003SJ30	300mAh 3S Li-Po Battery with JST Connector
SPMXC1070	S150 AC/DC Smart Charger, 1x50W
SPMXCA310	Adapter: IC3 Battery / JST Device
SPMXCA327	Adapter: PH to JST Connector

Important Federal Aviation Administration (FAA) Information

Use the QR code below to learn more about the **Recreational UAS Safety Test (TRUST)**, as was introduced by the 2018 FAA Reauthorization Bill. This free test is required by the FAA for all recreational flyers in the United States. The completed certificate must be presented upon request by any FAA or law enforcement official.



If your model aircraft weighs more than .55lbs or 250 grams, you are required by the FAA to register as a recreational flyer and apply your registration number to the outside of your aircraft. To learn more about registering with the FAA, use the QR code below.



AMA National Model Aircraft Safety Code

Effective January 1, 2018

A model aircraft is a non-human-carrying device capable of sustained flight within visual line of sight of the pilot or spotter(s). It may not exceed limitations of this code and is intended exclusively for sport, recreation, education and/or competition. All model flights must be conducted in accordance with this safety code and related AMA guidelines, any additional rules specific to the flying site, as well as all applicable laws and regulations.

As an AMA member I agree:

- I will not fly a model aircraft in a careless or reckless manner.
- I will not interfere with and will yield the right of way to all human-carrying aircraft using AMA's See and Avoid Guidance and a spotter when appropriate.
- I will not operate any model aircraft while I am under the influence of alcohol or any drug that could adversely affect my ability to safely control the model.
- I will avoid flying directly over unprotected people, moving vehicles, and occupied structures.
- I will fly Free Flight (FF) and Control Line (CL) models in compliance with AMA's safety programming.
- I will maintain visual contact of an RC model aircraft without enhancement other than corrective lenses prescribed to me. When using an advanced flight system, such as an autopilot, or flying First-Person View (FPV), I will comply with AMA's Advanced Flight System programming.
- I will only fly models weighing more than 55 pounds, including fuel, if certified through AMA's Large Model Airplane Program.
- I will only fly a turbine-powered model aircraft in compliance with AMA's Gas Turbine Program.
- I will not fly a powered model outdoors closer than 25 feet to any individual, except for myself or my helper(s) located at the flightline, unless I am taking off and landing, or as otherwise provided in AMA's Competition Regulation.
- I will use an established safety line to separate all model aircraft operations from spectators and bystanders.

Limited Warranty

What this Warranty Covers—Horizon Hobby, LLC, (Horizon) warrants to the original purchaser that the product purchased (the "Product") will be free from defects in materials and workmanship at the date of purchase.

What is Not Covered—This warranty is not transferable and does not cover (i) cosmetic damage, (ii) damage due to acts of God, accident, misuse, abuse, negligence, commercial use, or due to improper use, installation, operation or maintenance, (iii) modification of or to any part of the Product, (iv) attempted service by anyone other than a Horizon Hobby authorized service center, (v) Product not purchased from an authorized Horizon dealer, (vi) Product not compliant with applicable technical regulations, or (vii) use that violates any applicable laws, rules, or regulations.

OTHER THAN THE EXPRESS WARRANTY ABOVE, HORIZON MAKES NO OTHER WARRANTY OR REPRESENTATION, AND HEREBY DISCLAIMS ANY AND ALL IMPLIED WARRANTIES, INCLUDING, WITHOUT LIMITATION, THE IMPLIED WARRANTIES OF NON-INFRINGEMENT, MERCHANTABILITY AND FITNESS

FOR A PARTICULAR PURPOSE. THE PURCHASER ACKNOWLEDGES THAT THEY ALONE HAVE DETERMINED THAT THE PRODUCT WILL SUITABLY MEET THE REQUIREMENTS OF THE PURCHASER'S INTENDED USE.

Purchaser's Remedy—Horizon's sole obligation and purchaser's sole and exclusive remedy shall be that Horizon will, at its option, either (i) service, or (ii) replace, any Product determined by Horizon to be defective. Horizon reserves the right to inspect any and all Product(s) involved in a warranty claim. Service or replacement decisions are at the sole discretion of Horizon. Proof of purchase is required for all warranty claims. SERVICE OR REPLACEMENT AS PROVIDED UNDER THIS WARRANTY IS THE PURCHASER'S SOLE AND EXCLUSIVE REMEDY.

Limitation of Liability—HORIZON SHALL NOT BE LIABLE FOR SPECIAL, INDIRECT, INCIDENTAL OR CONSEQUENTIAL DAMAGES, LOSS OF PROFITS OR PRODUCTION OR COMMERCIAL LOSS IN ANY WAY, REGARDLESS OF WHETHER SUCH CLAIM IS BASED IN CONTRACT, WARRANTY, TORT,

NEGLIGENCE, STRICT LIABILITY OR ANY OTHER THEORY OF LIABILITY, EVEN IF HORIZON HAS BEEN ADVISED OF THE POSSIBILITY OF SUCH DAMAGES. Further, in no event shall the liability of Horizon exceed the individual price of the Product on which liability is asserted. As Horizon has no control over use, setup, final assembly, modification or misuse, no liability shall be assumed nor accepted for any resulting damage or injury. By the act of use, setup or assembly, the user accepts all resulting liability. If you as the purchaser or user are not prepared to accept the liability associated with the use of the Product, purchaser is advised to return the Product immediately in new and unused condition to the place of purchase.

Law—These terms are governed by Illinois law (without regard to conflict of law principals). This warranty gives you specific legal rights, and you may also have other rights which vary from state to state. Horizon reserves the right to change or modify this warranty at any time without notice.

WARRANTY SERVICES

Questions, Assistance, and Services—Your local hobby store and/or place of purchase cannot provide warranty support or service. Once assembly, setup or use of the Product has been started, you must contact your local distributor or Horizon directly. This will enable Horizon to better answer your questions and service you in the event that you may need any assistance. For questions or assistance, please visit our website at www.horizonhobby.com, submit a Product Support Inquiry, or call the toll free telephone number referenced in the Warranty and Service Contact Information section to speak with a Product Support representative.

Inspection or Services—If this Product needs to be inspected or serviced and is compliant in the country you live and use the Product in, please use the Horizon Online Service Request submission process found on our website or call Horizon to obtain a Return Merchandise Authorization (RMA) number. Pack the Product securely using a shipping carton. Please note that original boxes may be included, but are not designed to withstand the rigors of shipping without additional protection. Ship via a carrier that provides tracking and insurance for lost or damaged parcels, as Horizon is not responsible for merchandise until it arrives and is accepted at our facility. An Online Service Request is available at http://www.horizonhobby.com/content/service-center_render-service-center. If you do not have internet access, please contact Horizon Prod-

uct Support to obtain a RMA number along with instructions for submitting your product for service. When calling Horizon, you will be asked to provide your complete name, street address, email address and phone number where you can be reached during business hours. When sending product into Horizon, please include your RMA number, a list of the included items, and a brief summary of the problem. A copy of your original sales receipt must be included for warranty consideration. Be sure your name, address, and RMA number are clearly written on the outside of the shipping carton.

NOTICE: Do not ship LiPo batteries to Horizon. If you have any issue with a LiPo battery, please contact the appropriate Horizon Product Support office.

Warranty Requirements—For Warranty consideration, you must include your original sales receipt verifying the proof-of-purchase date. Provided warranty conditions have been met, your Product will be serviced or replaced free of charge. Service or replacement decisions are at the sole discretion of Horizon.

Non-Warranty Service—Should your service not be covered by warranty, service will be completed and payment will be required without notification or estimate of the expense unless the expense exceeds 50% of the retail purchase cost. By submitting the item for service you are agreeing to payment of the service without notification. Service estimates are available upon request. You must include this request with your item submitted for service. Non-warranty service estimates will be billed a minimum of ½ hour of labor. In addition you will be billed for return freight. Horizon accepts money orders and cashier's checks, as well as Visa, MasterCard, American Express, and Discover cards. By submitting any item to Horizon for service, you are agreeing to Horizon's Terms and Conditions found on our website http://www.horizonhobby.com/content/service-center_render-service-center.

ATTENTION: Horizon service is limited to Product compliant in the country of use and ownership. If received, a non-compliant Product will not be serviced. Further, the sender will be responsible for arranging return shipment of the un-serviced Product, through a carrier of the sender's choice and at the sender's expense. Horizon will hold non-compliant Product for a period of 60 days from notification, after which it will be discarded.

10/15

Contact Information

Country of Purchase	Horizon Hobby	Contact Information	Address
United States of America	Horizon Service Center (Repairs and Repair Requests)	servicecenter.horizonhobby.com/Request-Form/	2904 Research Rd Champaign, Illinois, 61822 USA
	Horizon Product Support (Product Technical Assistance)	productsupport@horizonhobby.com 877-504-0233	
	Sales	websales@horizonhobby.com 800-338-4639	
European Union	Horizon Technischer Service Sales: Horizon Hobby GmbH	service@horizonhobby.eu +49 (0) 4121 2655 100	Hanskamping 9 D 22885 Barsbüttel, Germany

FCC Information



Contains FCC ID: BRWWAC01T

This equipment complies with FCC and IC radiation exposure limits set forth for an uncontrolled environment. This equipment should be installed and operated with minimum distance 20cm between the radiator and/or antenna and your body (excluding fingers, hands, wrists, ankles and feet). This transmitter must not be co-located or operating in conjunction with any other antenna or transmitter.

Supplier's Declaration of Conformity EFL UMX Pitts BNF Basic (EFLU15250)

This device complies with part 15 of the FCC Rules. Operation is subject to the following two conditions: (1) This device may not cause harmful interference, and (2) this device must accept any interference received, including interference that may cause undesired operation.



CAUTION: Changes or modifications not expressly approved by the party responsible for compliance could void the user's authority to operate the equipment.

NOTE: This equipment has been tested and found to comply with the limits for a Class B digital device, pursuant to part 15 of the FCC Rules. These limits are designed to provide reasonable protection against harmful interference in a

residential installation. This equipment generates, uses and can radiate radio frequency energy and, if not installed and used in accordance with the instructions, may cause harmful interference to radio communications. However, there is no guarantee that interference will not occur in a particular installation. If this equipment does cause harmful interference to radio or television reception, which can be determined by turning the equipment off and on, the user is encouraged to try to correct the interference by one or more of the following measures:

- Reorient or relocate the receiving antenna.
- Increase the separation between the equipment and receiver.
- Connect the equipment into an outlet on a circuit different from that to which the receiver is connected.
- Consult the dealer or an experienced radio/TV technician for help.

Horizon Hobby, LLC
2904 Research Rd.
Champaign, IL 61822
Email: compliance@horizonhobby.com
Web: HorizonHobby.com

IC Information

CAN ICES-3 (B)/NMB-3(B)

Contains IC: 6157A-WAC01T

This device contains license-exempt transmitter(s)/receivers(s) that comply with Innovation, Science, and Economic Development Canada's license-exempt RSS(s). Operation is subject to the following 2 conditions:

1. This device may not cause interference.
2. This device must accept any interference, including interference that may cause undesired operation of the device.

Compliance Information for the European Union



EU Compliance Statement: EFL UMX Pitts BNF Basic (EFLU5250):

Hereby, Horizon Hobby, LLC declares that the device is in compliance with the following: EU

Radio Equipment Directive 2014/53/EU, RoHS 2 Directive 2011/65/EU, RoHS 3 Directive - Amending 2011/65/EU Annex II 2015/863.

The full text of the EU declaration of conformity is available at the following internet address: <https://www.horizonhobby.com/content/support-render-compliance>.

Receiver:
2404-2476MHz
1.43dBm

EU Manufacturer of Record:

Horizon Hobby, LLC
2904 Research Road
Champaign, IL 61822 USA

EU Importer of Record:

Horizon Hobby, GmbH
Hanskampring 9
22885 Barsbüttel Germany

WEEE NOTICE:



This appliance is labeled in accordance with European Directive 2012/19/EU concerning waste of electrical and electronic equipment (WEEE). This label indicates that this product should not be disposed of with household waste. It should be deposited at an appropriate facility to enable recovery and recycling.



E328



©2021 Horizon Hobby, LLC.

E-flite, AS3X, Blade, Celectra, UMX, DSM, DSM2, DSMX, ModelMatch, Bind-N-Fly, the Bind-N-Fly logo and the Horizon Hobby logo are trademarks or registered trademarks of Horizon Hobby, LLC.

The Spektrum trademark is used with permission of Bachmann Industries, Inc.

Aviat®, Aviat Aircraft™ and Pitts® are trademarks or registered trademarks of Aviat Aircraft, Inc. and are used under license by Horizon Hobby, LLC.

All other trademarks, service marks and logos are property of their respective owners.

US 8,672,726 US 9,056,667 US 9,753,457. US 10,078,329. US 9,930,567. US 10,419,970. Other patents pending.

<http://www.horizonhobby.com/>