

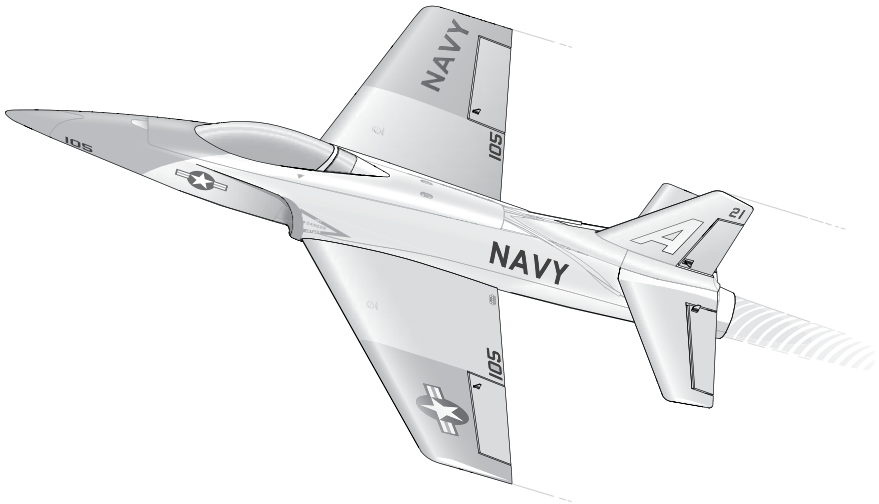

Bind-N-Fly.™ Ready to fly, redefined.

UMX™ Habu S DF180



*Instruction Manual
Bedienungsanleitung
Manuel d'utilisation
Manuale di Istruzioni*



SAFE™

E-flite®
ADVANCING ELECTRIC FLIGHT

NOTICE

All instructions, warranties and other collateral documents are subject to change at the sole discretion of Horizon Hobby, LLC. For up-to-date product literature, visit www.horizonhobby.com and click on the support tab for this product.

Meaning of Special Language:

The following terms are used throughout the product literature to indicate various levels of potential harm when operating this product:

NOTICE: Procedures, which if not properly followed, create a possibility of physical property damage AND little or no possibility of injury.

CAUTION: Procedures, which if not properly followed, create the probability of physical property damage AND a possibility of serious injury.

WARNING: Procedures, which if not properly followed, create the probability of property damage, collateral damage, and serious injury OR create a high probability of superficial injury.



WARNING: Read the ENTIRE instruction manual to become familiar with the features of the product before operating. Failure to operate the product correctly can result in damage to the product, personal property and cause serious injury.

This is a sophisticated hobby product. It must be operated with caution and common sense and requires some basic mechanical ability. Failure to operate this product in a safe and responsible manner could result in injury or damage to the product or other property. This product is not intended for use by children without direct adult supervision. Do not use with incompatible components or alter this product in any way outside of the instructions provided by Horizon Hobby, LLC. This manual contains instructions for safety, operation and maintenance. It is essential to read and follow all the instructions and warnings in the manual, prior to assembly, setup or use, in order to operate correctly and avoid damage or serious injury.

Age Recommendation: Not for children under 14 years. This is not a toy.

Safety Precautions and Warnings

- Always keep a safe distance in all directions around your model to avoid collisions or injury. This model is controlled by a radio signal subject to interference from many sources outside your control. Interference can cause momentary loss of control.
- Always operate your model in open spaces away from full-size vehicles, traffic and people.
- Always carefully follow the directions and warnings for this and any optional support equipment (chargers, rechargeable battery packs, etc.).
- Always keep all chemicals, small parts and anything electrical out of the reach of children.
- Always avoid water exposure to all equipment not specifically designed and protected for this purpose. Moisture causes damage to electronics.
- Never place any portion of the model in your mouth as it could cause serious injury or even death.
- Never operate your model with low transmitter batteries.
- Always keep aircraft in sight and under control.
- Always use fully charged batteries.
- Always keep the transmitter powered on while aircraft is powered.
- Always remove batteries before disassembly.
- Always keep moving parts clean.
- Always keep parts dry.
- Always let parts cool after use before touching.
- Always remove batteries after use.
- Always ensure failsafe is properly set before flying.
- Never operate aircraft with damaged wiring.
- Never touch moving parts.



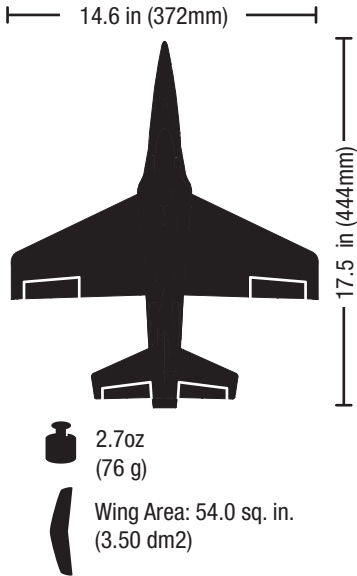

Table of Contents

SAFE™ Transmitter Setup	4	Factory Control Horn Settings.....	12
SAFE™ Technology Flight Modes	5	Landing Gear Removal	12
Charger Warnings	6	Post Flight Checklist	12
Battery Charging.....	6	Troubleshooting Guide	13
Transmitter and Receiver Binding.....	7	Troubleshooting Guide (Continued).....	14
ESC/Receiver Arming, Battery Installation and		Limited Warranty	14
Center of Gravity.....	8	Warranty and Service Contact Information	16
Control Centering	9	IC Information.....	16
Control Direction Tests	9	FCC Information.....	16
Dual Rates and Expos	10	Compliance Information for the European Union..	16
DX4e and DX5e Expo Activation and Deactivation	10	Replacement Part	64
Flying Tips and Repairs	11	Optional Parts and Accessories	65



Specifications



Installed

-  **Motor:** BL180m Ducted Fan Motor, 11750Kv (EFLM30180mDFB)
-  **Ducted Fan Unit:** Delta-V® 180m 28mm EDF Unit (EFLDF180m)
-  **Receiver:** Spektrum™ DSMX® 6Ch SAFE™ Receiver w/BL ESC (SPMA3165)
-  **Servo:** (4) 2.3-Gram Performance Linear Long Throw Servo (SPMSA2030L)

Included

-  **Battery:** 200mAh 2S 25C Li-Po (EFLB2002S25)
-  **Battery Charger:** 2S 7.4V Li-Po (EFLUC10007)

Needed to Complete

-  **Recommended Transmitter:** Spektrum™ DSM2®/DSMX® full range with dual-rates (DX4e and up)

Preflight Checklist

✓	
	1. Set up your transmitter to support SAFE technology.
	2. Charge flight battery.
	3. Install flight battery in aircraft (once it has been fully charged).
	4. Bind aircraft to transmitter.
	5. Make sure linkages move freely.

✓	
	6. Perform Control Direction Test with transmitter.
	7. Set dual rates and expos.
	8. Adjust center of gravity.
	9. Perform a radio system Range Check.
	10. Find a safe and open area.
	11. Plan flight for flying field conditions.

SAFE™ Transmitter Setup

Your DSM2/DSMX transmitter will need to be configured using the provide transmitter setup chart in order to experience all the features and benefits of the receiver with SAFE™ in this aircraft.

Quick Overview

- SAFE Flight mode is selected using Channel 5 signal (high, middle, low).
- Panic mode is selected with Channel 6 signal (high, low). Refer to your transmitter's manual for detailed information on how to navigate through your transmitter settings.

IMPORTANT: A transmitter with a 2-position channel 5 switch will only allow the use of position 0 or position 2 flight modes.

Computerized Transmitter Setup (DX6i, DX6, DX7S, DX8, DX9, DX10t and DX18)	
Start all transmitter programming with a blank ACRO model (do a model reset), then name the model.	
Set Dual Rates to:	HIGH 100% LOW 70%
Set Servo Travel to:	100%
DX6i	1. Go to the SETUP LIST MENU
	2. Set MODEL TYPE: ACRO
	3. Set REVERSE: Gear Channel
	4. Go to ADJUST LIST MENU
	5. Set TRAVEL ADJ: Gear/Fmode (0) ↑100%, Gear/Fmode (1) ↓40%
	6. Set FLAPS: Norm ↑100, LAND ↓100
	7. Set MIX 1: ACT; Gear →Gear ACT, RATE D 0%; U + 100%, SW MIX, TRIM INH
Resulting in:	The Gear and Mix switches operate the 3 SAFE modes. Gear 0; Mix 0 = Beginner Mode Gear 1; Mix 0 = Intermediate Mode Gear 1; Mix 1 = Experienced Mode The Flap switch operates Panic Recovery: Position 0=Off Position 1=On. (not a momentary switch)
DX7S DX8	1. Go to the SYSTEM SETUP
	2. Set MODEL TYPE: AIRPLANE
	3. Set SWITCH SELECT: Change all to INH: Then TRAINER: AUX1 Then FLAP: GEAR
	4. Go to the FUNCTION LIST
	5. Set SERVO SETUP: Reverse AUX1
	Resulting in:
DX6 DX9 DX10t DX18	1. Go to the SYSTEM SETUP
	2. Set MODEL TYPE: AIRPLANE
	3. Set WING TYPE: NORMAL
	4. Go to CHANNEL ASSIGN: Channel Input Config: Set GEAR: D (DX10t: GEAR: A) Set AUX1: I (DX10t: AUX1: R-TIP)
	5. Go to the FUNCTION LIST
	6. Set SERVO SETUP: Reverse AUX1
	Resulting in:
IMPORTANT: After you set up your model, always rebind the transmitter and receiver to set the desired failsafe positions.	

SAFE™ Technology Flight Modes

The installed receiver has been programmed for operation in only this aircraft, providing the following selectable flight modes.

Beginner Mode:







Pitch (nose up and down) and Roll (wing tips up and down) angles are limited to help you keep the aircraft airborne. Release both sticks for self-leveling.

Intermediate Mode:

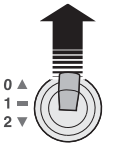
Same as beginner mode, but with a wider flight envelope and without self-leveling.

Experienced Mode:

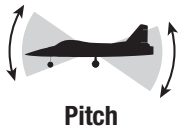
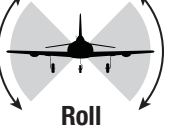
Unlimited flight envelope with AS3X® stabilization.

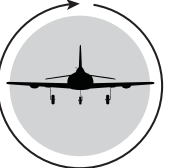
Flight Mode Switch	SAFE™ Flight Modes	
Beginner Mode		
	 <p>Pitch</p>	 <p>Roll</p>
Intermediate Mode		
	 <p>Pitch</p>	 <p>Roll</p>
Experienced Mode		
	 <p>Pitch</p>	 <p>Roll</p>

Panic Recovery Mode

- If you feel you have lost control in any mode, hold the Panic Recovery button. The SAFE technology will return the aircraft to upright flight.
- Always fly at a safe altitude, as Panic Recovery may cause the aircraft to lose altitude while returning to upright flight.
- Release the Panic Recovery button to turn off Panic mode and return to the current SAFE flight mode with full stick control again.

IMPORTANT: If the aircraft is upside down when the Panic Recovery button is pressed, sufficient altitude may be required for the aircraft to return to upright flight.

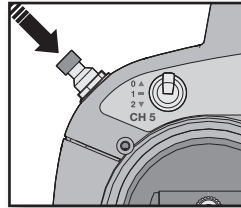

DX4e shown. Panic Button / Switch may vary depending on Transmitter model. See Transmitter setup more info.

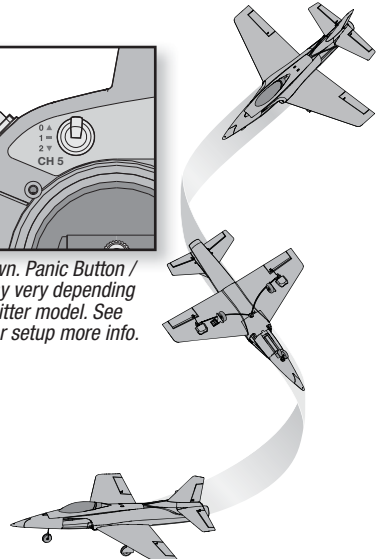

Charger Warnings

The battery charger (EFLUC1007) included with your aircraft has been designed to safely charge the Li-Po battery.

CAUTION: All instructions and warnings must be followed exactly. Mishandling of Li-Po batteries can result in a fire, personal injury and/or property damage.

- By handling, charging or using the included Li-Po battery, you assume all risks associated with lithium batteries.
- If at any time the battery begins to balloon or swell, discontinue use immediately. If charging or discharging, discontinue and disconnect. Continuing to use, charge or discharge a battery that is ballooning or swelling can result in fire.
- Always store the battery at room temperature in a dry area for best results.
- Always transport or temporarily store the battery in a temperature range of 40–120° F (5–49° C). Do not store the battery or model in a car or direct sunlight. If stored in a hot car, the battery can be damaged or even catch fire.
- Always charge batteries away from flammable materials.
- Always inspect the battery before charging.
- Always disconnect the battery after charging, and let the charger cool between charges.
- Always constantly monitor the temperature of the battery pack while charging.
- **ONLY USE A CHARGER SPECIFICALLY DESIGNED TO CHARGE LI-PO BATTERIES.** Failure to charge the battery with a compatible charger may cause a fire resulting in personal injury and/or property damage.
- Never discharge Li-Po cells to below 3V under load.
- Never cover warning labels with hook and loop strips.
- Never leave charging batteries unattended.
- Never charge batteries outside recommended levels.
- Never charge damaged batteries.
- Never attempt to dismantle or alter the charger.
- Never allow minors to charge battery packs.
- Never charge batteries in extremely hot or cold places (recommended between 40–120° F (5–49° C)) or place in direct sunlight.

Battery Charging

LED Indications

1. Green LED blinking Standby
2. Red LED blinking at varying speeds ... Charging
3. Red and Green LED blink in unison..... Balancing
4. Green solid LED Full Charge
5. Red and Green LED flashing rapidly ... Error

CAUTION: Never exceed the recommended charge rate.

CAUTION: Charge only batteries that are cool to the touch and are not damaged. Look at the battery to make sure it is not damaged e.g., swollen, bent, broken or punctured.

CAUTION: Always disconnect the flight battery from the charger immediately upon completion of charging.

Charging a fully discharged (not over-discharged) 200mAh battery takes approximately 40 minutes at the charger's 300mA charge rate.

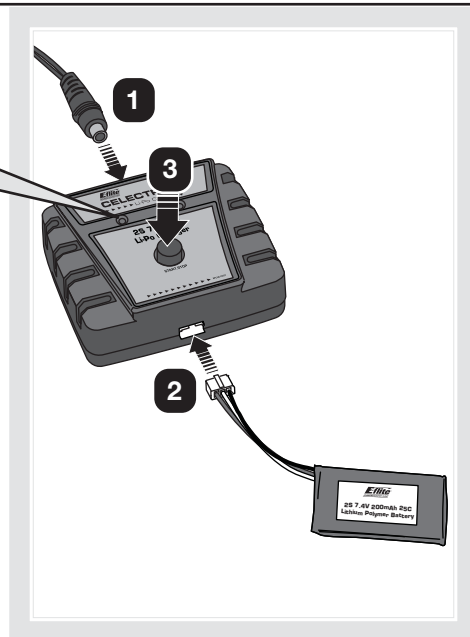

Transmitter and Receiver Binding

For a list of compatible DSM2/DSMX transmitters, please visit www.bindnfly.com

✓ Binding Procedure

⚠ CAUTION: When using a Futaba transmitter with a Spektrum DSM® module, you must reverse the throttle channel and rebind. Refer to your Spektrum module manual for binding and failsafe instructions. Refer to your Futaba transmitter manual for instructions on reversing the throttle channel.

- | | |
|--|--|
| | 1. Refer to your transmitter's unique instructions for binding to a receiver (location of transmitter's Bind control). |
| | 2. Make sure the flight battery is disconnected from the aircraft. |
| | 3. Ensure the transmitter is powered OFF. |
| | 4. Connect the flight battery to the aircraft and turn the aircraft upright. The receiver LED will begin to flash (typically after 5 seconds). |
| | 5. Ensure that control surface trims are centered and the throttle and throttle trims are in the low position to correctly set the failsafe. |
| | 6. Put your transmitter into bind mode. Refer to your transmitter's manual for binding button or switch instructions. |
| | 7. After 5 to 10 seconds, the receiver status LED will turn solid, indicating that the receiver is bound to the transmitter. If the LED does not turn solid, refer to the Troubleshooting Guide at the back of the manual. |

For subsequent flights, power ON the transmitter for 5 seconds before connecting the flight battery.

ESC/Receiver Arming, Battery Installation and Center of Gravity

NOTICE: Always keep material or debris away from the intake. When armed, the rotor will turn in response to throttle movement and could ingest in any loose objects.

Arming the ESC/receiver also occurs after binding as previously described, but subsequent connection of a flight battery requires the following steps.



The SAFE™ system will not activate until the throttle stick is increased for the first time. Once active, the control surfaces may move noisily on the aircraft. This is normal. SAFE™ technology will remain active until the battery is disconnected.

1. Lower the throttle and throttle trim to the lowest settings on your transmitter.
2. Attach the flight battery to the hook and loop strip (A) on the battery tray.

Center of Gravity (CG)

The CG location is 37mm back from the leading edge of the wing at the root. Adjust as needed by sliding the battery forward or back.

3. Power on your transmitter, then wait 5 seconds.
4. Connect the battery to the ESC, noting proper polarity. **Keep the plane upright, immobile and away from wind for 5 seconds to allow the SAFE™ system to initialize.** The aircraft will not initialize until the aircraft is still and upright.

A successful connection is indicated by:

- A series of tones
- A continuous LED

CAUTION: Always disconnect the Li-Po battery from the ESC when not flying to eliminate power supplied to the motor. The ESC does not have an arming switch and will respond to any transmitter input when a signal is present.

CAUTION: Always disconnect the Li-Po battery from the ESC when not flying to avoid over-discharging the battery. Batteries discharged to a voltage lower than the lowest approved voltage may become damaged, resulting in loss of performance and potential fire when batteries are recharged.

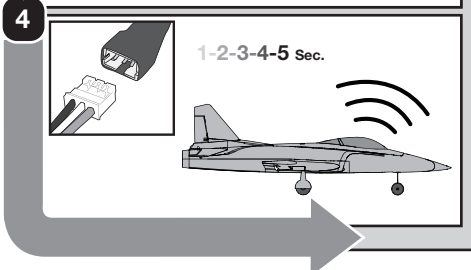
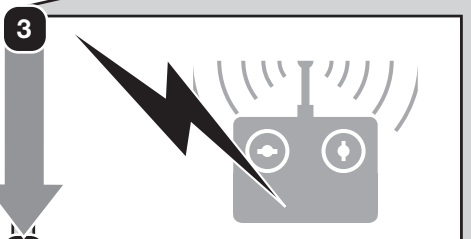
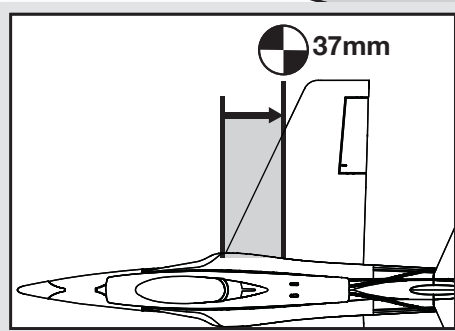
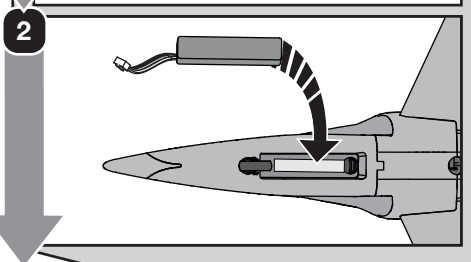
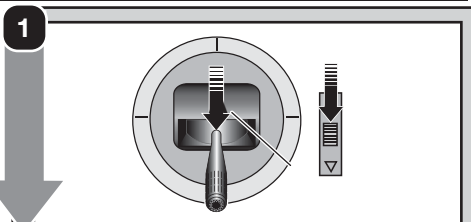

Control Centering

Before the first flights, or in the event of an accident, make sure control surfaces are centered when the transmitter controls and trims are neutral. The transmitter sub-trim must be set to zero. Adjust the linkages mechanically if the control surfaces are not centered. Use of the transmitter sub-trims may not correctly center the aircraft control surfaces due to the mechanical limits of linear servos.

- Make the U-shape narrower to make the connector shorter. Make the U-shape wider to make the linkage longer.

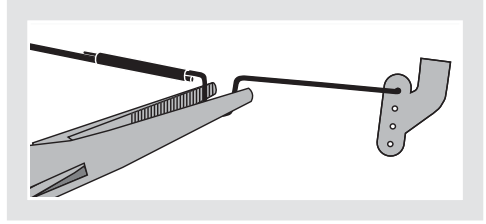

IMPORTANT: Only trim this aircraft in Experienced Flight Mode.

Control Direction Tests

You should bind your aircraft and transmitter before doing these tests.

Perform the Control Direction Test in Experienced Mode.

Move the controls on the transmitter to make sure the aircraft control surfaces move correctly and in the proper direction.

Make sure the tail linkages move freely and that paint or decals are not adhered to them.



Control Direction Test

This test ensures that the SAFE™ control system is functioning properly.

Assemble the aircraft and bind your transmitter to the receiver before performing this test.

1. Advance the throttle above 25% to activate the SAFE™ system.
2. Fully lower the throttle.
3. Move the entire aircraft as shown and ensure the control surfaces move in the direction indicated in the graphic. If the control surfaces do not respond as shown, do not fly the aircraft. Contact product support for more information.

Once the SAFE™ system is active, control surfaces may move rapidly. This is normal. SAFE is active until the battery is disconnected.

	Aircraft movement	SAFE Reaction
Elevator		
Aileron		
Rudder		

Dual Rates and Expos

To obtain the best flight performance, we recommend using a DSM2/DSMX radio capable of Dual Rates and Expo. The suggested settings shown here are the recommended starting settings. Adjust according to the individual preferences after the initial flight.

If using the DX4e or DX5e transmitters, we recommend activating Expo for smoother control. For activation and deactivation of Expo in the DX4e and DX5e, see the next section.

NOTICE: Do not set your transmitter travel adjust over 100%. If the TRAVEL ADJUST is set over 100%, it will not result in more control movement, it will overdrive the servo and cause damage.

It is normal for linear servos to make significant noise. The noise is not an indication of a faulty servo.

	Dual Rates		Expos	
	High	Low	High	Low
Aileron	100%	70%	10%	0%
Elevator	100%	70%	10%	0%
Rudder	100%	70%	10%	0%

Tip: For the first flight, fly the model in low rate.

Tip: For landing, we recommend using high rate elevator.

DX4e and DX5e Expo Activation and Deactivation

If you plan to fly your aircraft with a DX4e or DX5e, disconnect the battery from the aircraft before activating the Expo feature in your transmitter.

Once Expo is activated, it will remain activated for subsequent power cycles of the transmitter. Once Expo is deactivated, it will remain deactivated until it is activated again.

DX4e (Modes 1 and 2)

Activate and Deactivate Expo

- Put the ACT switch in the down position (ON) and the Rate switch in the down position (LO).
- Push and hold the trainer (bind) button and move and hold the two sticks (as shown here) for **activation (A)** or **deactivation (B)**, while powering on the transmitter.
- Release the trainer switch and the control sticks only after a series of tones sound (ascending tones for activation, descending tones for deactivation).

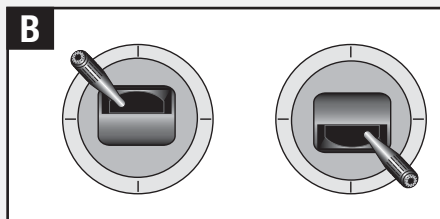
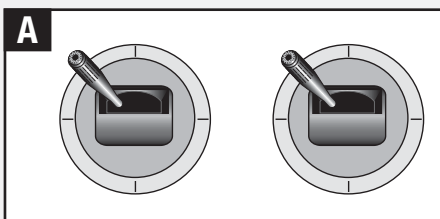

DX5e (Modes 1 and 2)

Activate and Deactivate Expo

- Hold the aileron trim switch to the **right for activation (C)** or to the **left for deactivation (D)**, while powering on the transmitter.
- Release the aileron trim switch after a series of tones sound, (ascending tones for activation, descending tones for deactivation).

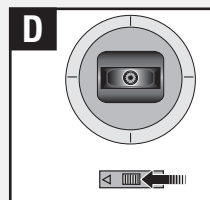
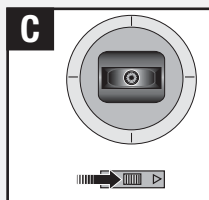

Flying Tips and Repairs

Range Check your Radio System

After final assembly, range check the radio system with the aircraft. Refer to your specific transmitter instruction manual for range test information.

Flying

We recommend flying your aircraft outside in no greater than moderate winds or inside in a very large indoor facility. Always avoid flying near houses, trees, wires and buildings. You should also be careful to avoid flying in areas where there are many people, such as busy parks, schoolyards or soccer fields. Consult local laws and ordinances before choosing a location to fly your aircraft.

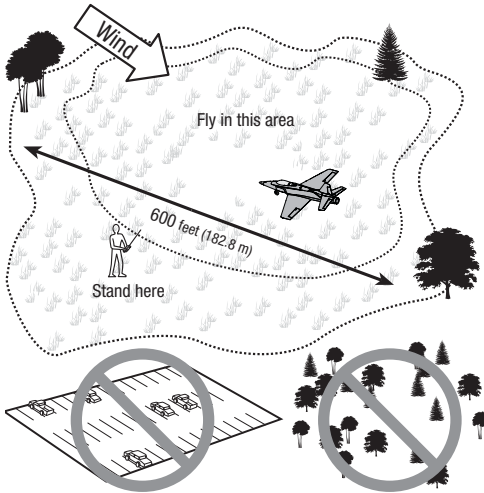

Hand Launching

Hold the aircraft under the wings. Give a firm throw directly into the wind slightly up (5–10 degrees above the horizon) with full throttle. After the model gains altitude, decrease the throttle as you desire.

Tip: The electric ducted fan (EDF) acts like a jet aircraft, so control is generated by airspeed rather than air from a propeller moving over the control surfaces. It is recommended to use Panic Recovery while hand launching.

Takeoff

Taxi the aircraft in position for takeoff (facing into the wind if flying outdoors). Gradually increase the throttle to full power, holding a small amount of up elevator and steering with the rudder. Climb gently to check trim. Once the trim is adjusted, begin exploring the flight envelope of the aircraft.

Landing

Always land into the wind. Fly the landing pattern with a slightly nose high attitude. Use throttle management to control the decent rate of the aircraft.

During flare, keep the wings level and the airplane pointed into the wind. Gently lower the throttle while pulling back on the elevator to bring the aircraft down on the main wheels or to belly land without landing gear.

NOTICE: Always fully lower the throttle when landing the aircraft to prevent intake of foreign objects, which can damage the ducted fan and motor.

Failure to lower the throttle stick and trim to the lowest possible positions during a crash could result in damage to the ESC in the receiver unit, which may require replacement.

Low Voltage Cutoff (LVC)

When a Li-Po battery is discharged below 3V per cell, it will not hold a charge. The aircraft's ESC protects the flight battery from over-discharge using Low Voltage Cutoff (LVC). Once the battery discharges to 3V per cell, the LVC will reduce the power to the motor in order to leave adequate power to the receiver and servos to land the airplane.

When the motor power decreases, land the aircraft immediately and replace or recharge the flight battery.

Always disconnect and remove the Li-Po battery from the aircraft after each flight. Charge your Li-Po battery to about half capacity before storage. Make sure the battery charge does not fall below 3V per cell. Failure to unplug a connected battery will result in trickle discharge.

Tip: Due to the quiet nature of the aircraft, you may not hear the pulsing of the motor.

For your first flights, set your transmitter timer or a stopwatch to 3 minutes. Adjust your timer for longer or shorter flights once you have flown the model. Flights of 4 minutes are achievable if using proper throttle management.

NOTICE: Repeated flying to LVC will damage the battery.

Tip: Monitor your aircraft battery's voltage before and after flying by using a Li-Po Cell Voltage Checker (EFLA111, sold separately).

Over Current Protection (OCP)

The aircraft is equipped with Over Current Protection. OCP protects the ESC from overheating and stops the motor when the transmitter throttle is set too high and the rotor cannot turn. OCP will only activate when the throttle is positioned just above 1/2 throttle. After the ESC stops the motor, fully lower the throttle to re-arm the ESC.

For maintenance and repair information refer to the product page on www.horizonhobby.com.

Factory Control Horn Settings

The illustration shows linkage positions chosen for the most balanced aerobatic response. Linkage connections on the control horns directly affect aircraft response.

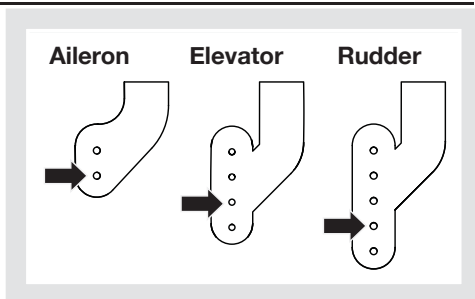

Landing Gear Removal

If desired, remove the landing gear for belly landing the aircraft in a soft landing area.

1. Lift the end of the main gear wire above the stop.
2. Gently pull the main gear away from the fuselage and away from the clips.
3. Carefully pull the nose gear from the mount.

When needed, assemble in reverse order.

Tip: The nose gear strut wire can be twisted a small amount to adjust the ground tracking. Always remove the nose gear from the aircraft before performing this adjustment.

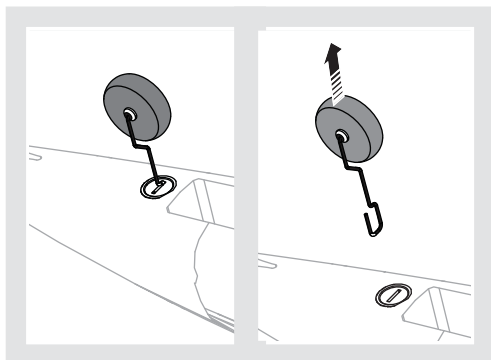
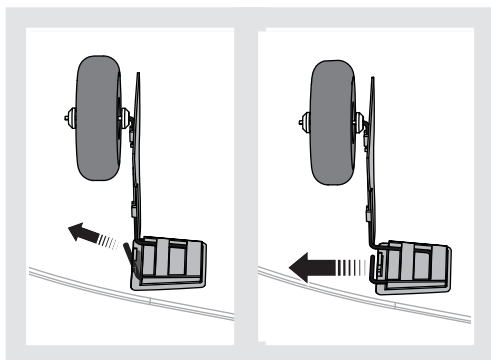

Post Flight Checklist

✓	
	1. Disconnect the flight battery from the ESC (Required for safety and battery life).
	2. Power OFF the transmitter.
	3. Remove the flight battery from the aircraft.
	4. Recharge the flight battery.

✓	
	5. Store the flight battery apart from the aircraft and monitor the battery charge.
	6. Make note of the flight conditions and flight plan results, planning for future flights.

Troubleshooting Guide

SAFE Technology		
Problem	Possible Cause	Solution
Control surfaces not at neutral position when transmitter controls are at neutral	Control surfaces may not have been mechanically centered from factory	Center control surfaces mechanically by adjusting the U-bends on control linkages
	Aircraft was moved after the flight battery was connected and before sensors initialized	Keep the Aircraft upright and immobile for 5 seconds after connecting the battery
	While centering control surfaces, aircraft is not level and in Beginner Mode	Center control surfaces only in experienced mode
Aircraft flies inconsistently from flight to flight	Trims are moved too far from neutral position	Neutralize trims and mechanically adjust linkages to center control surfaces
	Aircraft is not upright and immobile after battery is connected	Keep the Aircraft upright and immobile for 5 seconds after connecting the battery
Controls oscillate in flight, (Aircraft rapidly jumps or moves)	Rotor is unbalanced, causing excessive vibration	Remove rotor and motor. Check motor shaft for straightness and replace rotor if damaged
Aircraft does not connect to transmitter after battery is connected	Aircraft is not upright and immobile after battery is connected	Keep the Aircraft upright and immobile for 5 seconds after connecting the battery

Problem	Possible Cause	Solution
Aircraft will not respond to throttle but responds to other controls	Throttle stick and/or throttle trim too high	Reset controls with throttle stick and throttle trim at lowest setting
	Throttle channel is reversed	Reverse throttle channel on transmitter
	Motor disconnected from receiver	Open fuselage and make sure motor is connected to the receiver
Extra motor noise or extra vibration	Damaged rotor or motor	Replace damaged parts
	Rotor out of balance	Balance or replace the rotor
Reduced flight time or aircraft underpowered	Flight battery charge is low	Completely recharge flight battery
	Flight battery damaged	Replace flight battery and follow flight battery instructions
	Flight conditions may be too cold	Make sure battery is warm before use
	Battery capacity too low for flight conditions	Replace battery or use a larger capacity battery
LED on receiver flashes and aircraft will not bind to transmitter (during binding)	Transmitter too near aircraft during binding process	Power off transmitter, move transmitter a larger distance from aircraft, disconnect and reconnect flight battery to aircraft and follow binding instructions
	Bind switch or button not held long enough during bind process	Power off transmitter and repeat bind process. Hold transmitter bind button or switch until receiver is bound
	Aircraft or transmitter is too close to large metal object, wireless source or another transmitter	Move aircraft and transmitter to another location and attempt binding again

Troubleshooting Guide (Continued)

Problem	Possible Cause	Solution
LED on receiver flashes rapidly and aircraft will not respond to transmitter (after binding)	Less than a 5-second wait between first powering on transmitter and connecting flight battery to aircraft	Leaving transmitter on, disconnect and reconnect flight battery to aircraft
	Aircraft bound to different model memory (ModelMatch™ radios only)	Select correct model memory on transmitter and disconnect and reconnect flight battery to aircraft
	Flight battery/transmitter battery charge is too low	Replace/recharge batteries
	Transmitter may have been bound to a different model (or with a different DSM Protocol)	Select the right transmitter or bind to the new one
	Aircraft or transmitter is too close to large metal object, wireless source or another transmitter	Move aircraft and transmitter to another location and attempt linking again
Control surface does not move	Control surface, control horn, linkage or servo damage	Replace or repair damaged parts and adjust controls
	Wire damaged or connections loose	Do a check of wires and connections, connect or replace as needed
	Flight battery charge is low	Fully recharge flight battery
	Control linkage does not move freely	Make sure control linkage moves freely
Controls reversed	Transmitter settings reversed	Adjust controls on transmitter appropriately
Motor loses power	Damage to motor or power components	Do a check of motor and power components for damage (replace as needed)
Motor power quickly decreases and increases then motor loses power	Battery power is down to the point of receiver/ESC Low Voltage Cutoff (LVC)	Recharge flight battery or replace battery that is no longer performing
Servo locks or freezes at full travel	Travel adjust value is set above 100%, overdriving the servo	Set Travel adjust to 100% or less and/or set sub-trims to Zero and adjust linkages mechanically

Limited Warranty

What this Warranty Covers

Horizon Hobby, LLC, (Horizon) warrants to the original purchaser that the product purchased (the "Product") will be free from defects in materials and workmanship at the date of purchase.

What is Not Covered

This warranty is not transferable and does not cover (i) cosmetic damage, (ii) damage due to acts of God, accident, misuse, abuse, negligence, commercial use, or due to improper use, installation, operation or maintenance, (iii) modification of or to any part of the Product, (iv) attempted service by anyone other than a Horizon Hobby authorized service center, (v) Product not purchased from an authorized Horizon dealer, or (vi) Product not compliant with applicable technical regulations.

OTHER THAN THE EXPRESS WARRANTY ABOVE,

HORIZON MAKES NO OTHER WARRANTY OR REPRESENTATION, AND HEREBY DISCLAIMS ANY AND ALL IMPLIED WARRANTIES, INCLUDING, WITHOUT LIMITATION, THE IMPLIED WARRANTIES OF NON-INFRINGEMENT, MERCHANTABILITY AND FITNESS FOR A PARTICULAR PURPOSE. THE PURCHASER ACKNOWLEDGES THAT THEY ALONE HAVE DETERMINED THAT THE PRODUCT WILL SUITABLY MEET THE REQUIREMENTS OF THE PURCHASER'S INTENDED USE.

Purchaser's Remedy

Horizon's sole obligation and purchaser's sole and exclusive remedy shall be that Horizon will, at its option, either (i) service, or (ii) replace, any Product determined by Horizon to be defective. Horizon reserves the right to inspect any and all Product(s) involved in a warranty claim. Service or replacement decisions are at the sole discretion of Horizon. Proof

of purchase is required for all warranty claims. SERVICE OR REPLACEMENT AS PROVIDED UNDER THIS WARRANTY IS THE PURCHASER'S SOLE AND EXCLUSIVE REMEDY.

Limitation of Liability

HORIZON SHALL NOT BE LIABLE FOR SPECIAL, INDIRECT, INCIDENTAL OR CONSEQUENTIAL DAMAGES, LOSS OF PROFITS OR PRODUCTION OR COMMERCIAL LOSS IN ANY WAY, REGARDLESS OF WHETHER SUCH CLAIM IS BASED IN CONTRACT, WARRANTY, TORT, NEGLIGENCE, STRICT LIABILITY OR ANY OTHER THEORY OF LIABILITY, EVEN IF HORIZON HAS BEEN ADVISED OF THE POSSIBILITY OF SUCH DAMAGES. Further, in no event shall the liability of Horizon exceed the individual price of the Product on which liability is asserted. As Horizon has no control over use, setup, final assembly, modification or misuse, no liability shall be assumed nor accepted for any resulting damage or injury. By the act of use, setup or assembly, the user accepts all resulting liability. If you as the purchaser or user are not prepared to accept the liability associated with the use of the Product, purchaser is advised to return the Product immediately in new and unused condition to the place of purchase.

Law

These terms are governed by Illinois law (without regard to conflict of law principals). This warranty gives you specific legal rights, and you may also have other rights which vary from state to state. Horizon reserves the right to change or modify this warranty at any time without notice.

WARRANTY SERVICES

Questions, Assistance, and Services

Your local hobby store and/or place of purchase cannot provide warranty support or service. Once assembly, setup or use of the Product has been started, you must contact your local distributor or Horizon directly. This will enable Horizon to better answer your questions and service you in the event that you may need any assistance. For questions or assistance, please visit our website at www.horizonhobby.com, submit a Product Support Inquiry, or call the toll free telephone number referenced in the Warranty and Service Contact Information section to speak with a Product Support representative.

Inspection or Services

If this Product needs to be inspected or serviced and is compliant in the country you live and use the Product in, please use the Horizon Online Service Request submission process found on our website or call Horizon to obtain a Return Merchandise Authorization (RMA) number. Pack the Product securely using a shipping carton. Please note that original boxes may be included, but are not designed to withstand the rigors of shipping without additional protection. Ship via a carrier that provides tracking and insurance for lost or damaged parcels, as Horizon is not responsible for merchandise

until it arrives and is accepted at our facility. An Online Service Request is available at http://www.horizonhobby.com/content/_service-center_render-service-center. If you do not have internet access, please contact Horizon Product Support to obtain a RMA number along with instructions for submitting your product for service. When calling Horizon, you will be asked to provide your complete name, street address, email address and phone number where you can be reached during business hours. When sending product into Horizon, please include your RMA number, a list of the included items, and a brief summary of the problem. A copy of your original sales receipt must be included for warranty consideration. Be sure your name, address, and RMA number are clearly written on the outside of the shipping carton.

NOTICE: Do not ship LiPo batteries to Horizon. If you have any issue with a LiPo battery, please contact the appropriate Horizon Product Support office.

Warranty Requirements

For Warranty consideration, you must include your original sales receipt verifying the proof-of-purchase date. Provided warranty conditions have been met, your Product will be serviced or replaced free of charge. Service or replacement decisions are at the sole discretion of Horizon.

Non-Warranty Service

Should your service not be covered by warranty, service will be completed and payment will be required without notification or estimate of the expense unless the expense exceeds 50% of the retail purchase cost. By submitting the item for service you are agreeing to payment of the service without notification. Service estimates are available upon request. You must include this request with your item submitted for service. Non-warranty service estimates will be billed a minimum of ½ hour of labor. In addition you will be billed for return freight. Horizon accepts money orders and cashier's checks, as well as Visa, MasterCard, American Express, and Discover cards. By submitting any item to Horizon for service, you are agreeing to Horizon's Terms and Conditions found on our website http://www.horizonhobby.com/content/_service-center_render-service-center.

ATTENTION: Horizon service is limited to Product compliant in the country of use and ownership. If received, a non-compliant Product will not be serviced. Further, the sender will be responsible for arranging return shipment of the un-serviced Product, through a carrier of the sender's choice and at the sender's expense. Horizon will hold non-compliant Product for a period of 60 days from notification, after which it will be discarded.

Warranty and Service Contact Information

Country of Purchase	Horizon Hobby	Phone Number/Email Address	Address
United States of America	Horizon Service Center (Repairs and Repair Requests)	servicecenter.horizonhobby.com/RequestForm/	4105 Fieldstone Rd Champaign, Illinois, 61822 USA
	Horizon Product Support (Product Technical Assistance)	www.quickbase.com/db/bghj7ey8c?a=GenNewRecord 888-959-2305	
	Sales	sales@horizonhobby.com 888-959-2305	
United Kingdom	Service/Parts/Sales: Horizon Hobby Limited	sales@horizonhobby.co.uk +44 (0) 1279 641 097	Units 1-4 , Ployters Rd, Staple Tye Harlow, Essex, CM18 7NS, United Kingdom
Germany	Horizon Technischer Service Sales: Horizon Hobby GmbH	service@horizonhobby.de +49 (0) 4121 2655 100	Christian-Junge-Straße 1 25337 Elmshorn, Germany
France	Service/Parts/Sales: Horizon Hobby SAS	infofrance@horizonhobby.com +33 (0) 1 60 18 34 90	11 Rue Georges Charpak 77127 Lieusaint, France
China	Service/Parts/Sales: Horizon Hobby – China	info@horizonhobby.com.cn +86 (021) 5180 9868	Room 506, No. 97 Changshou Rd. Shanghai, China 200060

IC Information

This device complies with Industry Canada license-exempt RSS standard(s). Operation is subject to the following two conditions: (1) this device may not cause interference, and (2) this device must accept any interference, including interference that may cause undesired operation of the device.

FCC Information

This device complies with part 15 of the FCC Rules. Operation is subject to the following two conditions: (1) This device may not cause harmful interference, and (2) this device must accept any interference received, including interference that may cause undesired operation.

Compliance Information for the European Union

Declaration of Conformity

(in accordance with ISO/IEC 17050-1)
No. HH2014092001

C **E** Product(s): UMX Habu S DF180m BNF
Item Number(s): EFLU4380
Equipment class: 1

The object of declaration described above is in conformity with the requirements of the specifications listed below, following the provisions of the European R&TTE directive 1999/5/EC and LVD Directive 2006/95/EC:

EN 301 489-1 V1.9.2: 2012

EN 301 489-17 V2.1.1: 2009

EN60950-1:2006+A11:2009+A1:2010+A12: 2011

Signed for and on behalf of:
Horizon Hobby, LLC
Champaign, IL USA
September 20, 2014



Mike Dunne
Executive Vice President
Product Divisions
Horizon Hobby, LLC

Instructions for disposal of WEEE by users in the European Union



This product must not be disposed of with other waste. Instead, it is the user's responsibility to dispose of their waste equipment by handing it over to a designated collections point for the recycling of waste electrical and electronic equipment. The separate collection and recycling of your waste equipment at the time of disposal will help to conserve natural resources and ensure that it is recycled in a manner that protects human health and the environment. For more information about where you can drop off your waste equipment for recycling, please contact your local city office, your household waste disposal service or where you purchased the product.

Replacement Parts – Ersatzteile – – Pièces de rechange – Pezzi di ricambio –

Part # • Nummer Numéro • Codice	Description	Beschreibung	Description	Descrizione
EFLU4446	Pushrod Linkage Set: UMX Habu BNF Basic	E-flite UMX Habu BNF Basic: Gestänge / Anlenkungen	Set de tringleries: UMX Habu BNF Basic	Set barrette comandi: UMX Habu BNF Basic
EFLU4355	Landing Gear Set: UMX Habu S	E-flite UMX Habu S: Fahrwerkset	Train d'atterrissage: UMX Habu S	Set carrello: UMX Habu S
EFLU4358	Fuselage Set w/ Accessories: UMX Habu S	E-flite UMX Habu S: Rumpf m. Zbh.	Fuselage avec accessoires: UMX Habu S	Set fusoliera con accessori: UMX Habu S
EFLU4359	Wing: UMX Habu S	E-flite UMX Habu S: Tragfläche	Aile: UMX Habu S	Ala: UMX Habu S
EFLU4360	Tail Set w/ Accessories: UMX Habu S	E-flite UMX Habu S: Leitwerk m. Zbh	Empennages avec accessoires: UMX Habu S	Set coda con accessori: UMX Habu S
EFLU4363	Canopy/Hatch: UMX Habu S	E-flite UMX Habu S: Kabinenhaube/ Klappe	Verrière: UMX Habu S	Copertura c/capottina: UMX Habu S
EFLU4365	Decal Set: UMX Habu S	Dekorbogen: UMX Habu S	Set de décoration: UMX Habu S	Set adesivi: UMX Habu S
EFLDF180m	Delta-V 180m 28mm EDF Unit	E-flite Delta-V 180m 28mm Impellereinheit	UMX MiG 15 BNF- Turbine Delta-V 180m 28mm	Gruppo Delta-V 180m 28mm EDF
EFLDF180m1	Rotor: Delta-V 180m	E-flite Rotor: Delta-V 180m	UMX MiG 15 BNF -Rotor 180m	Rotore: Delta-V 180m
EFLM30180mDFB	BL180m Ducted Fan Motor, 11750Kv	E-flite BL180m Impeller Motor: 11750Kv	UMX MiG 15 BNF -Moteur 180m 11750Kv	Ventola intubata BL180m con motore, 11750Kv
EFLB2002S25	200mAh 2s 7.4V DC Li-Po, 26AWG	200mAh 2S 7.4V 25C Li-Po Akku	200mAh 2S 7.4V 25C Li-Po, 26AWG	200mAh 2S 7.4V 25C Li-Po, 26AWG
EFLUC1007	Celectra 2S 7.4V DC Li-Po Charger	Celectra 2S 7.4V DC Li-Po Ladegerät	Celectra Chargeur Li-Po 7.4V 2S	Celectra 2S 7.4V DC Li-Po Caricabatterie
SPMA3165	UMX Habu S Replacement Receiver/ESC unit	UMX Habu S Ersatzempfänger / Regler	Module RX/Contrôleur de remplacement : UMX Habu S	Ricambio unità ricevente/ESC
SPMSA2030L	2.3-Gram Performance Linear Long Throw Servo	2,3 Gramm Servo m. langen Ruderweg (Klappen)	Servo linéaire de performance course longue 2,3 g (volets)	Servo corsa lunga lineari a prestazioni elevate da 2,3 grammi (Alette)
SPM6836	Replacement Servo Mechanics: 2.3- Gram 2030L	Ersatzservomechanik 2,3 Gramm 2030L	Pièces de rechange mécaniques servo : 2,3 g 2030 L	Componenti meccanici di ricambio del servo: 2030L da 2,3 grammi

– Optional Parts and Accessories –
– Optionale Bauteile und Zubehörteile –
– Pièces optionnelles et accessoires –
– Pezzi opzionali e accessori –

Part # • Nummer Numéro • Codice	Description	Beschreibung	Description	Descrizione
PKZ1039	Hook and Loop Set (5): Ultra Micros	Klettband (5): Ultra Micros	Bande auto-agrippante (5)	Set fascette fissaggio (5): Ultra Micros
EFLB2002S30	200mAh 2s 7.4V 30C DC Li-Po, 26AWG	200mAh 2S 7.4V 30C Li-Po Akku	200mAh 2S 7.4V 30C Li-Po, 26AWG	200mAh 2S 7.4V 30C Li-Po, 26AWG
EFLA700UM	Charger Plug Adapter: EFL	Ladekabel Adapter EFL	Prise d'adaptation chargeur: EFL	Adattatore connettore caricabatterie: EFL
EFLA7001UM	Charger Plug Adapter: Thunder Power	Ladekabel Adapter Thunder Power	Prise d'adaptation chargeur: Thunder Power	Adattatore connettore caricabatterie: Thunder Power
SPM6825	Ultra Micro Linear Servo Reverser	Spektrum Ultra Micro Linear Servo Reverser	Inverseur d'ultra micro servo linéaire	Invertitore per servi lineari ultra micro
EFLC4000/UK/AU/EU	AC to 12V DC, 1.5 Amp Power Supply (Based upon your sales Region)	Netzteil 12V 1,5 A (Basierend nach Vertriebsregion)	Alimentation CA vers 12V CC, 1,5 A (En fonction de votre région)	Alimentatore CA - 12V CC da 1,5 A (in base al Paese di vendita)
	DX4e DSMX 4-Channel Transmitter	DX4e DSMX 4-Kanal Sender	Emetteur DX4e DSMX 4 voies	DX4e DSMX Trasmettitore 4 canali
	DX5e DSMX 5-Channel Transmitter	DX5e DSMX 5-Kanal Sender	Emetteur DX5e DSMX 5 voies	DX5e DSMX Trasmettitore 5 canali
	DX6 DSMX 6-Channel Transmitter	DX6 DSMX 6-Kanal Sender	Emetteur DX6 DSMX 6 voies	DX6 DSMX Trasmettitore 6 canali
	DX7s DSMX 7-Channel Transmitter	Spektrum DX7s 7 Kanal Sender	Emetteur DX7s DSMX 7 voies	DX7s DSMX Trasmettitore 7 canali
	DX8 DSMX Transmitter	Spektrum DX8 nur Sender	Emetteur DX8 DSMX 8 voies	DX8 DSMX Solo trasmettitore
	DX9 DSMX Transmitter	Spektrum DX9 nur Sender	Emetteur DX9 DSMX 9 voies	DX9 DSMX Solo trasmettitore
	DX10T DSMX Transmitter	Spektrum DX10T nur Sender	Emetteur DX10T DSMX 10 voies	DX10T DSMX Solo trasmettitore
	DX18 DSMX Transmitter	Spektrum DX18 nur Sender	Emetteur DX18 DSMX 18 voies	DX18 DSMX Solo trasmettitore

© 2014 Horizon Hobby, LLC.

E-flite, SAFE and the SAFE Logo, AS3X, Delta-V, Blade, Celectra, UMX, DSM, DSM2, DSMX, ModelMatch, Bind-N-Fly, the Bind-N-Fly logo and the Horizon Hobby logo are trademarks or registered trademarks of Horizon Hobby, LLC.

The Spektrum trademark is used with permission of Bachmann Industries, Inc.

Futaba is a registered trademark of Futaba Denshi Kogyo Kabushiki Kaisha Corporation of Japan.

US 7,898,130. US D578,146. PRC ZL 200720069025. PRC ZL 2007001249. Other patents pending.

www.e-fliterc.com

