

Sport Cub S 2



SAFE®

RTF

READY-TO-FLY

BNF
BASIC

HORIZON
H O B B Y

NOTICE

All instructions, warranties and other collateral documents are subject to change at the sole discretion of Horizon Hobby, LLC. For up-to-date product literature, visit horizonhobby.com or towerhobbies.com and click on the support or resources tab for this product.

Meaning of Special Language:

The following terms are used throughout the product literature to indicate various levels of potential harm when operating this product:

WARNING: Procedures, which if not properly followed, create the probability of property damage, collateral damage, and serious injury OR create a high probability of superficial injury.

CAUTION: Procedures, which if not properly followed, create the probability of physical property damage AND a possibility of serious injury.

NOTICE: Procedures, which if not properly followed, create a possibility of physical property damage AND little or no possibility of injury.



WARNING: Read the ENTIRE instruction manual to become familiar with the features of the product before operating. Failure to operate the product correctly can result in damage to the product, personal property and cause serious injury.

This is a sophisticated hobby product. It must be operated with caution and common sense and requires some basic mechanical ability. Failure to operate this product in a safe and responsible manner could result in injury or damage to the product or other property. This product is not intended for use by children without direct adult supervision. Do not use with incompatible components or alter this product in any way outside of the instructions provided by Horizon Hobby, LLC. This manual contains instructions for safety, operation and maintenance. It is essential to read and follow all the instructions and warnings in the manual, prior to assembly, setup or use, in order to operate correctly and avoid damage or serious injury.

Age Recommendation: Not for children under 14 years. This is not a toy.

Safety Precautions and Warnings

- Always keep a safe distance in all directions around your model to avoid collisions or injury. This model is controlled by a radio signal subject to interference from many sources outside your control. Interference can cause momentary loss of control.
- Always operate your model in open spaces away from full-size vehicles, traffic and people.
- Always carefully follow the directions and warnings for this and any optional support equipment (chargers, rechargeable battery packs, etc.).
- Always keep all chemicals, small parts and anything electrical out of the reach of children.
- Always avoid water exposure to all equipment not specifically designed and protected for this purpose. Moisture causes damage to electronics.
- Never place any portion of the model in your mouth as it could cause serious injury or even death.
- Never operate your model with low transmitter batteries.
- Always keep aircraft in sight and under control.
- Always use fully charged batteries.
- Always keep the transmitter powered on while aircraft is powered.
- Always remove batteries before disassembly.
- Always keep moving parts clean.
- Always keep parts dry.
- Always let parts cool after use before touching.
- Always remove batteries after use.
- Always ensure failsafe is properly set before flying.
- Never operate aircraft with damaged wiring.
- Never touch moving parts.

Included in the Box

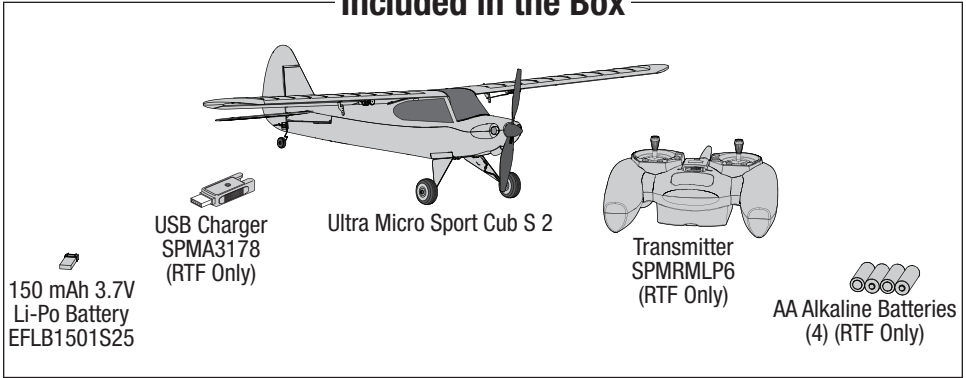

Flying Tips

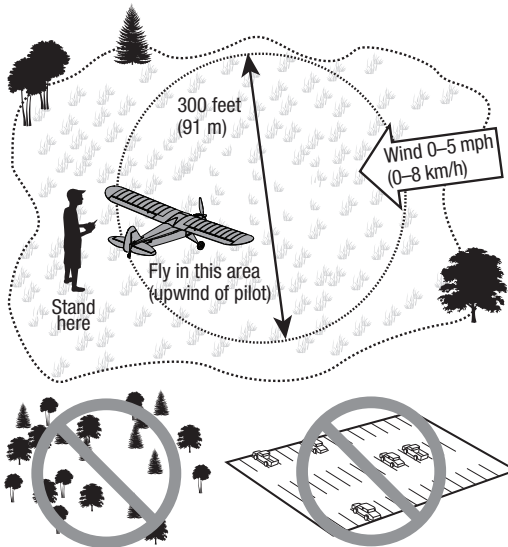

- Consult local laws and ordinances before choosing a location to fly your aircraft.
- Sensor Assisted Flight Envelope (SAFE®) technology is designed as flight assistance, not an autopilot. The pilot is always in control and required to fly the aircraft at all times.
- Start in Beginner mode (SAFE switch position 0). As you learn and become more confident, change modes to advance your flying skills.
- Always make deliberate and steady control stick movements for smooth control of your aircraft.
- Fly your aircraft outside in no greater than light winds.
- For indoor flight, fly the aircraft inside in a large gymnasium.
- Keep your aircraft in plain sight and up wind.
- Always avoid flying near houses, trees, wires and buildings.
- Always avoid flying in areas where there are many people, such as busy parks, schoolyards or soccer fields.

Preflight Checklist

✓	
	1. Find a safe and open area.
	2. Set up your transmitter to support SAFE technology (BNF only).
	3. Charge flight battery.
	4. Install flight battery in aircraft.
	5. Perform Control Direction Test.

✓	
	6. Perform SAFE Control Direction Test.
	7. Plan flight for flying field conditions.
	8. Set a flight timer for 5 minutes.
	9. Have fun!

Transmitter

Low Battery Alarm

When the battery voltage drops too low, an alarm sounds and the LED flashes. The batteries must be replaced immediately. If this happens while flying, land your aircraft as soon and as safely as possible.

Mode 2 shown

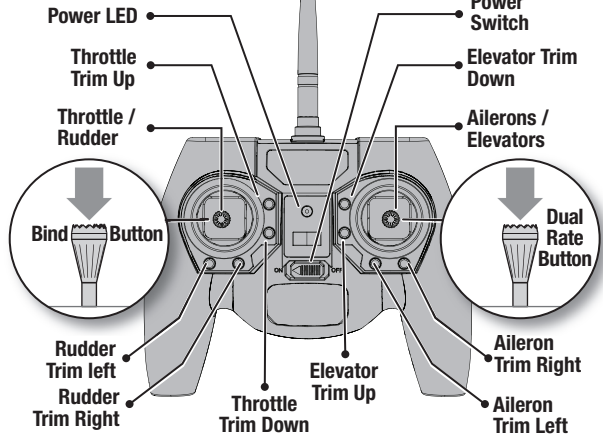
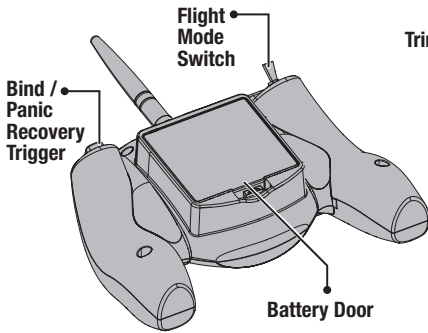

Transmitter Batteries Installation

Remove the battery cover. Install the four included batteries (noting proper polarity) and reinstall the battery cover.

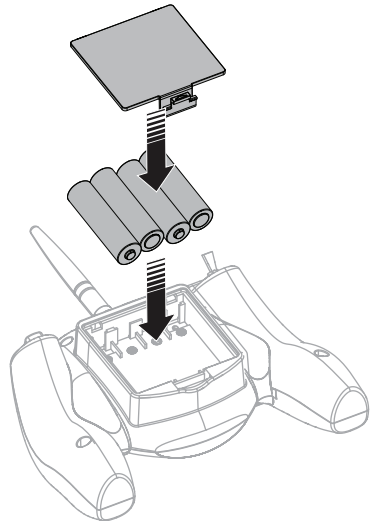

LED Indicator

The transmitter LED gives a visual representation for various data. The following table gives an explanation of the possible LED indications.

Status	Transmitter LED/Buzzer Indication
Transmitter voltage	Transmitter LED color indicates transmitter battery voltage for 4 seconds after powering on. Green: over 5.6V Yellow: between 4.8V and 5.6V Red: < 4.8V, transmitter beeps (change the batteries)
Aircraft voltage* (the aircraft must be bound and include a telemetry capable receiver)	Transmitter LED color indicates aircraft on-board battery voltage. When using MLP6 with aircraft that does not transmit telemetry, LED will be solid blue. Green: over 3.7V per cell Yellow: between 3.3V and 3.7V per cell Red: below 3.3V per cell
Control rate	High rate: LED solid Low rate: LED flashes slowly
Binding	LED flashes blue rapidly
No signal	LED glows solid blue

* To take advantage of the telemetry features, the transmitter must be bound to a receiver that is telemetry capable. See your aircraft manual for more information.



Transmitter Setup

IMPORTANT: The installed receiver has been programmed for operation specifically in this aircraft.

To operate the SAFE system in this aircraft, set up your optional DSM2/DSMX transmitter using the chart below.

- SAFE Flight mode is selected using Channel 5 signal (high, middle, low)
- Panic Recovery mode is selected with Channel 6 signal (high, low)

IMPORTANT: A transmitter with a 2-position Channel 5 switch will only allow the use of position 0 or position 2 flight modes. If possible assign Channel 5 in your transmitter to a 3-position switch to operate all 3 flight modes (refer to your transmitter manual).

Refer to your transmitter's manual for more information about transmitter setup.

Non Computerized Transmitter Setup (DX4e and DX5e)

Transmitter	SAFE Mode Switch	Panic Recovery Switch	SAFE Flight Modes Supported
Throttle, Aileron, Elevator and Rudder in Normal Position			
DX4e (2pos switch)	ACT/AUX switch	Trainer Button	2 Pos Flight Mode
DX4e (3pos switch)	CH 5 switch	Trainer Button	3 Pos Flight Mode
DX5e (2pos switch)	CH 5 switch	Trainer Switch	2 Pos Flight Mode
DX5e (3pos switch)	CH 5 switch	Trainer Switch	3 Pos Flight Mode

Computerized Transmitter Setup (DX6i, DX6, DX7S, DX8, DX9, DX10t and DX18)

Start all transmitter programming with a blank model (do a model reset), then name the model.

Set Dual Rates to:	HIGH 100%
	LOW 70%
DX6i	1. Go to the SETUP LIST MENU
	2. Set MODELTYPE: ACRO
	3. Set REVERSE: Gear Channel
	4. Go to ADJUST LIST MENU
	5. Set TRAVEL ADJ: Gear/Fmode (0) ↑ 100%; Gear/Fmode (1) ↓ 40%
	6. Set FLAPS: Norm ↑ 100; LAND ↓ 100
	7. Set MIX 1: ACT; Gear → Gear ACT, RATE D 0%; U + 100%, SW MIX, TRIM INH
Resulting in:	The Gear and Mix switches operate the 3 SAFE modes Gear 0; Mix 0 = Beginner Mode Gear 1; Mix 0 = Intermediate Mode Gear 1; Mix 1 = Experienced Mode The Flap switch operates Panic Recovery. Position 0, Panic Recovery off, Position 1 Panic Recovery on
DX7S DX8	1. Go to the SYSTEM SETUP
	2. Set MODEL TYPE: AIRPLANE
	3. Set SWITCH SELECT: Change all to INH then TRAINER: AUX1, FLAP: GEAR
	4. Go to the FUNCTION LIST
	5. Set SERVO SETUP: Reverse AUX1
Resulting in:	Flap/Gyro Switch operates the 3 SAFE modes (0 Beginner/1 Intermediate/2 Experienced) The Trainer/Bind button operates Panic Recovery
DX6 DX9 DX10t DX18	1. Go to the SYSTEM SETUP
	2. Set MODEL TYPE: AIRPLANE
	3. Go to CHANNEL ASSIGN: click NEXT to go to Channel Input Config: Set GEAR: D (DX10t: GEAR: A) Set AUX1: i (DX10t: AUX1: R-tip)
	4. Go to the FUNCTION LIST
	5. Set SERVO SETUP: Reverse AUX1
Resulting in:	Switch D (DX10t: A) operates the 3 SAFE modes (0 beginner/1 intermediate/2 Experienced) The Bind/I button (DX10t: R-tip) operates Panic Recovery

SAFE® Technology Flight Modes

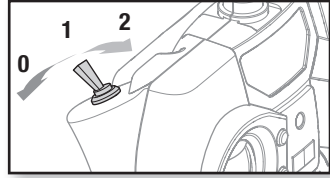

Beginner Mode (with self leveling)

Pitch (nose up and down) and Roll (wing tips up and down) angles are limited to help you keep the aircraft airborne. Release both sticks for self-leveling.

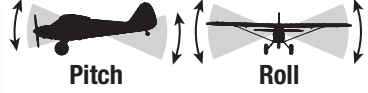

Beginner Mode
(Switch Position 0)

Intermediate Mode

The pilot is only prevented from entering extreme flight conditions.

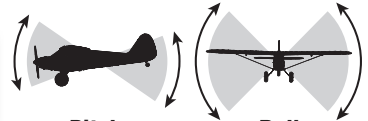

Intermediate Mode
(Switch Position 1)

Experienced Mode

Unlimited Flight Envelope

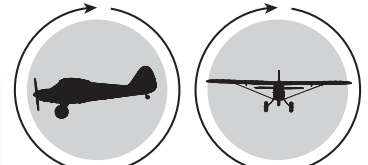

Experienced Mode
(Switch Position 2)

Panic Recovery Mode

If you feel you have lost control in any mode, hold the Panic Recovery trigger. The SAFE technology will return the aircraft to a stable attitude (wings level with a slight climb). Always fly at a safe altitude, as Panic Recovery may cause the aircraft to lose some altitude when leveling the wings. Release the Panic Recovery trigger to turn off Panic mode and return to the current SAFE flight mode.

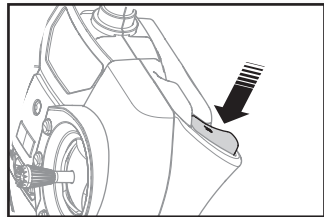

NOTICE: If the aircraft is upside down when the Panic Recovery trigger is pressed, sufficient altitude is required for the aircraft to return to straight and level flight.

Charging Warnings

The included USB charger has been designed to safely charge the included Li-Po battery.



CAUTION: All instructions and warnings must be followed exactly. Mishandling of Li-Po batteries can result in a fire, personal injury and/or property damage.

- By handling, charging or using the included Li-Po battery, you assume all risks associated with lithium batteries.
- If at any time the battery begins to balloon or swell, discontinue use immediately. If charging or discharging, discontinue and disconnect. Continuing to use, charge or discharge a battery that is ballooning or swelling can result in fire.
- Always store the battery at room temperature in a dry area for best results.
- Always transport or temporarily store the battery in a temperature range of 40–120° F. Do not store the battery or model in a car or direct sunlight. If stored in a hot car, the battery can be damaged or even catch fire.
- Always charge batteries away from flammable materials.
- Always inspect the battery before charging.
- Always disconnect the battery after charging, and let the charger cool between charges.
- Always constantly monitor the temperature of the battery pack while charging.
- **ONLY USE A CHARGER SPECIFICALLY DESIGNED TO CHARGE LI-PO BATTERIES.** Failure to charge the battery with a compatible charger may cause a fire resulting in personal injury and/or property damage.
- Never discharge Li-Po cells to below 3V under load.
- Never cover warning labels with hook and loop strips.
- Never leave charging batteries unattended.
- Never charge batteries outside recommended levels.
- Never charge damaged batteries.
- Never attempt to dismantle or alter the charger.
- Never allow minors to charge battery packs.
- Never charge batteries in extremely hot or cold places (recommended between 40–120° F or 5–49° C) or place in direct sunlight.

Charging the Flight Battery



CAUTION: Once charging is complete, immediately remove the battery. Never leave a battery connected to the charger.

1. Insert the charger into a USB port.
2. Properly connect the battery to the charger.

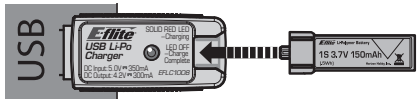
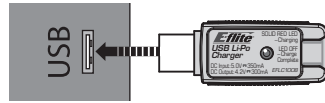

Charging a fully discharged (not over-discharged) 150 mAh battery takes approximately 45 minutes. The LED goes out when the charge is complete.



CHARGING (Solid Red).....	
MAX CHARGE (Off).....	



Installing the Flight Battery

Your Sport Cub RTF transmitter comes pre-bound to the aircraft, so binding should not be necessary.

Keep the aircraft and transmitter away from large metal objects, wireless sources or other transmitters while installing the battery.

⚠ CAUTION: Always disconnect the Li-Po flight battery from the aircraft receiver when not flying to avoid over-discharging the battery. Batteries discharged to a voltage lower than the lowest approved voltage may become damaged, resulting in loss of performance and potential fire when batteries are charged.

⚠ CAUTION: Always keep hands away from the propeller. When armed, the motor will turn the propeller in response to any throttle movement.

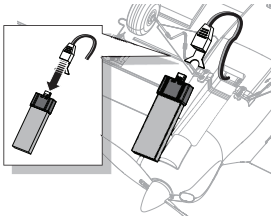
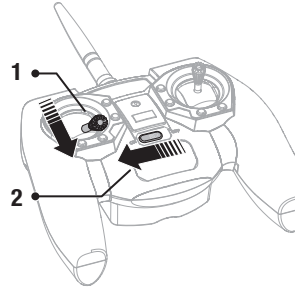

For best flight performance, install the battery all the way back as shown.

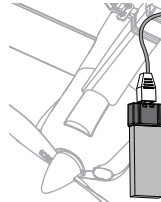

Place aircraft on its landing gear.

Keep immobile and out of the wind for 5 seconds.

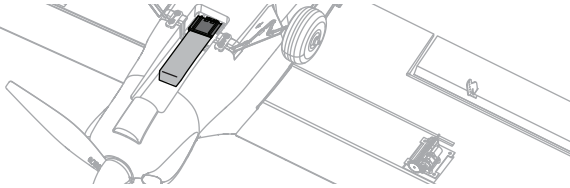

Bind-N-Fly® Ready to fly, redefined.

Binding

For a list of compatible DSM2/DSMX transmitters, please visit www.bindnfly.com.

⚠ CAUTION: When using a Futaba® transmitter with a Spektrum DSM module, you must reverse the throttle channel and rebind. Refer to your Spektrum module manual for binding and failsafe instructions. Refer to your Futaba transmitter manual for instructions on reversing the throttle channel.

Binding Procedure

1. Refer to your transmitter's unique instructions for binding to a receiver.
2. Make sure the flight battery is disconnected from the aircraft.
3. Ensure the transmitter is powered OFF.
4. Connect the flight battery to the aircraft and turn the aircraft upright. The receiver LED will begin to flash (typically after 5 seconds).
5. Make sure the transmitter controls are at neutral and the throttle is in the low position.
6. Put your transmitter into bind mode.
7. After 5 to 10 seconds, the receiver status LED will become solid, indicating that the receiver is bound to the transmitter. If the LED does not turn solid, refer to the Troubleshooting Guide at the end of the manual.
8. Disconnect the flight battery and power the transmitter off.

For subsequent flights, power ON the transmitter for 5 seconds before connecting the flight battery.

Control Direction Test

1. Place the aircraft into **Experienced mode** (Mode switch position 2).
2. Face the aircraft away from you.
3. Restrain the aircraft so it does not escape your control while you are testing your transmitter controls.
4. Move the sticks on the transmitter to ensure the aircraft responds as shown.
5. If the aircraft responds as shown, move the SAFE® mode switch to **Beginner mode** (Position 0) to prepare to fly.

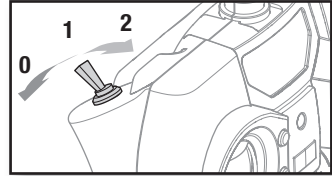

**Experienced Mode
(Switch Position 2)**

Refer to the Binding instructions and Troubleshooting Guide in this manual for more information. If you need more assistance, contact the appropriate Horizon Hobby Product Support department.



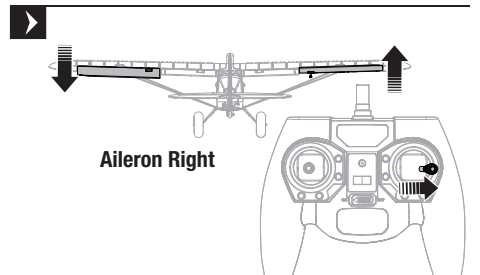
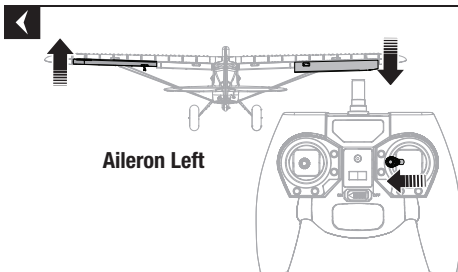
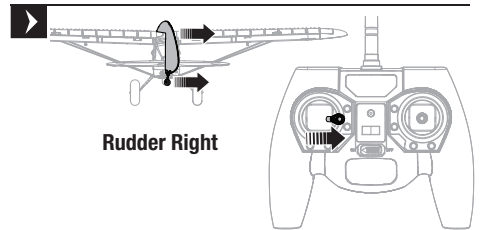
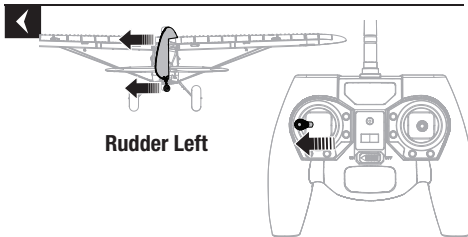
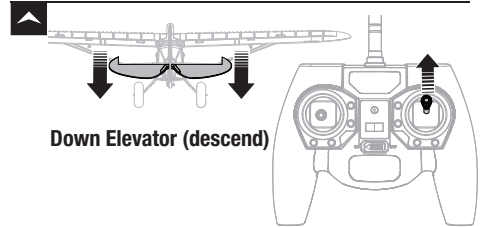
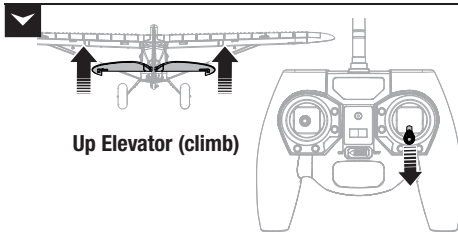





Mode 2 shown

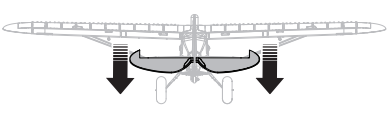

SAFE® Control Direction Test

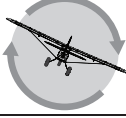
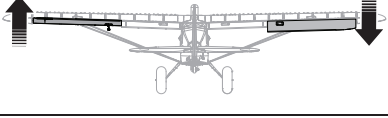
Perform the Control Direction Test to ensure the aircraft responds correctly to your transmitter. Once you are sure the aircraft responds correctly, move the aircraft as shown to ensure the SAFE system moves the control surfaces in their proper direction. If the control surfaces do not respond as shown, do not fly the aircraft. Contact Horizon Hobby Product Support.

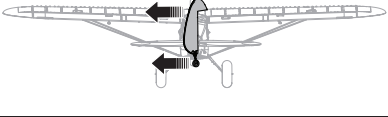
The SAFE system will not activate until the throttle stick or trim is increased for the first time after the flight battery is connected. Once the SAFE is active, the control surfaces may move rapidly on the aircraft. This is normal. SAFE will remain active until the battery is disconnected.

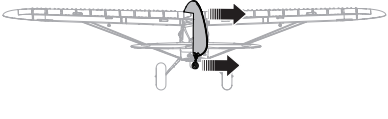
	Aircraft Movement	SAFE Reaction
Elevator		
		
Aileron		
		
Rudder		
		

Takeoff

Hand Launch

Use the Beginner mode for takeoff in first flights.

Get help to hand launch your aircraft so you can concentrate on flying. If you must hand launch the aircraft alone, hold the Aircraft in your dominant hand and the transmitter in your other hand.

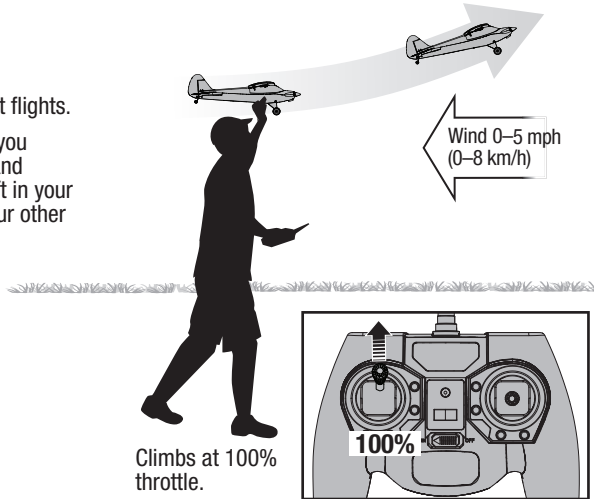

Ground Launch

- Take off from a hard and level runway.
- Use the rudder control to keep the aircraft rolling straight.
- Turn the aircraft only after it is high off the ground.

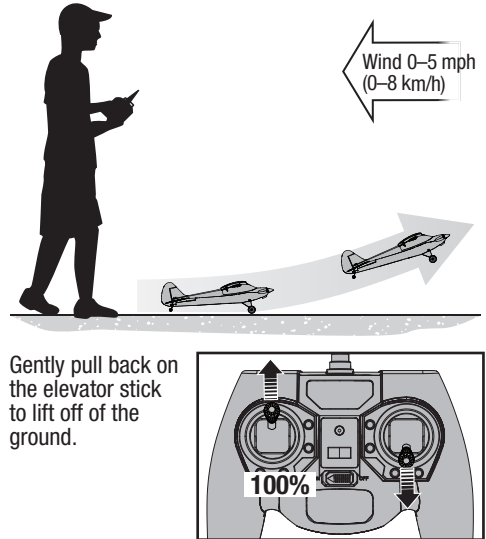

Flying

In Beginner mode, when properly trimmed, your aircraft will climb at full throttle without use of the elevator stick.

- Set a flight timer for 6 minutes.
- If the motor pulses, land the aircraft immediately and recharge the flight battery.
- Flying with the nose pointed toward you is one of the hardest things to do when learning to fly. To practice piloting the aircraft, try flying in large circles high off the ground.

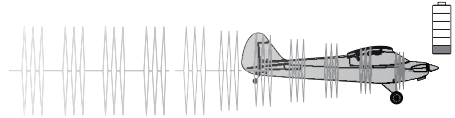
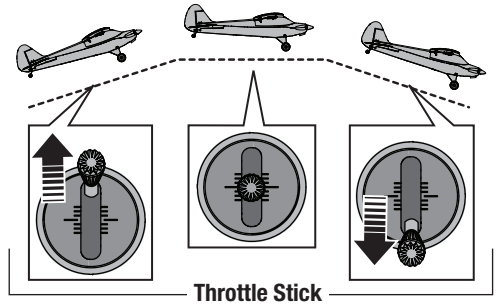

Adjusting Trim in Flight

Familiarize yourself with your transmitter's controls and the aircraft's response before flying by performing the recommended Control Direction Test. Press the trim buttons on your transmitter to adjust how the aircraft flies.

If the aircraft's nose drifts while the sticks are at neutral (centered) and the throttle is at 50%, press the trim buttons:

- Upper button to stop up drift
- Lower button to stop down drift
- Left button to stop right drift
- Right button to stop left drift
- Left button to stop right roll
- Right button to stop left roll

If you press a trim button until no beep sounds and the aircraft does not fly straight and level, land and manually adjust the trim as described below.

Manually Adjusting Trim

Press the trim buttons to return to center (3 beeps will sound), then use a pair of pliers to carefully bend the metal U-Bend:

Only adjust elevator to neutral position immediately after powering on and before SAFE has been activated by advancing the throttle.

- Narrow for negative adjustment (Down elevator/aileron or rudder left)
- Widen for positive adjustment (Up elevator/aileron or rudder right)

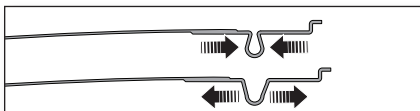

Direction of Drift	Button to Correct

Landing

Fly to your runway, keeping the aircraft pointed into the wind and the wings level. Bring the aircraft down by lowering the throttle to 25%. Near the ground, fully lower the throttle and pull back on the steering stick.

Wind 0–5 mph
(0–8 km/h)

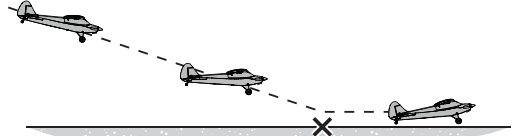

CAUTION: Never catch a flying aircraft in your hands. Doing so could cause personal injury and damage to the aircraft.

After Flying

1. Lower the throttle stick completely and do not move the steering stick. Wait at least 5 seconds.
2. Disconnect and remove the battery from the aircraft. Keep hands away from the propeller.
3. Power off the transmitter.
4. Fully charge the aircraft battery.
5. Remove the battery after charging is complete.

NOTICE: When you are finished flying, never leave the aircraft in direct sunlight or in a hot, enclosed area such as a car. Doing so can damage the foam.

NOTICE: Always disconnect the battery from the aircraft before powering off the transmitter or injury and damage may result.

Repairs

Repair this aircraft using foam-compatible CA (cyanoacrylate adhesive) glue or clear tape. Only use foam-compatible CA glue as other types of glue can damage the foam. When parts are not repairable, see the Replacement Parts List for ordering by item number.

For a listing of all replacement and optional parts, refer to the list at the back of this manual.

NOTICE: Use of foam-compatible CA accelerant on your aircraft can damage paint. DO NOT handle the aircraft until the accelerant fully dries.

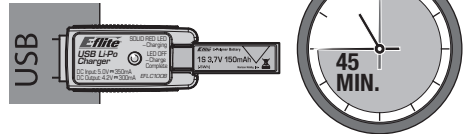
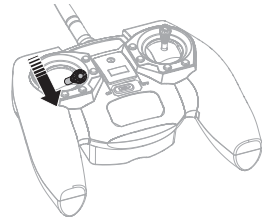
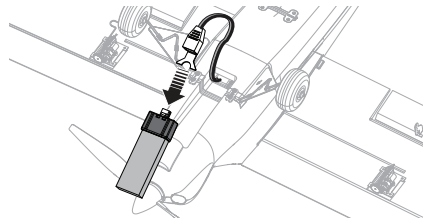
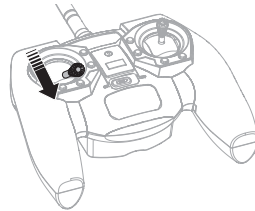

Settings for Control Horns

The illustration shows factory settings for linkages on the control horns. After flying, if you want to modify control throw, carefully adjust the linkage positions for desired control response.

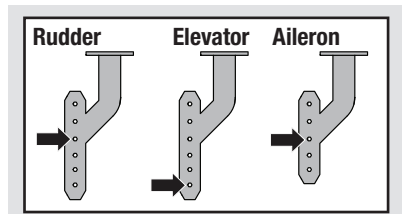

Motor Service

CAUTION: DO NOT handle propeller parts while the flight battery is connected. Personal injury could result.

Disassembly

1. Disconnect the battery from the ESC/receiver.
2. Carefully cut the tape and decals on the side of the fuselage and behind the canopy to remove the top of the fuselage.

IMPORTANT: Removing tape or decals can remove paint from the fuselage.

3. Hold the prop shaft using needle-nose pliers or hemostats.
4. Turn the propeller counterclockwise (facing the front of the model) to remove. Turn the propeller clockwise to install.
5. Carefully remove the damaged spinner and glue from the propeller.
6. Hold the nut (A) on the end of the prop shaft using needle-nose pliers or hemostats.
7. Turn the gear on the shaft clockwise (facing the front of the model) to remove the nut.
8. Gently pull the shaft (B) from the gearbox (C) and make sure the washer (D) and two bushings (E) are not lost.
9. Disconnect the motor from the ESC/receiver.
10. Gently push the motor out of the gearbox and remove the motor through the top of the fuselage behind the ESC/receiver.

NOTICE: DO NOT remove the gearbox from the aircraft. Damage to the aircraft will result.

Assembly

Assemble the aircraft using the instructions above in reverse order.

- Correctly align the prop shaft gear with the pinion gear on the motor.
- Connect the motor to the ESC/receiver so that the powered motor turns the propeller counterclockwise (facing the front of the model).
- Make sure the propeller size numbers (130 x 70) face away from the motor (see illustration).
- Attach the spinner to the propeller using foam-compatible CA (Cyanoacrylate adhesive).
- Assemble the fuselage using clear tape.

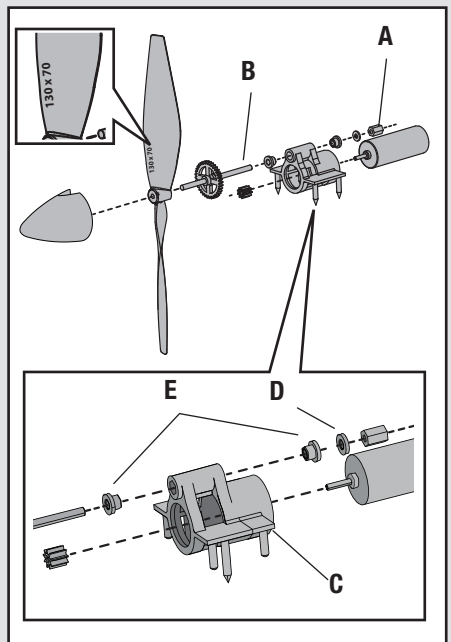
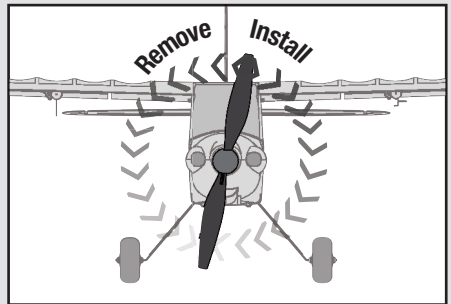
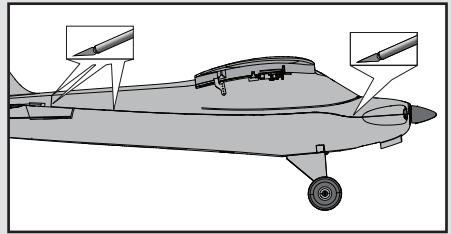

Optional Floats

To fly this aircraft off water, install the optional E-flite® Float Set (EFLUA1190, sold separately).

A rear float mount is included with the aircraft. Install it in the open slot on the bottom of the fuselage using foam-compatible CA. Refer to the float manual for installation instructions.

Taking Off on Water

To take off on water, steer with the rudder and slowly increase the throttle.

Keep the wings level on takeoff. Hold a small amount (1/4–1/3) of up elevator and the aircraft will lift off once flying speed is reached. Avoid rapidly increasing the throttle, as torque from the motor may cause the aircraft to roll to the left when on water.

Landing on Water

To land on water, fly the aircraft to a couple of feet off the surface of the water. Reduce throttle and add up elevator to flare the aircraft.

When taxiing, you must use some throttle to create propeller blast over the rudder to steer, as there is no water rudder.

Avoid taxiing cross wind if there is a breeze, as this can cause the aircraft to flip over if the wind gets under the upwind wing. Taxi 45 degrees into the direction of the wind (not perpendicular to the wind) and use aileron to hold the upwind wing down.

The aircraft will try to face into the wind when taxiing. The wind naturally turns the aircraft to face into the wind.

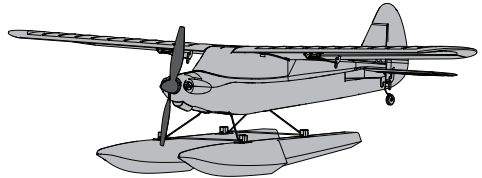
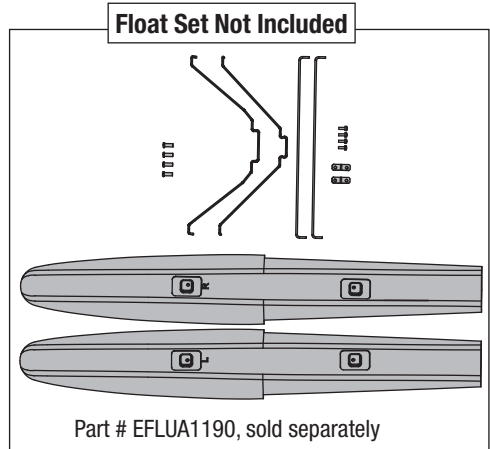



Re-Binding the RTF Transmitter

READY-TO-FLY

Your Sport Cub RTF transmitter comes pre-bound to the aircraft. If you need to re-bind your aircraft, follow this binding table.

Binding Procedure

1. Make sure the flight battery is disconnected from the aircraft.
2. Ensure the transmitter is powered OFF.
3. Connect the flight battery to the aircraft and turn the aircraft upright. The receiver LED will begin to flash (typically after 5 seconds).
4. Make sure the transmitter controls are at neutral and the throttle is in the low position.
5. Put the transmitter into bind mode by pushing the left control stick vertically into the case (until it clicks) while powering ON the transmitter. Release the transmitter stick.
6. After 5 to 10 seconds, the receiver status LED will become solid, indicating that the receiver is bound to the transmitter. If the LED does not turn solid, refer to the Troubleshooting Guide at the end of the manual.
7. Disconnect the flight battery and power the transmitter off.

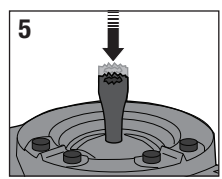
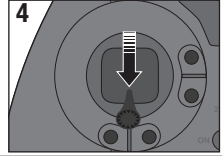

Troubleshooting Guide (SAFE)

Problem	Possible Cause	Solution
Control surfaces not at neutral position when transmitter controls are at neutral	Control surfaces may not have been mechanically centered from factory	Center control surfaces mechanically by adjusting the U-bends on control linkages
	Aircraft was moved after the flight battery was connected and before sensors initialized	Keep the Aircraft upright and immobile for 5 seconds after connecting the battery
Aircraft flies inconsistently from flight to flight	Trims are moved too far from neutral position	Neutralize trims and mechanically adjust linkages to center control surfaces
Controls oscillate in flight, (Aircraft rapidly jumps or moves)	Propeller is unbalanced, causing excessive vibration	Remove propeller and rebalance or replace it if damaged
	Nut on prop shaft is too loose, causing excessive vibration	Tighten the prop shaft nut 1/2 turn
Aircraft does not connect to transmitter after battery is connected	Aircraft is not upright and immobile after battery is connected	Keep the Aircraft upright and immobile for 5 seconds after connecting the battery

Troubleshooting Guide

Problem	Possible Cause	Solution
Aircraft will not respond to throttle but responds to other controls	Throttle stick and/or throttle trim is too high	Reset controls with throttle stick and throttle trim at lowest setting
	Throttle channel is reversed	Reverse throttle channel on transmitter
	Motor is disconnected from receiver	Open fuselage and ensure the plug for the motor is properly installed
Extra propeller noise or extra vibration	Damaged propeller, prop shaft or motor	Replace damaged parts
	Nut on prop shaft is too loose	Tighten the prop shaft nut 1/2 turn

Problem	Possible Cause	Solution
Reduced flight time or aircraft underpowered	Flight battery charge is low	Completely recharge flight battery
	Propeller is installed backwards	Install propeller with numbers facing forward
	Flight battery is damaged	Replace flight battery and follow flight battery instructions
	Flight conditions may be too cold	Make sure battery is warm before use
	Battery capacity is too low for flight conditions	Replace battery or use a larger capacity battery
LED on receiver flashes rapidly and aircraft will not bind to transmitter (during binding)	Transmitter is too near aircraft during binding process	Power off transmitter, move transmitter a larger distance from aircraft, disconnect and reconnect flight battery to aircraft and follow binding instructions
	Bind switch or button was not held while transmitter was powered on	Power off transmitter and repeat bind process
	Aircraft or transmitter is too close to large metal object, wireless source or another transmitter	Move aircraft and transmitter to another location and attempt binding again
LED on receiver flashes rapidly and aircraft will not respond to transmitter (after binding)	Less than a 5-second wait between first powering on transmitter and connecting flight battery to aircraft	Leaving transmitter on, disconnect and reconnect flight battery to aircraft
	Aircraft is bound to a different model memory (ModelMatch™ radios only)	Select correct model memory on transmitter and disconnect and reconnect flight battery to aircraft
	Flight battery/transmitter battery charge is too low	Replace/recharge batteries
	Transmitter may have been bound to a different model (or with a different DSM Protocol)	Select the right transmitter or bind to the new one
	Aircraft or transmitter is too close to large metal object, wireless source or another transmitter	Move aircraft and transmitter to another location and attempt connecting again
Control surface does not move	Control surface, control horn, linkage or servo damage	Replace or repair damaged parts and adjust controls
	Wire damaged or connections loose	Perform a wire and connection check; connect or replace as needed
	Flight battery charge is low	Fully recharge flight battery
	Control linkage does not move freely	Make sure control linkage moves freely
Controls reversed	Transmitter settings reversed	Perform the Control Direction Test and adjust controls on transmitter appropriately
Motor loses power	Damage to motor or power components	Do a check of motor and power components for damage (replace as needed)
	Prop shaft nut is too tight	Loosen prop shaft nut until propeller shaft turns freely
Motor power pulses then loss of power	Battery power is down to the point of receiver/ESC Low Voltage Cutoff (LVC)	Recharge flight battery or replace battery that is no longer performing
Servo locks or freezes at full travel	Travel adjust value is set above 100% overdriving the servo	Set Travel adjust to 100% or less and/or set sub trims to Zero and adjust linkages mechanically

Replacement Parts

Part #	Description
SPMA3178	Sport Cub S Receiver/ESC
EFLB1501S25	150mAh 1S 3.7V 25C Li-Po battery
EFLC1008	1S USB Li-Po Charger, 300mA
HBZ4406	Landing Gear Set: Sport Cub
HBZ4420	Wing: Sport Cub
HBZ4413	Decal Sheet: Sport Cub
HBZ44520	Fuse w/electronics: Sport Cub
HBZ4467	Bare Fuselage: Sport Cub
HBZ4431	Tail Set: Sport Cub
HBZ4401	Prop and Spinner: Sport Cub
HBZ4429	Motor: Sport Cub
HBZ4430	Complete Gear Box: Sport Cub
HBZ4421	Pushrod/Control Horns: Sport Cub
HBZ4404	Prop Shaft: Sport Cub
SPMSA2030L0	2.3-Gram Linear Long Throw Offset Servo
SPMRMLP6	MLP6DSM SAFE Transmitter Mode 2
SPMRMLP61	MLP6DSM SAFE Transmitter Mode 1

Optional Parts

Part #	Description
EFLUA1190	Float Set: UMX Carbon Cub SS
EFLB1501S45	150mAh 1S 3.7V 45C LiPo Battery
SPMXC1040	S44 4 Port AC/DC 1S LiPo Charger
SPMXC1060	S63 6 Port USB 1S LiPo Charger
SPMR1000	DXe Transmitter
SPMR8000	DX8 Transmitter
SPMR6750	DX6 Transmitter

Limited Warranty

What this Warranty Covers — Horizon Hobby, LLC (Horizon) warrants to the original purchaser that the product purchased (the "Product") will be free from defects in materials and workmanship at the date of purchase

What is Not Covered — This warranty is not transferable and does not cover (i) cosmetic damage, (ii) damage due to acts of God, accident, misuse, abuse, negligence, commercial use, or due to improper use, installation, operation or maintenance, (iii) modification of or to any part of the Product, (iv) attempted service by anyone other than a Horizon Hobby authorized service center, (v) Product not purchased from an authorized Horizon dealer, (vi) Product not compliant with applicable technical regulations, or (vii) use that violates any applicable laws, rules, or regulations.

OTHER THAN THE EXPRESS WARRANTY ABOVE, HORIZON MAKES NO OTHER WARRANTY OR REPRESENTATION, AND HEREBY DISCLAIMS ANY AND ALL IMPLIED WARRANTIES, INCLUDING, WITHOUT LIMITATION, THE IMPLIED WARRANTIES OF NON-INFRINGEMENT, MERCHANTABILITY AND FITNESS FOR A PARTICULAR PURPOSE. THE PURCHASER ACKNOWLEDGES THAT THEY ALONE HAVE DETERMINED THAT THE PRODUCT WILL SUITABLY MEET THE REQUIREMENTS OF THE PURCHASER'S INTENDED USE.

Purchaser's Remedy — Horizon's sole obligation and purchaser's sole and exclusive remedy shall be that Horizon will, at its option, either (i) service, or (ii) replace, any Product determined by Horizon to be defective. Horizon reserves the right to inspect any and all Product(s) involved in a warranty claim. Service or replacement decisions are at the sole discretion of Horizon. Proof of purchase is required for all warranty

claims. SERVICE OR REPLACEMENT AS PROVIDED UNDER THIS WARRANTY IS THE PURCHASER'S SOLE AND EXCLUSIVE REMEDY.

Limitation of Liability — HORIZON SHALL NOT BE LIABLE FOR SPECIAL, INDIRECT, INCIDENTAL OR CONSEQUENTIAL DAMAGES, LOSS OF PROFITS OR PRODUCTION OR COMMERCIAL LOSS IN ANY WAY, REGARDLESS OF WHETHER SUCH CLAIM IS BASED IN CONTRACT, WARRANTY, TORT, NEGLIGENCE, STRICT LIABILITY OR ANY OTHER THEORY OF LIABILITY, EVEN IF HORIZON HAS BEEN ADVISED OF THE POSSIBILITY OF SUCH DAMAGES. Further, in no event shall the liability of Horizon exceed the individual price of the Product on which liability is asserted. As Horizon has no control over use, setup, final assembly, modification or misuse, no liability shall be assumed nor accepted for any resulting damage or injury. By the act of use, setup or assembly, the user accepts all resulting liability. If you as the purchaser or user are not prepared to accept the liability associated with the use of the Product, purchaser is advised to return the Product immediately in new and unused condition to the place of purchase.

Law — These terms are governed by Illinois law (without regard to conflict of law principals). This warranty gives you specific legal rights, and you may also have other rights which vary from state to state. Horizon reserves the right to change or modify this warranty at any time without notice.

WARRANTY SERVICES

Questions, Assistance, and Services — Your local hobby store and/or place of purchase cannot provide warranty support or service. Once assembly, setup or use of the Product has been started, you must contact

your local distributor or Horizon directly. This will enable Horizon to better answer your questions and service you in the event that you may need any assistance. For questions or assistance, please visit our website at www.horizonhobby.com, submit a Product Support Inquiry, or call the toll free telephone number referenced in the Warranty and Service Contact Information section to speak with a Product Support representative.

Inspection or Services — If this Product needs to be inspected or serviced and is compliant in the country you live and use the Product in, please use the Horizon Online Service Request submission process found on our website or call Horizon to obtain a Return Merchandise Authorization (RMA) number. Pack the Product securely using a shipping carton. Please note that original boxes may be included, but are not designed to withstand the rigors of shipping without additional protection. Ship via a carrier that provides tracking and insurance for lost or damaged parcels, as Horizon is not responsible for merchandise until it arrives and is accepted at our facility. An Online Service Request is available at http://www.horizonhobby.com/content/service-center_render-service-center. If you do not have internet access, please contact Horizon Product Support to obtain a RMA number along with instructions for submitting your product for service. When calling Horizon, you will be asked to provide your complete name, street address, email address and phone number where you can be reached during business hours. When sending product into Horizon, please include your RMA number, a list of the included items, and a brief summary of the problem. A copy of your original sales receipt must be included for warranty consideration. Be sure your name, address, and RMA number are clearly written on the outside of the shipping carton.

Warranty Requirements — For Warranty consideration, you must include your original sales receipt verifying the proof-of-purchase date. Provided warranty conditions have been met, your Product will be serviced or replaced free of charge. Service or replacement decisions are at the sole discretion of Horizon.

Non-Warranty Service — Should your service not be covered by warranty, service will be completed and payment will be required without notification or estimate of the expense unless the expense exceeds 50% of the retail purchase cost. By submitting the item for service you are agreeing to payment of the service without notification. Service estimates are available upon request. You must include this request with your item submitted for service. Non-warranty service estimates will be billed a minimum of ½ hour of labor. In addition you will be billed for return freight. Horizon accepts money orders and cashier's checks, as well as Visa, MasterCard, American Express, and Discover cards. By submitting any item to Horizon for service, you are agreeing to Horizon's Terms and Conditions found on our website: http://www.horizonhobby.com/content/service-center_render-service-center.

ATTENTION: Horizon service is limited to Product compliant in the country of use and ownership. If received, a non-compliant Product will not be serviced. Further, the sender will be responsible for arranging return shipment of the un-serviced Product, through a carrier of the sender's choice and at the sender's expense. Horizon will hold non-compliant Product for a period of 60 days from notification, after which it will be discarded.

10/15

NOTICE: Do not ship LiPo batteries to Horizon. If you have any issue with a LiPo battery, please contact the appropriate Horizon Product Support office.

Warranty and Service Information

Country of Purchase	Horizon Hobby	Contact Information	Address
United States of America	Horizon Service Center (Repairs and Repair Requests)	servicecenter.horizonhobby.com/ RequestForm/	2904 Research Rd Champaign, Illinois 61822 USA
	Horizon Product Support (Product Technical Assistance)	productsupport@horizonhobby.com 877-504-0233	
	Sales	websales@horizonhobby.com 800-338-4639	
EU	Horizon Technischer Service	service@horizonhobby.eu	Hanskampring 9 D 22885 Barsbüttel Germany
	Sales: Horizon Hobby GmbH	+49 (0) 4121 2655 100	

FCC Information

FCC ID: BRWWAC01T

This device complies with part 15 of the FCC rules. Operation is subject to the following two conditions: (1) This device may not cause harmful interference, and (2) this device must accept any interference received, including interference that may cause undesired operation.



CAUTION: Changes or modifications not expressly approved by the party responsible for compliance could void the user's authority to operate the equipment.

This product contains a radio transmitter with wireless technology which has been tested and found to be compliant with the applicable regulations governing a radio transmitter in the 2.400GHz to 2.4835GHz frequency range.

Supplier's Declaration of Conformity



Hobbyzone Sport Cub S 2 RTF/BNF (HBZ44000 / HBZ44500)

This device complies with part 15 of the FCC Rules. Operation is subject to the following two conditions: (1) This device may not cause harmful interference, and (2) this device must accept any interference received, including interference that may cause undesired operation.



CAUTION: Changes or modifications not expressly approved by the party responsible for compliance could void the user's authority to operate the equipment.

NOTE: This equipment has been tested and found to comply with the limits for a Class B digital device, pursuant to part 15 of the FCC Rules. These limits are designed to provide reasonable protection against harmful interference in a residential installation. This equipment generates, uses and can radiate radio frequency energy and, if not installed and used in accordance with the instructions, may cause harmful interference to radio communications. However, there is no guarantee that interference will not occur in a particular installation. If this equipment does cause harmful interference to radio or television reception, which can be determined by turning the equipment off and on, the user is encouraged to try to correct the interference by one or more of the following measures:

- Reorient or relocate the receiving antenna.
- Increase the separation between the equipment and receiver.
- Connect the equipment into an outlet on a circuit different from that to which the receiver is connected.
- Consult the dealer or an experienced radio/TV technician for help.

Horizon Hobby, LLC
2904 Research Rd.
Champaign, IL 61822
Email: compliance@horizonhobby.com
Web: HorizonHobby.com

IC Information

IC: 6157A-WAC01T

This device complies with Industry Canada license-exempt RSS standard(s). Operation is subject to the following two conditions: (1) this device may not cause interference, and (2) this device must accept any interference, including interference that may cause undesired operation of the device.

Compliance Information for the European Union



EU Compliance Statement: Horizon Hobby, LLC hereby declares that this product is in compliance with the essential requirements and other relevant provisions of the RED, EMC, and LVC directives.

A copy of the EU Declaration of Conformity is available online at:
<http://www.horizonhobby.com/content/support-render-compliance>.

Frequency: 2402-2478 MHz

Max EIRP: 20dBm



Instructions for disposal of WEEE by users in the European Union

This product must not be disposed of with other waste. Instead, it is the user's responsibility to dispose of their waste equipment by handing it over to a designated collections point for the recycling of waste electrical and electronic equipment. The separate collection and recycling of your waste equipment at the time of disposal will help to conserve natural resources and ensure that it is recycled in a manner that protects human health and the environment. For more information about where you can drop off your waste equipment for recycling, please contact your local city office, your household waste disposal service or where you purchased the product.



© 2020 Horizon Hobby, LLC

HobbyZone, the HobbyZone logo, E-flite, SAFE, the SAFE logo, DSM, DSM2, DSMX, IC3, Bind-N-Fly, the BNF logo, and the Horizon Hobby logo are trademarks or registered trademarks of Horizon Hobby, LLC.

The Spektrum trademark is used with permission of Bachmann Industries, Inc.

US 9,930,567. US 10,419,970. US 9,056,667. US 9,753,457. US 10,078,329.

US 8,672,726. US 7,898,130. D578,146.

www.horizonhobby.com